

meridian

**Meridian 8314
Installation and
User Guide**

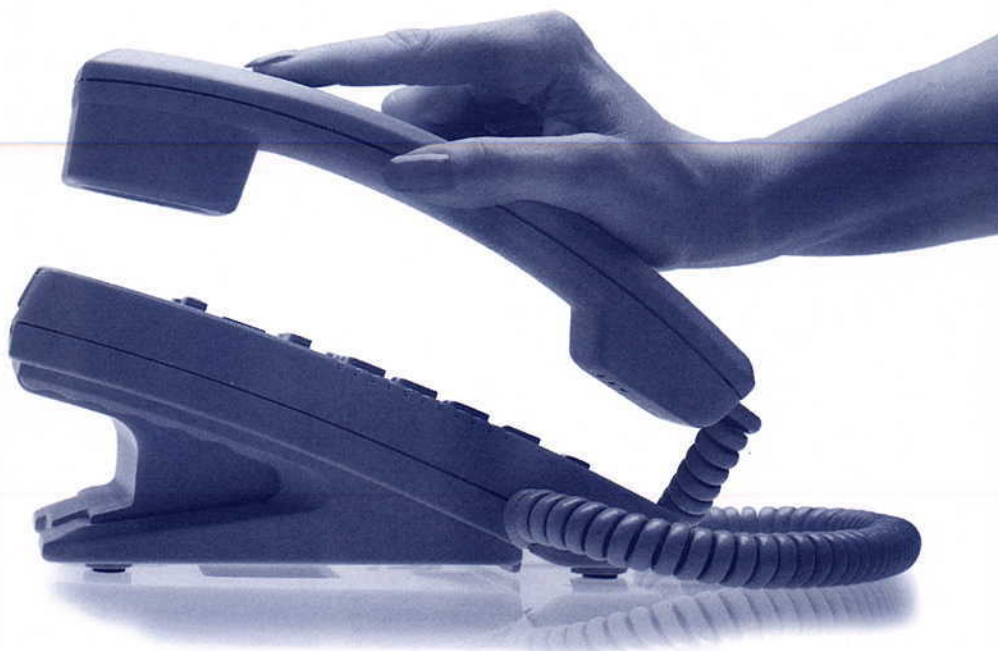

GTE

***Meridian 8314
Installation and
User Guide***

Meridian is a trademark of Northern Telecom
© Copyright Northern Telecom 1995

Table of Contents

Key Descriptions	2	Memory keys	14
Basic Installation	4	Saving numbers and names in memory keys	14
Connecting the handset cord	4	Saving from the display into memory keys	14
Connecting the line cord on Line 1	4	Labeling the memory keys	15
Connecting the power adaptor	5	Making calls from memory keys	15
Checking your telephone	5	Editing memory keys	15
Connecting an optional fax peripheral	5	Deleting memory keys	16
Optional Wall Mounting	6	Saving features in memory keys	16
Basic Features	7	Using feature keys	16
Making a call	7	Saving a feature and light in memory keys	17
Answering a call	7	Using FeatureLight keys	17
Making a handsfree call	8	Advanced Features	18
Putting a call on mute	8	Adding a timer key	18
Using the Redial List	8	Using the Call Timer	18
Telephone Setup	9	Deleting a timer key	18
Changing the display language	9	Selecting the dial pad mode	19
Setting the date and time	9	Extension in use	19
Turning the ringer ON and OFF	10	Display messages and lights	19
Setting the ring tone and ringer volume	10	Knowing when you have a message	19
Controlling the ringer volume	10	Viewing multiple display and light messages	19
Controlling the receiver volume	10	Learning about the lights	20
Controlling the speaker volume	10	Set indicator light messages	20
Directory	11	Handsfree light messages	20
Saving numbers and names to the Directory	11	General display messages	21
Entering Names	12	Helpful Hints	22
Finding items in the Directory	12		
Making a call from the Directory	12		
Editing in the Directory	13		
Deleting items from the Directory	13		

Key Descriptions

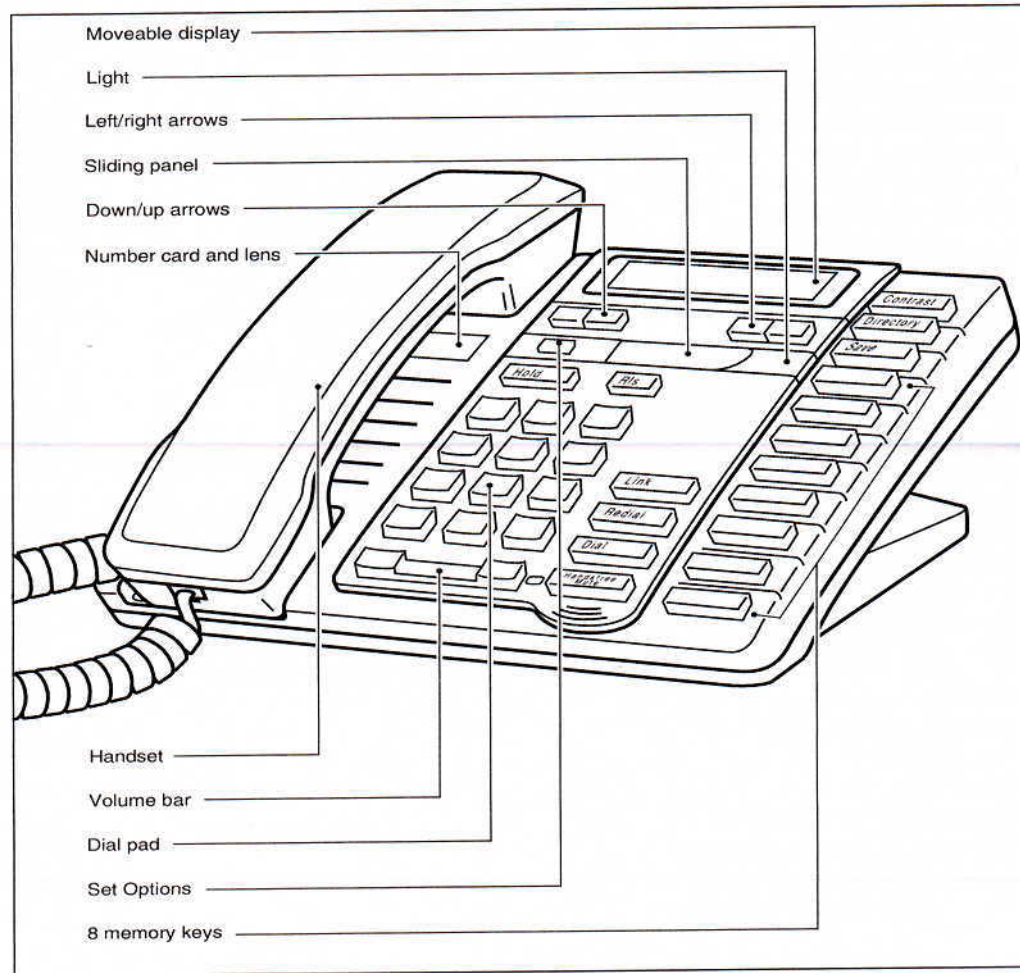

Contrast

Cycles through eight settings to adjust the display contrast.

Directory

Allows you to store and access up to 50 numbers and names.

Save

Stores numbers and names in the Directory and in memory keys.

↓ ↑

Allows you to move up and down any list such as the Set Options, Directory, or Redial List.

← □

Allows you to backspace and erase when predialing and when adding or changing numbers and names in the Directory or in memory keys.



Adds a space when entering names in the Directory or in memory keys. Allows you to view status messages on the display.



The unlabeled Set Options key is hidden under the sliding panel. This key gives you access to five options that customize the basic setup of your telephone.

Options	Page
1. Change display language	9
2. Set the date and time	9
3. Select the ring tone	10
4. Add a timer key	18
5. Select the dial pad mode	19

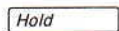

Puts the call on hold.



Always hangs up a call. Also lets you leave any list such as the Set Options List, Redial List, or Directory.



Allows you to access network features such as Call Waiting. Link is also referred to as Flash.



Allows you to access a list of the last five numbers you dialed.



Selects your line and dials any displayed number. Activates handsfree if you haven't lifted the handset.



Activates the speaker and microphone so you can listen and talk without lifting the handset.



Allows you to erase memory keys and delete items in the Directory.



Allows you to adjust the receiver, speaker, and ringer volume.





Memory keys store numbers, names, and features.

Basic Installation

This section contains the information you need to install your Meridian 8314 telephone.

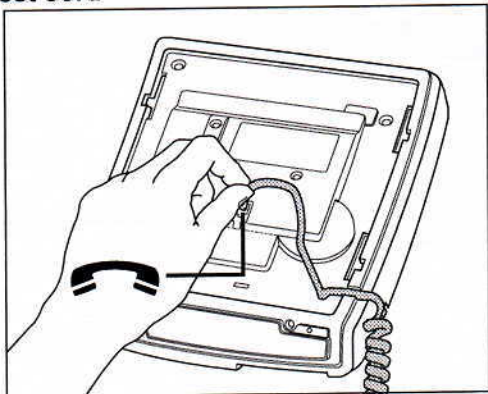
Connecting the handset cord



Attach the handset cord  .

Attach one end of the handset cord to the handset and the other end to the handset jack.

Connecting the line cord on Line 1.

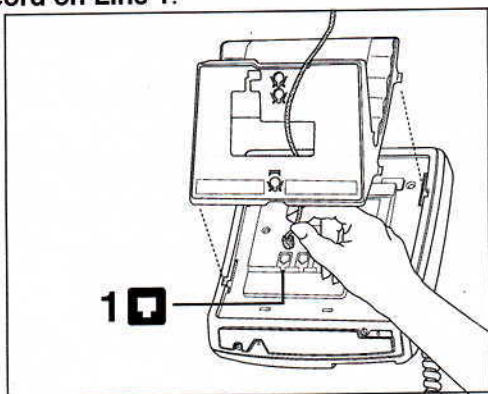

Attach the line cord in jack number 1, as shown by 1 .

Attach one end of the line cord to jack number 1 and the other end of the line cord to the wall jack.

Connecting the power adaptor

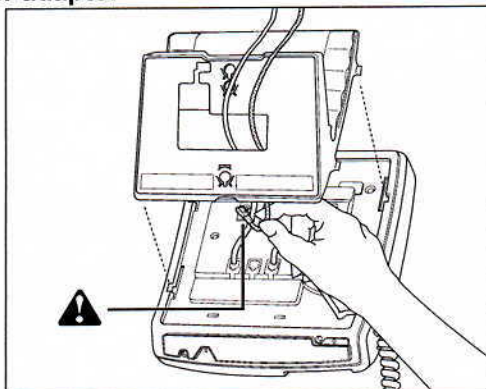

Attach the power adaptor cord ⚠

Attach the power adaptor to the base of the telephone, where the warning symbol is marked. Then connect the power adaptor into the closest electrical outlet.

Checking your telephone

When you first plug in your Meridian 8314, you may see a message asking you to make a language selection. Follow the directions on the display to select one of the languages.

Your telephone also runs a test to ensure that the line cords are connected properly. If the test fails, the display identifies which line is not connected. Make sure that all connections are fastened securely.

Connecting an optional fax peripheral

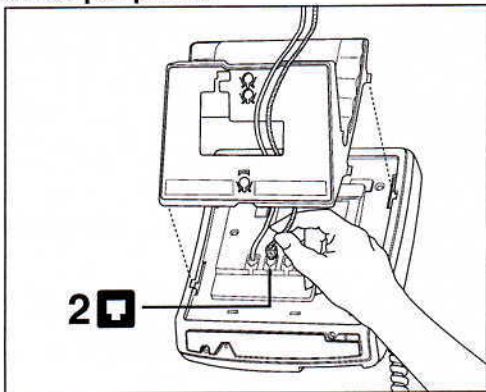

For your fax machine, answering machine or modem; attach the line cord in jack number 2 as shown by 2 □.

Attach one end of the line cord to jack number 2 and the other end of the line cord to the peripheral.

Optional Wall Mounting

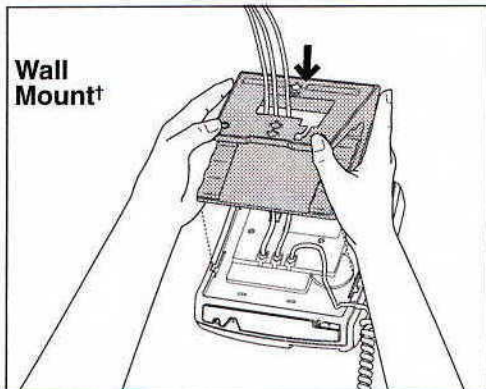
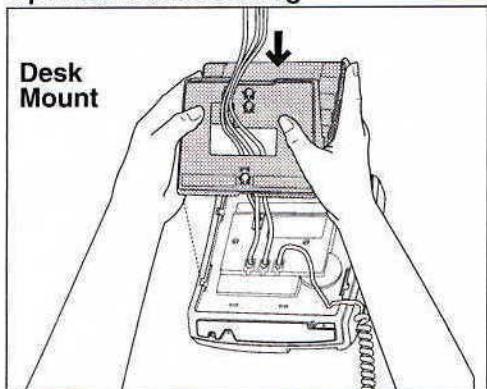

Lower the stand into the slots on the base of the telephone, as shown in the desk or wall mount illustration above.

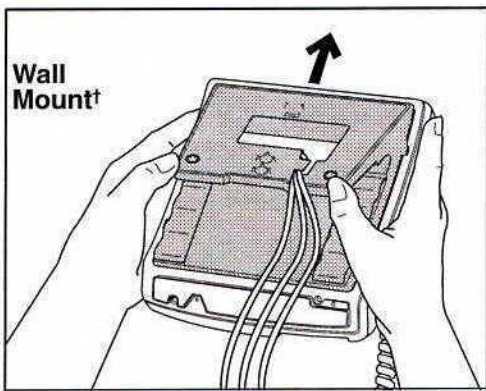
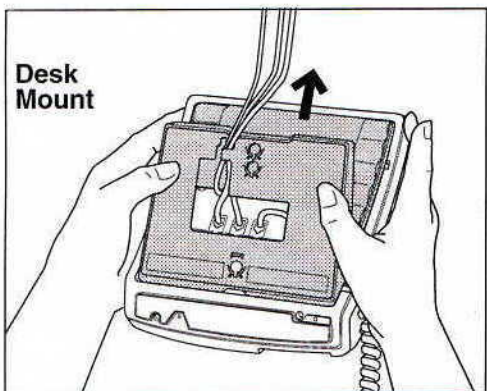

Slide the stand back until it clicks into the locked position, as shown in the desk or wall mount illustration above. The excess line cord fits into the stand of the telephone.

Note: The Load Number (LN) is 14 and the Ringer Equivalence Number (REN) is 1.4B for the Meridian 8314 telephone.

Please see the base of your telephone or the Regulations sheet for more regulatory and safety information.

†We recommend that you use a wall mounting plate, which your local telephone company can install.

Basic Features

Making a call

With the Meridian 8314 you can make a regular call or predial a telephone number. Predialing allows you to check the number before it is dialed out. Follow the procedures below to make a regular or predialed call.

To make a regular call:

1. Lift the handset.
2. Enter the number using the dial pad.

To make a predialed call:

1. Enter the number using the dial pad.
2. Lift the handset or press .

Answering a call

To answer a call:

1. Lift the handset or press or the key for the line you want to answer.

Putting a call on hold

When you put a call on hold it is important to hang up the handset.

To put a call on hold and take a call off hold:

1. Make or answer a call.
 2. Press . The display shows that the call is on hold.
 3. Hang up the handset.
 4. To retrieve the call, lift the handset or press either or .
- Note:** If you don't retrieve the call after 15 minutes, the call is automatically dropped.

Two things can happen if you don't hang up the handset after you have put a call on hold:

- When the call you have put on hold is picked up at another extension, the call remains connected to your telephone and is taken off hold. This means any background noise from your area will be heard by the caller and the other extension.
- If an incoming call is placed on hold and no one at another extension picks up the handset, the telephone will drop the held call after 15 minutes and re-establish dial tone.

Making a handsfree call

You can dial without using the handset or you can make a regular call and then talk without using the handset.

To dial without picking up the handset:

1. Press .
2. Enter the number using the dial pad.
3. When the call is over, hang up the handset or press .

To switch to a handsfree call:

1. Lift the handset.
2. Enter the number using the dial pad.
3. When the call is answered, press .
4. Hang up the handset.

Putting a call on mute

You can turn OFF the microphone so that the caller can't hear you but you can still hear the caller. This only works when you are on a handsfree call.

To mute a call:

1. Press .
2. Without lifting the handset, make a call.
3. To turn off the microphone, press again. You can hear your caller but your caller cannot hear you. The light beside flashes.
4. To speak to your caller, press again. Each time you press , you switch between handsfree and mute.
5. When the call is over, hang up the handset or press .

Using the Redial List

If you do not remember a number you just dialed, you can find it in the Redial List. The Redial key shows you a list of the last five numbers you called. Once you lift the handset, pressing automatically dials the last number.

To make a call from the Redial List:

1. Press . The display shows the last number you dialed.
2. Find the number you wish to call by pressing or .
3. When the number is displayed, lift the handset or press either or .

Telephone Setup

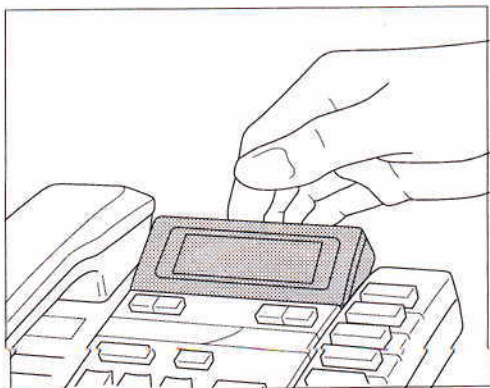

Place your Meridian 8314 on a table or hang it on a wall. Then adjust the display.

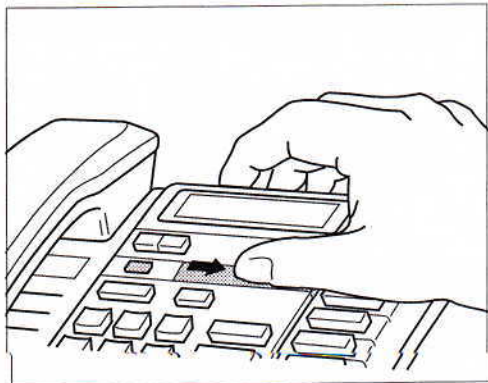





Move the sliding panel over to the right to reveal the Set Options key.

Changing the display language

For changing business requirements, you may wish to change the language of your display messages.





To change the display language:

1. Press the Set Options key.
2. Press   once or  to go directly to the item.
3. Press  to select the language.

Setting the date and time







You can manually set the date and time. You may have to reset the time and date after a power failure, for Daylight Savings time, and for leap years.

To set the date and time:





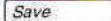

1. Press the Set Options key.
2. Press   twice or  to go directly to the item.
3. Press  and follow the instructions on the display.

Turning the ringer ON and OFF

To turn the ringer ON:

1. Press the right side of   .
2. Press the right side of   . Continue pressing the right hand side until you reach the desired ring volume.
3. Press .

To turn the ringer OFF:









1. Press the left side of   .
2. Press the left side of   . Continue pressing the left hand side until the ringer is off.
3. Press .
Ringer is OFF appears on the display.

Note: Do not lift the handset while you are turning the ringer ON or OFF.



Setting the ring tone and ringer volume

You can choose one of four different ring tones and set the ringer volume.



To set the ring tone and volume:

1. Make sure that the ringer is turned ON.
2. Press the Set Options key.
3. Press   three times or press .
4. Press  and follow the instructions on the display.
When picking the ring tone, press    to adjust the volume.
5. Press  to end only when you are satisfied with ring tone and ringer volume.



Controlling the ringer volume

While the telephone is ringing, you can press the left or right side of the volume bar    for soft or loud ringer volume.

Controlling the receiver volume

While you are on the telephone, you can press the left or right side of the volume bar    for soft or loud receiver volume.

Controlling the speaker volume

While you are listening through the speaker, you can press the left or right side of the volume bar    for soft or loud speaker volume.

Directory

The Meridian 8314 keeps the numbers and names of your business associates, clients, contacts, or friends at your fingertips. The Meridian 8314 lets you store up to 50 entries in alphabetical order so that you can dial numbers directly from the Directory.

The Directory orders the names by the first character. If you want your Directory sorted by the last name, enter the last name first. If you do not enter a name, the item is sorted by telephone number. The directory items with only a telephone number are at the beginning of the Directory.

Saving numbers and names to the Directory

To save a new number:

1. Press .

2. Press .

3. Enter the number using the dial pad.

4. Press . Only the number is stored at this point.

5. If you do not want a name, go to step 6. To enter a name, use the dial pad. (See **Entering Names** on page 12.)

6. Press .

To save a displayed number:

1. Ensure that a number is on the display. (For example, make a call using the dial pad, or use the Redial List or a memory key.)

2. Press .



3. Press . If the name is displayed with the number, both are now saved in the Directory.

4. If no name is displayed you are prompted to enter one. If you do not want a name, go to step 5. To enter a name, use the dial pad. (See **Entering Names** on page 12.)





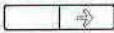





5. Press .



To backspace and erase a mistake, press . To insert a space press .

Entering Names

To program a name, find the dial pad key that has the first character of the name. Keep watching the display as you press the key until that character appears on the display. Press a different dial pad key for the next character. If the next character is on the same key, press  to move to the next space. To switch between upper and lower case letters, press .

For example: To enter the name **Ruth** press these keys:

   .    .  .  .  .

If you wish to change a digit or letter after you have entered it, press   to erase it.

 , - ' & . () 1

 A B C 2

 D E F 3

 G H I 4

 J K L 5

 M N O 6

 P Q R S 7

 T U V 8











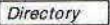







 W X Y Z 9

 * #

 0

Finding items in the Directory









To find items in the Directory:



1. To see the Directory List heading, press .
2. To see the listings that start with a particular letter, press the appropriate dial pad key. Then to see the other listings under that letter, press  . (For example:  takes you to the first "J" listing, then   takes you to the next "J" listing.   takes you to the first "K" listing.) Use the letter chart shown above.
OR, to move down and up the list, press   or  . If you want to scroll steadily, press and hold   or  .
3. To leave the Directory at any time, press  or .

Note: If you're on a call while you're viewing the Directory, pressing  also drops the call.

Making a call from the Directory

To make a call from the Directory:

1. Press .
2. Press   or   or use the dial pad to find the item you want to dial out.
3. Lift the handset or press either  or .
4. To end the call, press  or hang up.

Note: To leave the Directory at any time, press  or .

If you're on a call while you are viewing the Directory, pressing  also drops the call.

Editing in the Directory

To edit a number and/or name in the Directory:

1. Press .
2. Press or to find the item you want to edit.
3. To begin editing, press .
4. If you do not want to change the number, go to step 5. To backspace and erase digits, press . To add digits, use the dial pad.
5. Press .
6. If you do not want to change the name, go to step 7. To change or add to the name, use and the dial pad. (See **Entering Names** on page 12.)
Note: If you edit the wrong item or want to quit without saving changes, press or .
7. Press .

Deleting items from the Directory

To delete individual items:

1. Press .
2. Press or to find the item you want to delete.
3. Press twice. You are still in the directory.
4. Press or to exit the Directory at any time.

To delete all items:

1. Press .
2. Press twice.
3. To leave the Directory at any time, press or .

Memory keys

Saving numbers and names in memory keys

You can save the numbers and names of your customers, business associates, or anyone you call frequently in Meridian 8314's eight memory keys. You can store more numbers and names in the Directory. See the **Directory** section for more information.

To save a number and name:

1. Press .
2. Press the memory key where you want to save the number.
3. Enter the number using the dial pad. You can enter a maximum of 24 digits.
Note: If you require a pause (for example, between a telephone number and an access code), press where you want the pause.
4. Press .
5. To skip the name, go to step 6. To enter a name, use the dial pad.
(See **Entering Names** on page 12.)
6. Press .
7. Label the memory key. (See the diagram on page 15.)

Saving from the display into memory keys

To save from the display:

1. Ensure that a number is on the display. (For example, answer a call or make a call using the dial pad, or use the Redial List.)
2. Press .
3. Press the desired memory key. If the name was displayed with the number, both are now saved in the memory key.
4. If no name is displayed, you are prompted to enter one. If you don't want a name, go to step 5. To enter a name, use the dial pad. (See **Entering Names** on page 12.)
5. Press .
6. Label the memory key. (See the diagram on page 15.)

Labeling the memory keys

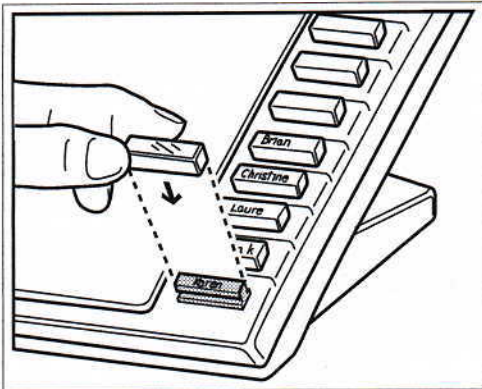
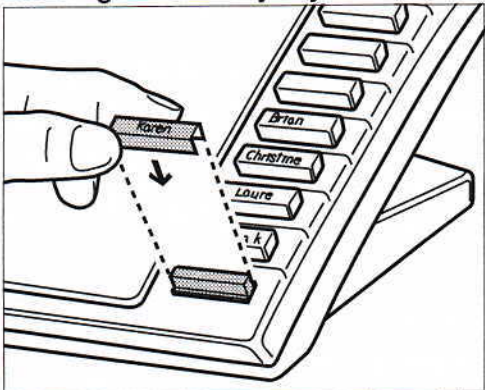



After programming the memory keys, label them with the supplied blank labels and key caps.†

Making calls from memory keys

To call from a memory key:





1. Lift the handset or press .
2. Press the memory key with the number you want to dial out.

To redial from a memory key:

1. Press the memory key with the number you want to dial out.
2. Lift the handset or press either  or .

Editing memory keys

To edit a memory key:

1. To see its contents, press the memory key.
2. Press .
3. If you don't want to change the number, go to step 4. To backspace and erase digits, press . To add digits, use the dial pad.
4. Press .
5. If you don't want to change the name, go to step 6. To add letters, use the dial pad. (See **Entering Names** on page 12.) To erase letters, press .
6. Press .

Note: The Live dial pad option must be turned OFF to edit memory keys. (See **Selecting the dial pad mode** on page 19).

† Keep key caps and the sliding panel away from small children. These small parts may come off the telephone if it is dropped.

Deleting memory keys

To delete a memory key:

1. To see its contents, press the memory key.
2. To erase, press twice.

Note: The Live dial pad option must be turned OFF to edit memory keys.

Saving features in memory keys

For easy access, you can save the feature codes of telephone company services in your memory keys. This works well with network features such as Call Forwarding, Call Screen, and Call Return. Some features require an ON and OFF code in two separate keys, while other features are stored on only one key. The following procedures show you how to save both an ON and OFF code.

To save a feature ON code:

1. Press .
2. Press the memory key where you want to save the number.
3. Enter the telephone company feature code for turning the feature ON.[†]

Read the display to confirm the number.

4. Press .
5. Enter the feature name using the dial pad. (See **Entering Names** on page 12.)
6. Press .
7. Label the memory key. (See the diagram on page 15.)

To save a feature OFF code:

1. Press .
2. Press the memory key where you want to save the number.
3. Enter the telephone company feature code for turning the feature OFF.[†]

Read the display to confirm the number.

4. Press .
5. Enter the feature name using the dial pad. (See **Entering Names** on page 12.)
6. Press .
7. Label the memory key. (See the diagram on page 15.)

[†]**Note:** Contact your telephone company or Telecom manager for the appropriate feature codes.

Using feature keys

When a memory key is programmed with a feature code, you can use the memory key to activate or deactivate the feature.

To turn a feature ON or OFF:

1. Press the memory key where you stored the desired feature. The display shows the feature name and code.
 2. Lift the handset or press either or .
- The feature code is dialed out, which turns the feature ON or OFF.

Saving a feature and light in memory keys

You can make the set indicator light come ON when you turn a feature ON and go OFF when you turn that same feature OFF. You can only do this with one feature. This works well with any service that has separate ON and OFF codes such as Call Forwarding.

For example, you may want the light to remind you that you have turned Call Forwarding ON. To do this, use one key to turn the indicator light ON when you activate the feature. Use the second key to turn the indicator light OFF when you deactivate that same feature. The following procedure shows you how to program a FeatureLight ON and OFF key.

To save a FeatureLight ON key:

1. Press . Do NOT select a memory key yet.
2. To program the light ON, press .
3. Press the desired memory key.
4. Enter the telephone company feature code for turning the feature ON.[†]

Read the display to confirm the number.

5. Press .
6. Label the memory key.
(See the diagram on page 15.)

To save a FeatureLight OFF key:

1. Press . Do NOT select a memory key yet.
2. To program the light OFF, press .
3. Press the desired memory key.
4. Enter the telephone company feature code for turning the feature OFF.[†]

Read the display to confirm the number.

5. Press .
6. Label the memory key.
(See the diagram on page 15.)

[†]**Note:** Contact your telephone company or Telecom manager for the appropriate feature codes.

Using FeatureLight keys

To turn a feature and light ON or OFF:

1. Press the memory key where you stored the FeatureLight.
The display shows **FeatureLight ON** or **FeatureLight OFF**.
 2. Lift the handset or press either or .
- The feature and light turn ON or OFF. (When the feature and light are ON and you're not using the telephone, the display shows **Feature ON** as a reminder.)

Advanced Features

Adding a timer key

You can program any of the memory keys to be a timer key.

To add a timer key:

1. Press the Set Options key.
2. Press four times, or press to go directly to the item.
3. Press to add a Timer key.
4. Press a memory key.
5. Press .
6. Label the timer key. (See the diagram on page 15.)

Using the Call Timer

You can program a memory key to time the length of a call. The timer starts and stops timing each call automatically.

To show the timer on the display:

1. Make or answer a call. The timer starts running automatically.
2. Once on the call, press the timer key.
The display shows the running time of the call.
3. To return to the call information display, press the timer key again.
4. When the call is over, hang up the handset or press . The timer stops counting.

Note: To show the elapsed time of the most recent call (or last call) when you're not on a call, press the timer key.

Deleting a timer key

To delete a timer key

1. Press the timer key.
2. Press twice.

Selecting the dial pad mode

When you select the dial pad mode, you are turning the Live dial pad option on or off. With Live dial pad ON, the telephone automatically dials out and turns on handsfree as soon as you press a dial pad key or a memory key. When Live dial pad is OFF, the telephone is in regular or predial mode. This means after you dial the telephone number you must lift the handset or press either

or before the telephone number is dialed.

To select the dial pad mode:

1. Press the Set Options key.
2. Press five times or press to go directly to the item.
3. Press to change the dial pad mode from Live dial pad OFF to ON or ON to OFF.

Extension in use

When you lift the handset or press , the Meridian 8314 telephone automatically selects the prime line. If another person on an extension telephone picks up the handset, the indicator light comes ON and the message **Extension in use** appears on the display. The light remains ON until the other person hangs up.

Display messages and lights

Knowing when you have a message

The Meridian 8314's set indicator light lets you know that your voice mail system has a message for you. The set indicator light flashes slowly and the display shows

Message Waiting

after your voice mail has received a call. Contact your local telephone company to find out how you can subscribe to message waiting services.

Viewing multiple display and light messages

When you aren't using the telephone, there are up to four messages that can be active at any time: date and time, **Feature ON**, **Message Waiting**, and **Ringer is OFF**. When more than one of these messages is active, the display shows the most recent message and → in the bottom right-hand corner. You can view the other messages by pressing . Each time you press , the display shows the next active message and its associated light. You can leave any one of the active messages on the display.

Learning about the lights

The set indicator light also alerts you when another extension is on the line, the telephone rings, or a feature is ON. There are also indicator lights beside the line keys and  to show you the status of the lines and of handsfree and mute.

Set indicator light messages

Feature	Light
Call is on hold	Indicator light flashes quickly.
Extension in use	Indicator light is ON.
Feature ON	Indicator light is ON.
Message Waiting	Indicator light flashes slowly.
Ringer is OFF	Indicator light is OFF.
Visual Ringing	Indicator light flashes very quickly.

Handsfree light messages

Feature	Light
Call is on handsfree	Handsfree/Mute light is ON.
Microphone is muted	Handsfree/Mute light flashes quickly.

General display messages

Message	What it means
Check line cord	If there is no dial tone, make sure the line cord and handset cord are attached securely.
Directory empty Use SAVE to add	The Directory remains empty until you add numbers and names to it.
Directory full No changes made	The Directory has a 50 entry limit. If you want to add an item, delete an item you no longer use.
Extension in use	An extension telephone is using the same line that you want to use. Select the other line instead. Or, someone is trying to use the same line on an extension telephone.
Feature ON	The FeatureLight ON key has been pressed and the code dialed out. To turn OFF the feature and the light, press the FeatureLight OFF key and lift the handset or press either <input type="button" value="Handfree Mute"/> or <input type="button" value="Dial"/> .
Key is locked	The memory key is factory programmed and cannot be erased or reprogrammed. Program a different memory key.
Message Waiting	Your voice mail service has received a call for you. To subscribe to voice mail service contact your telephone company.
Redial list is empty	This appears if you press <input type="button" value="Redial"/> before making any calls on your telephone or if power has been interrupted.
Ringer is OFF	The ringer volume is turned OFF for that line. Without lifting the handset, press the volume bar.
...xxxxxxxxxxxxxxxxxxx	The telephone number is longer than the display. The display shows ... and the last 15 digits of the number.

Helpful Hints

The display is in the alternate language.

You can change to the other language by pressing twice.

The cursor doesn't move when saving in the Directory.

The number or name is too long. Numbers can be no longer than 24 digits and names can be no longer than 16 characters.

You cannot save a Directory number into a memory key.

You cannot save Directory items into memory keys. Once you are in the Directory, can only add an item to the Directory.

There is no information on the display and the ringer volume is low.

Make sure the power adaptor is plugged in a working electrical outlet.

You cannot hear a caller or be heard.

Make sure the handset cord is inserted securely into the jack and make sure the receiver volume is high enough.

The power is out and the display is blank.

Meridian 8314 still operates as a regular telephone during a power failure. You can dial using the dial pad and you can receive calls, but the other keys and the display do not operate until the power is restored.

The display works but you can't hear dial tone.

Your telephone lines may be wired differently from the telephone jack. To have a service person correct the wiring, contact your local telephone company or Telecom manager.

The telephone wobbles.

Check that the handset cord is placed in the channel between the stand and the telephone. See the illustration on page 4.

You cannot program a memory key.

Some of the memory keys may be factory-programmed. These keys are locked and cannot be erased or reprogrammed.