

**Notice of Meeting  
UNIVERSITY OF HAWAI'I**

**BOARD OF REGENTS COMMITTEE ON RESEARCH AND INNOVATION**

Members: Regents Sullivan (Chair), Bal (Vice-Chair), Higa, Wilson, and Yuen

**Date:** Wednesday, October 3, 2018  
**Time:** 10:00 a.m.  
**Place:** University of Hawai'i at Mānoa  
Information Technology Building  
1<sup>st</sup> Floor Conference Room 105A/B  
2520 Correa Road  
Honolulu, Hawai'i 96822

**AGENDA**

**I. Call Meeting to Order**

**II. Approval of Minutes of the May 24, 2018 Meeting**

**III. Public Comment Period for Agenda Items:** All written testimony on agenda items received after posting of this agenda and up to 24 hours in advance of the meeting will be distributed to the board. Late testimony on agenda items will be distributed to the board within 24 hours of receipt. Written testimony may be submitted via US mail, email at [bor@hawaii.edu](mailto:bor@hawaii.edu), or facsimile at 956-5156. Individuals submitting written testimony are not automatically signed up for oral testimony. Registration for oral testimony on agenda items will be provided at the meeting location 15 minutes prior to the meeting and closed once the meeting begins. Oral testimony is limited to three (3) minutes. All written testimony submitted are public documents. Therefore, any testimony that is submitted verbally or in writing, electronically or in person, for use in the public meeting process is public information and will be posted on the board's website.

**IV. Agenda Items**

A. For Information and Discussion:

1. Research & Innovation Year in Review and FY19 Outlook
2. Applied Research Laboratory Status Report
3. Strategic Directions – Extramural Awards Targets vs. Actuals
4. Research Faculty – Current Hiring and Comparative Data
5. Update on Mānoa Innovation Center

B. For Review and Approval:

1. Approval of Committee Goals and Objectives

**V. Adjournment**



UNIVERSITY 18 SEP 28 12:06  
of HAWAII\*  
SYSTEM

Office of the Vice President for Research and Innovation

UH DTS # 19121

RECEIVED

'18 SEP 28 A11 :57

September 27, 2018

**MEMORANDUM**

UNIVERSITY OF HAWAII  
PRESIDENT'S OFFICE

**TO:** Jan Sullivan, Chairperson  
BOR Committee on Research and Innovation

**VIA:** David Lassner  
President

**FROM:** Vassilis L. Syrmos   
Vice President for Research and Innovation

**SUBJECT:** **BOR COMMITTEE ON RESEARCH AND INNOVATION AGENDA MATERIALS  
FOR OCTOBER 2018 MEETING**

Please find attached the following materials that will be discussed at the October 3, 2018 BOR Committee on Research and Innovation meeting:

A. For Information & Discussion:

1. Research and Innovation FY18 Year in Review and FY19 Outlook (*\*VPRI presentation*)
  - a. FY18 Q4 Extramural Awards Analysis Report
  - b. FY18 Q4 Research and Innovation Metrics Summary
  - c. FY18 Monthly Report of Extramural Awards (as of June 30, 2018)
  - d. 2018 Annual Report: Extramural Awards & Expenditures
2. Applied Research Laboratory (ARL) Status Report (*\*ARL Associate Director presentation*)
3. Strategic Directions – Extramural Awards Targets vs. Actuals (*\*VPRI presentation*)
4. Research Faculty – Current Hiring Policy and Comparative Data (*\*VPRI presentation*)
5. Mānoa Innovation Center Update (*\*VPRI presentation*)

Attachments

# Research & Innovation FY18 Year in Review and FY19 Outlook

---

BOR Research & Innovation Committee



# Overview

---

- FY 18 Performance Metrics
  - Extramural awards
  - Disclosures; patents; licenses; start-up companies
- FY 19 Projection
- Appendix (other metrics)

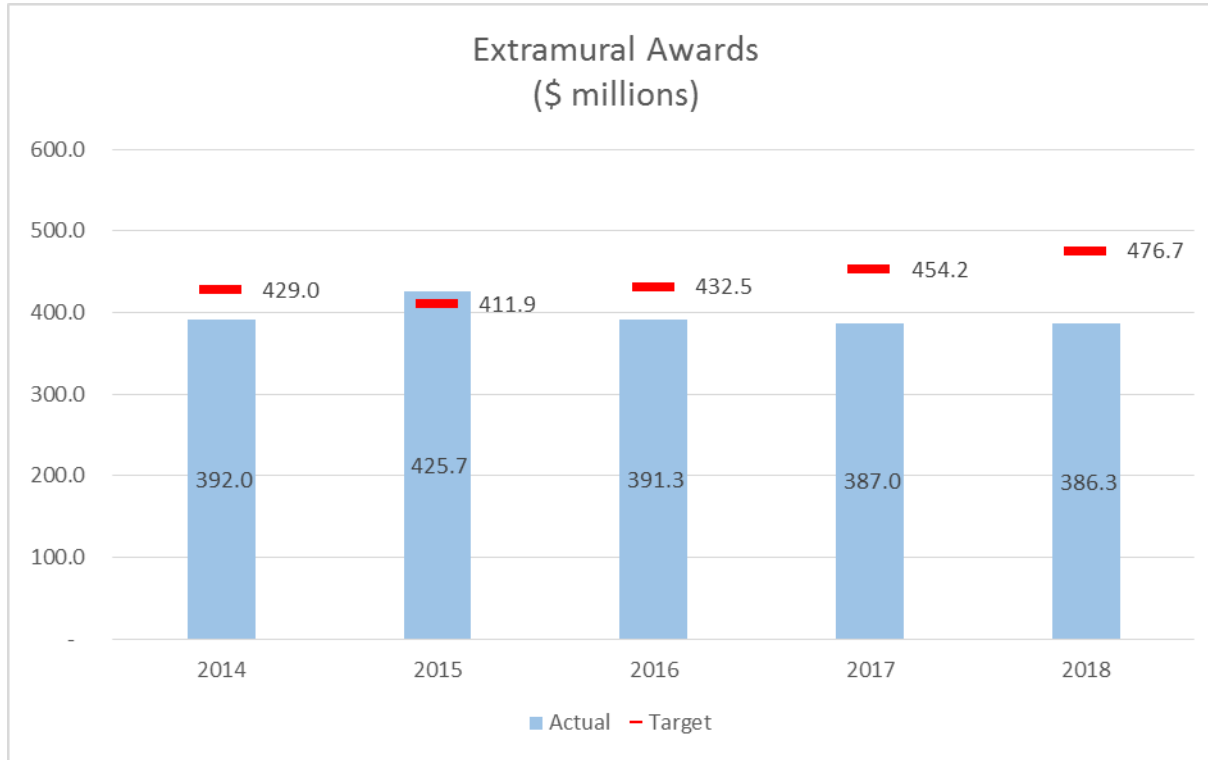

	FY 2016		FY 2017		FY 2018	
	Target	Actual	Target	Actual	Target	Actual
Extramural Awards (\$ millions)	432.5	🟡 391.3	454.2	🔴 387.0	476.7	🔴 386.3



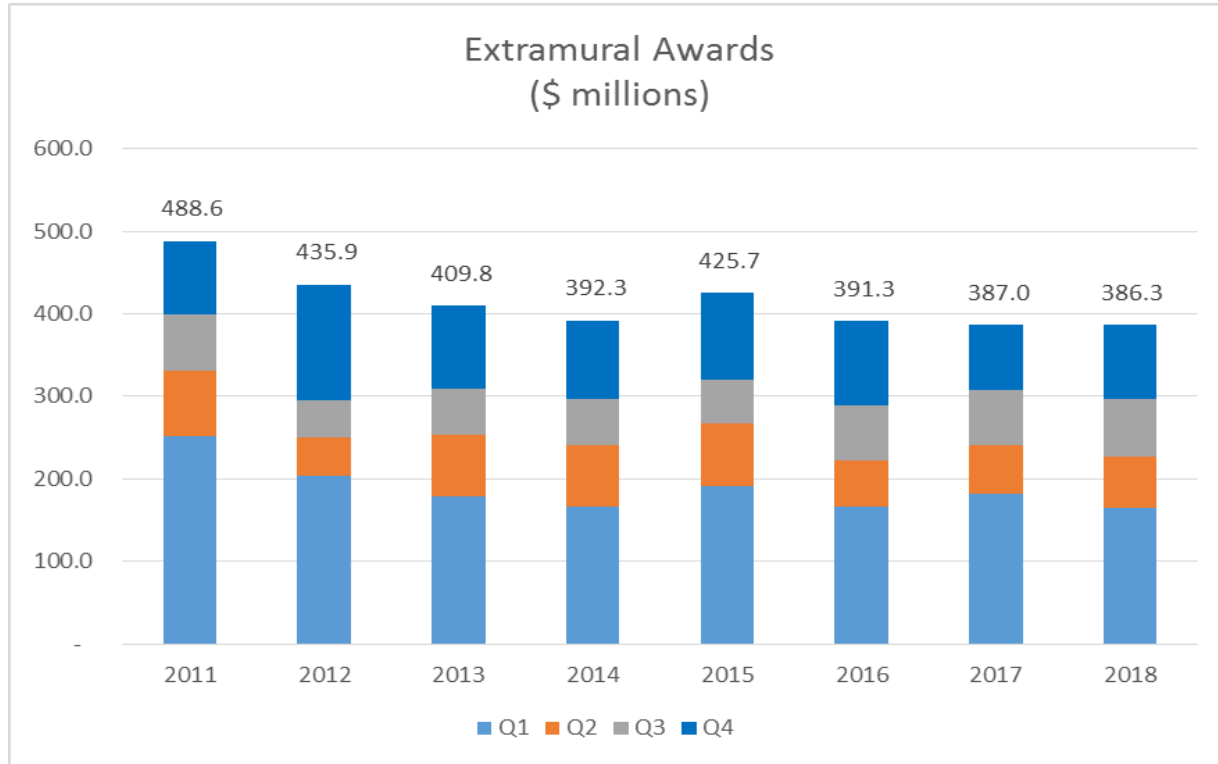

	2011	2012	2013	2014	2015	2016	2017	2018
Q1	251.5	203.2	178.1	166.5	191.1	165.8	181.8	164.5
Q2	78.8	47.5	74.8	74.7	77.0	56.9	59.5	62.0
Q3	68.8	45.3	56.7	55.4	52.8	66.2	67.1	71.0
Q4	89.5	139.9	100.1	95.7	104.8	102.4	78.6	88.8
<b>FY</b>	<b>488.6</b>	<b>435.9</b>	<b>409.8</b>	<b>392.3</b>	<b>425.7</b>	<b>391.3</b>	<b>387.0</b>	<b>386.3</b>



# Federal R&D Budget '14 – '18

<b>Total R&amp;D by Agency, FY 2014-2018</b>					
(budget authority in millions of dollars; not adjusted for inflation)					
Fiscal Year	2014*	2015*	2016*	2017*	2018**
DOD	66,018	65,547	71,421	49,197	43,616
NASA	11,906	12,145	13,253	10,704	10,243
DOE	11,996	14,354	15,217	14,896	15,006
HHS	30,685	30,453	32,243	34,222	33,772
NSF	5,827	5,944	6,010	5,938	6,030
USDA	2,380	2,452	2,657	2,585	2,487
Interior	840	863	973	953	964
DOT	853	885	927	904	929
EPA	539	523	516	497	496
DOC	1,556	1,524	1,681	1,794	1,833
DHS	1,032	919	582	724	672
VA	1,101	1,178	1,222	1,346	1,338
Other	1,602	1,491	1,600	1,529	1,615
<b>Total R&amp;D</b>	<b>136,335</b>	<b>138,278</b>	<b>148,302</b>	<b>125,289</b>	<b>119,001</b>
<i>"Old method"</i>	--	--	--	<i>154,983</i>	<i>153,932</i>

Source: \* Congressional Research Service, Federal Research and Development Funding series, Table I  
 \*\* 2018 Annualized CR from White House OMB FY 2018 Budget

Note: Definition of development was changed to meet international standards, which affects reporting of 2017 and subsequent fiscal years.

# UH Mānoa '14 – '18

Campus Details	2014 Amount	2015 Amount	2016 Amount	2017 Amount	2018 Amount	'14 vs. '18
Chancellor, UH Manoa	250,000	-	-	-	30,000	-88.00%
College of Arts and Humanities	586,019	512,572	502,487	614,377	386,335	-34.07%
College of Education	18,343,323	19,888,925	19,943,721	16,177,466	13,415,976	-26.86%
College of Engineering	4,476,386	3,312,378	7,142,117	4,680,411	3,942,763	-11.92%
College of Language, Linguistics and Literature	2,143,631	1,897,049	3,378,932	2,243,734	2,640,397	23.17%
College of Natural Sciences	28,090,465	35,093,941	33,558,922	32,794,485	32,165,964	14.51%
College of Social Sciences	13,384,646	16,507,535	14,075,445	11,544,031	13,811,775	3.19%
College of Tropical Agriculture and Human Resources	20,274,254	18,206,003	16,142,548	13,619,801	17,648,266	-12.95%
Colleges of Arts and Sciences	-	-	-	-	18,000	N/A
Hawai'inuiakea School of Hawaiian Knowledge	656,223	1,299,124	3,679,757	1,996,314	2,555,214	289.38%
Institute for Astronomy	24,260,599	22,227,055	20,520,303	18,339,284	15,670,948	-35.41%
John A. Burns School of Medicine	50,178,140	52,540,365	54,629,071	61,527,128	59,950,931	19.48%
Lyon Arboretum	170,000	381,413	1,276,866	752,957	478,823	181.66%
Office of Research Compliance	-	-	-	-	49,900	N/A
Outreach College	68,670	788,766	55,761	165,214	149,263	117.36%
School of Architecture	155,796	139,938	139,696	163,646	150,175	-3.61%
School of Nursing and Dental Hygiene	1,337,314	2,531,252	1,746,083	1,223,898	2,407,654	80.04%
School of Ocean and Earth Science and Technology	106,880,076	92,747,632	87,128,306	79,154,444	93,144,266	-12.85%
School of Pacific and Asian Studies	550,146	1,923,940	3,598,934	934,209	2,011,240	265.58%
School of Social Work	3,910,406	4,479,288	4,907,971	5,923,941	7,024,273	79.63%
Shidler College of Business	363,328	930,642	(208,957)	269,596	-	-100.00%
University of Hawaii Cancer Center	19,710,776	24,244,005	25,874,191	29,999,976	20,857,092	5.82%
Vice Chancellor, Academic Affairs	1,181,896	1,258,963	1,612,550	1,463,442	1,408,738	19.19%
Vice Chancellor, Admin, Finance and Operations	2,005,868	117,037	1,581,514	4,807	-	-100.00%
Vice Chancellor, Research	-	-	-	-	24,953	N/A
Vice Chancellor, Students	4,457,202	3,264,090	4,005,474	6,778,650	4,622,694	3.71%
Waikiki Aquarium	-	105,019	37,699	-	-	N/A
Water Resources Research Center	144,061	481,073	735,955	1,458,277	3,989,558	2669.35%
William S. Richardson School of Law	1,931,579	1,532,618	2,737,026	2,176,471	2,540,068	31.50%
<b>Grand Total</b>	<b>305,510,804</b>	<b>306,410,623</b>	<b>308,802,372</b>	<b>294,006,559</b>	<b>301,095,266</b>	<b>-1.45%</b>



# UH Hilo & UH West Oahu '14 – '18

UH Hilo Campus Details	2014 Amount	2015 Amount	2016 Amount	2017 Amount	2018 Amount	'14 vs. '18
Athletics (UH Hilo)	-	10,000	-	-		N/A
Chancellor, UH Hilo	4,486,703	5,953,976	1,144,232	1,436,257	1,958,215	-56.36%
College of Agriculture, Forestry and Natural Resource Mgt	898,884	880,810	1,674,869	1,409,810	1,077,332	19.85%
College of Arts and Sciences	4,076,094	3,801,888	3,864,553	4,215,798	2,928,225	-28.16%
College of Business and Economics	-	24,970	-	-	120,000	N/A
College of Continuing Education and Community Svc	7,500	736,100	35,039	99,931	31,750	323.33%
College of Pharmacy	6,584,351	6,255,453	629,526	667,726	196,873	-97.01%
Hawaii Small Business Development Center	816,250	1,093,089	775,150	909,979	1,142,235	39.94%
Imiloa Astronomy Center Of Hawaii	486,520	267,347	378,393	505,336	832,854	71.19%
Ka Haka'Ula O Ke'Elikelani-UHH	279,698	283,900	557,887	860,980	1,774,041	534.27%
Vice Chancellor for Academic Affairs (UH Hilo)	-	87,873	-	-	57,000	N/A
Vice Chancellor for Administrative Affairs	-	2,125	3,925		2,250	N/A
Vice Chancellor for Research	1,594,780	1,846,139	1,606,691	874,009	1,482,154	-7.06%
Vice Chancellor for Student Affairs	3,334,475	2,644,572	1,999,490	1,901,860	1,347,664	-59.58%
<b>Grand Total</b>	<b>22,565,255</b>	<b>23,888,242</b>	<b>12,669,755</b>	<b>12,881,686</b>	<b>12,950,593</b>	<b>-42.61%</b>
Campus	2014 Amount	2015 Amount	2016 Amount	2017 Amount	2018 Amount	'14 vs. '18
UH West Oahu	1,844,171	3,686,265	5,326,027	5,631,172	6,035,273	227.26%



# UH Community Colleges '14 – '18

Campus	2014 Amount	2015 Amount	2016 Amount	2017 Amount	2018 Amount	'14 vs. '18
Hawai'i Community College	294,477	2,321,010	68,000	179,897	557,101	89.18%
Honolulu Community College	757,953	1,779,497	2,639,133	2,864,032	1,679,521	121.59%
Kapi'olani Community College	6,070,759	5,174,282	4,100,121	6,736,316	5,211,039	-14.16%
Kaua'i Community College	1,021,526	1,754,417	1,004,692	2,007,725	876,089	-14.24%
Leeward Community College	1,195,087	3,930,191	3,455,755	4,260,373	3,064,574	156.43%
University of Hawai'i Maui College	8,860,909	18,650,061	10,510,676	7,440,725	11,925,050	34.58%
Windward Community College	2,161,043	6,235,610	5,313,299	7,406,077	7,324,832	238.95%
<b>Grand Total</b>	<b>20,361,754</b>	<b>39,845,068</b>	<b>27,091,676</b>	<b>30,895,145</b>	<b>30,638,206</b>	<b>50.47%</b>



# UH System '14 – '18

Campus Details	2014 Amount	2015 Amount	2016 Amount	2017 Amount	2018 Amount	'14 vs. '18
Office of the Vice President for Community Colleges	815,102	5,840,365	1,021,329	1,329,109	1,409,610	72.94%
Office of the Vice President for Research and Innovation	9,540,902	14,273,064	417,387	8,817,197	8,149,281	-14.59%
Office of the VP for Academic Planning and Policy	6,436,102	5,698,792	10,345,760	10,151,665	4,609,372	-28.38%
Office of the VP for Information Tech/Chief Info Officer	24,707,730	25,977,669	25,660,222	23,252,872	21,414,102	-13.33%
Office of the VP for Student Affairs and Univ/Comm Relations	50,000	-	-	-	-	-100.00%
VP For Administration	-	-	-	36,300	10,000	N/A
<b>Grand Total</b>	<b>41,549,836</b>	<b>51,789,890</b>	<b>37,444,698</b>	<b>43,587,143</b>	<b>35,592,365</b>	<b>-14.34%</b>



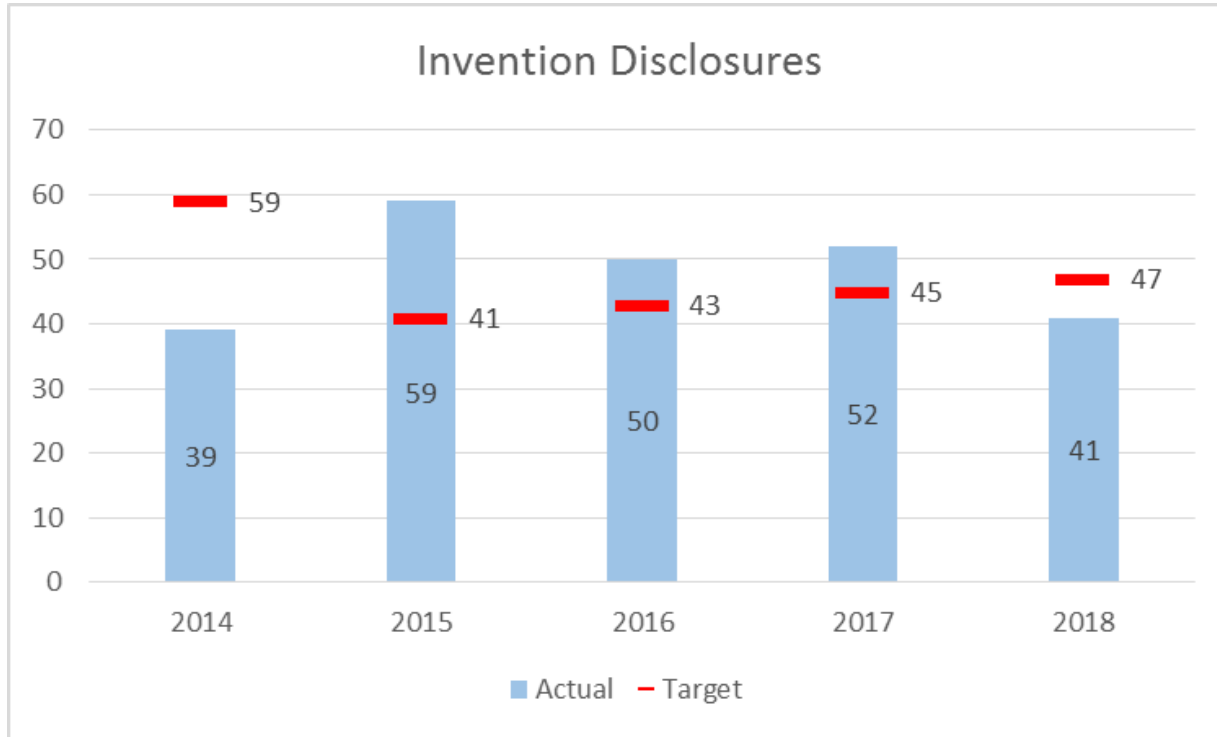

	FY 2016		FY 2017		FY 2018	
	Target	Actual	Target	Actual	Target	Actual
Invention Disclosures	43	50	45	52	47	41



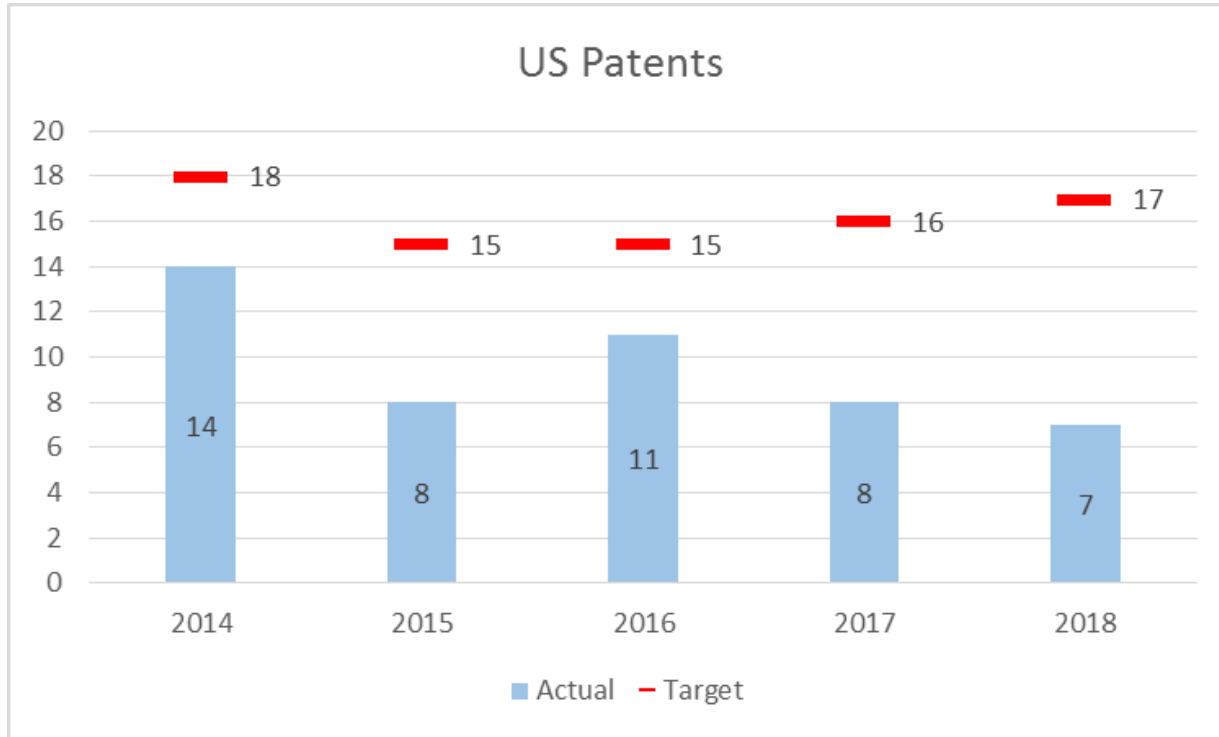

	FY 2016		FY 2017		FY 2018	
	Target	Actual	Target	Actual	Target	Actual
US Patents	15	11	16	8	17	7



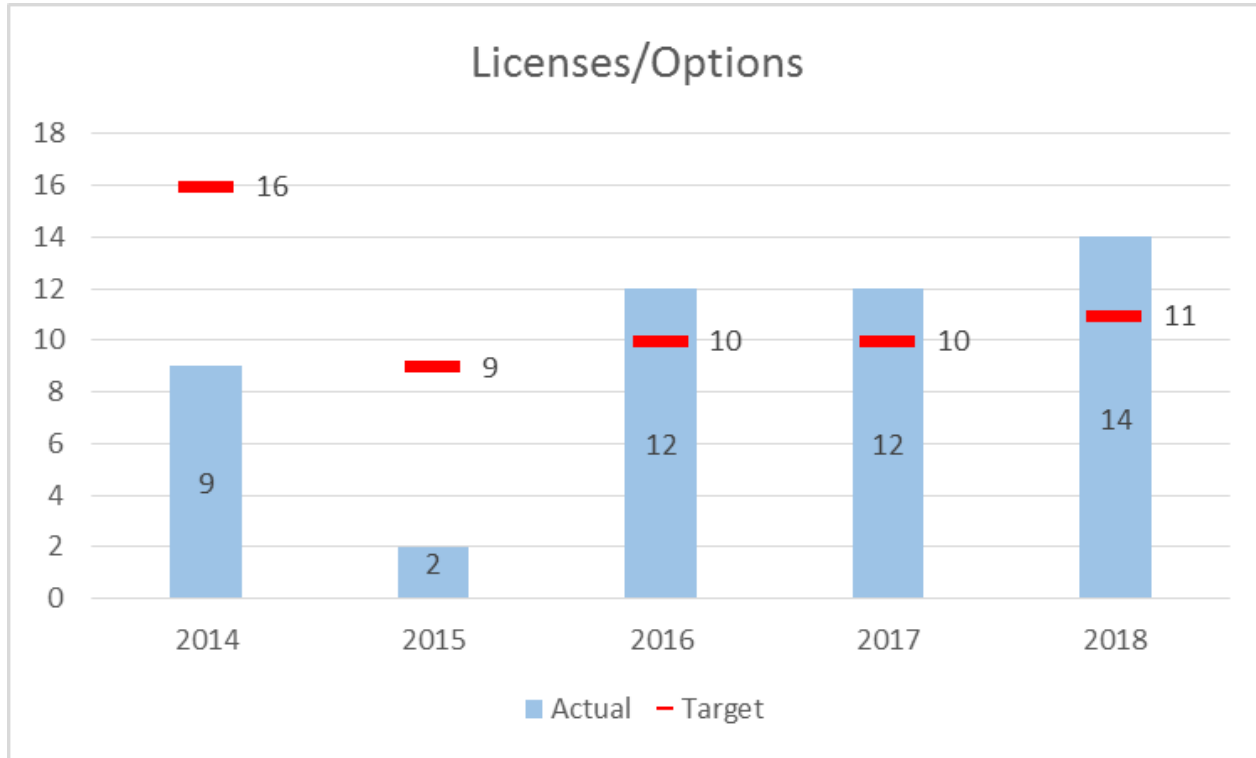

	FY 2016		FY 2017		FY 2018	
	Target	Actual	Target	Actual	Target	Actual
Licenses/Options	10	12	10	12	11	14



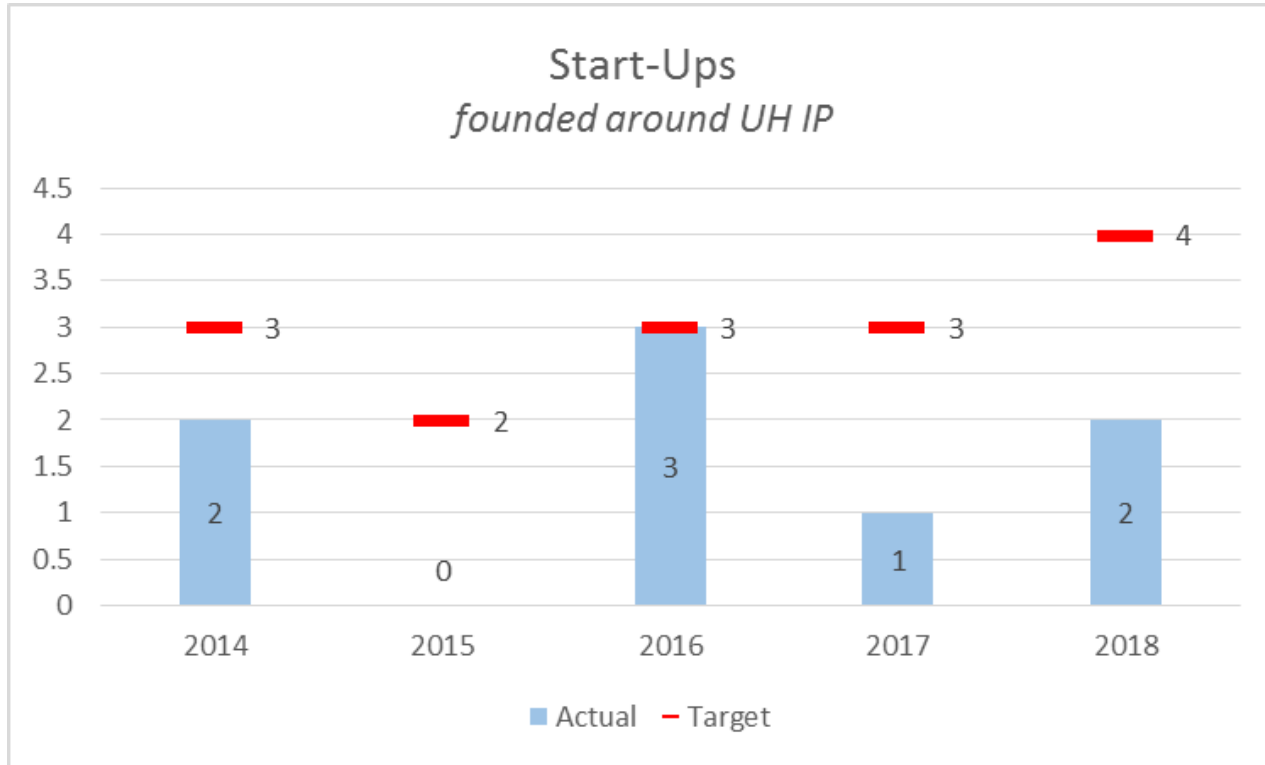

	FY 2016		FY 2017		FY 2018	
	Target	Actual	Target	Actual	Target	Actual
Start-Up Companies	3	3	3	1	4	2



# FY 19 Projection

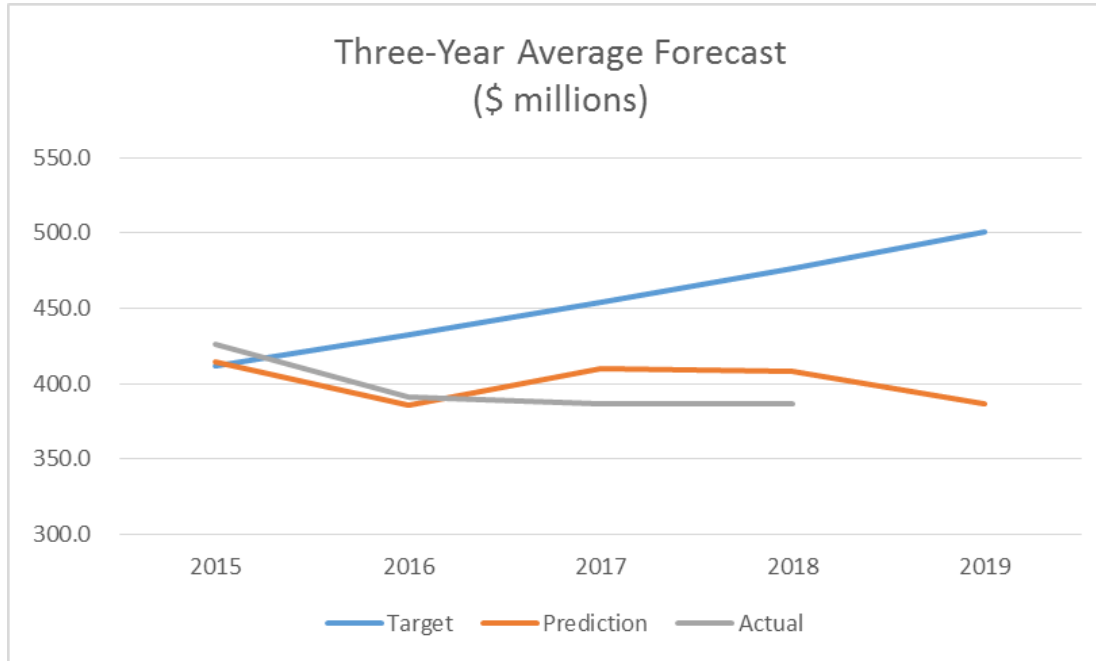

FY	Target	Prediction	Actual
2015	411.9	414.5	425.7
2016	432.5	385.9	391.3
2017	454.2	410.0	387.0
2018	476.7	408.0	386.3
2019	500.8	386.7	TBD

FY 19 extramural awards predicted to be \$386.7 million.  
UH Strategic Directions target is \$500.8 million (stretch goal).



# Appendix

---

- Other R&I metrics
  - Extramural Expenditures
  - F&A Recovery
  - Active Licenses/Options
  - Royalties

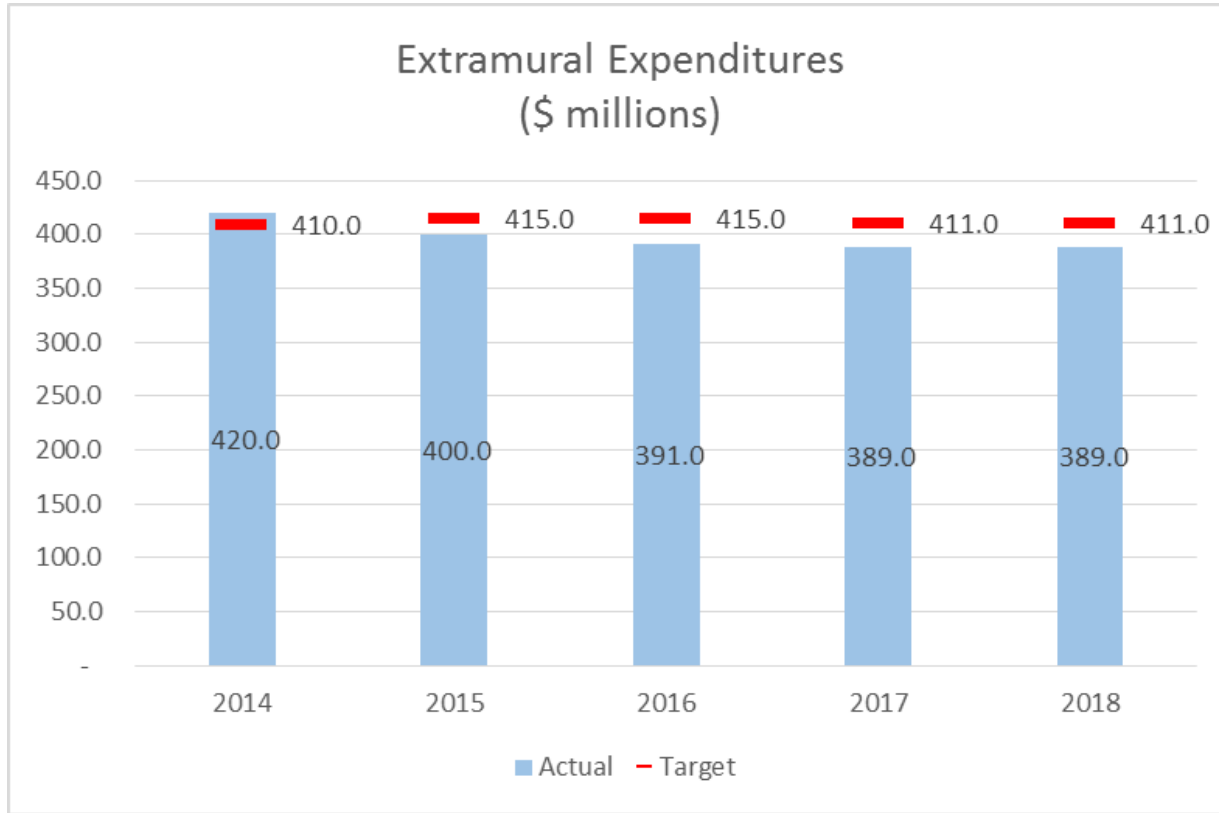

	FY 2016		FY 2017		FY 2018	
	Target	Actual	Target	Actual	Target	Actual
Extramural Expenditures (\$ m)	415	391	411	389	411	389



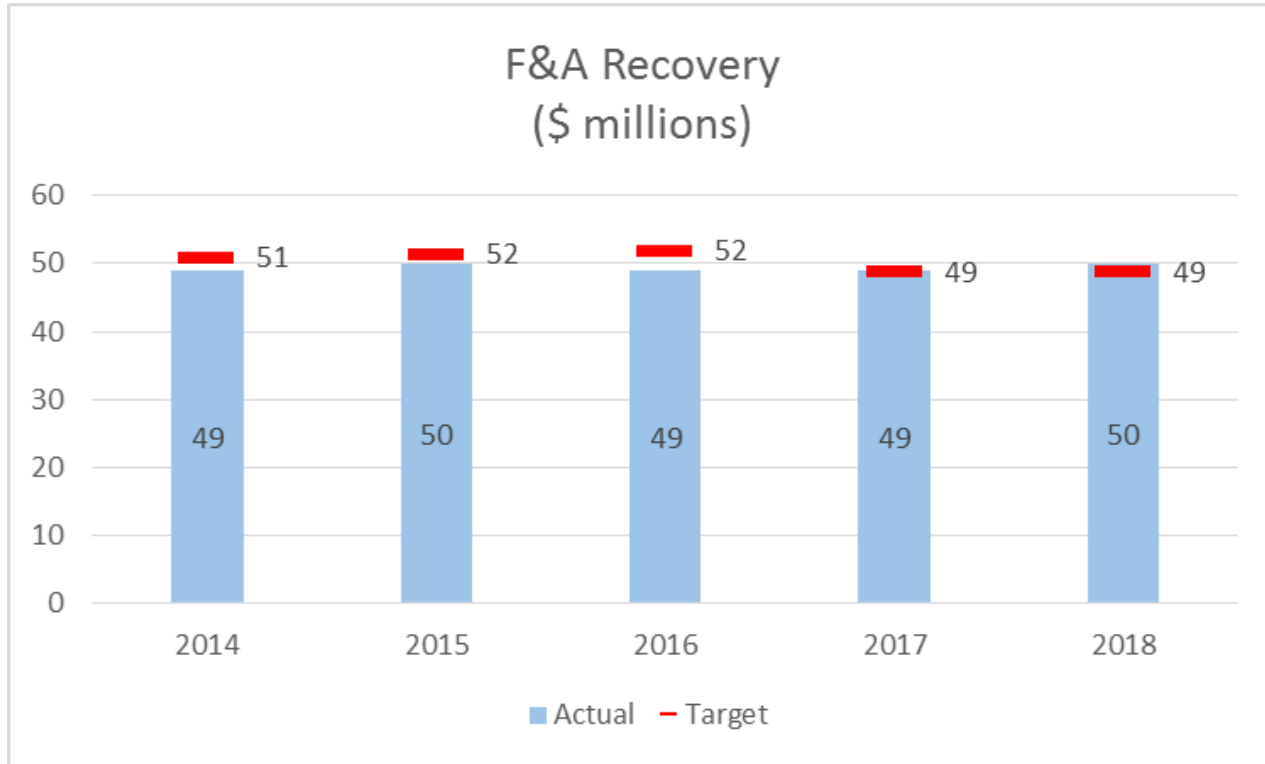

	FY 2016		FY 2017		FY 2018	
	Target	Actual	Target	Actual	Target	Actual
F&A Recovery (\$ millions)	52	49	49	49	49	50



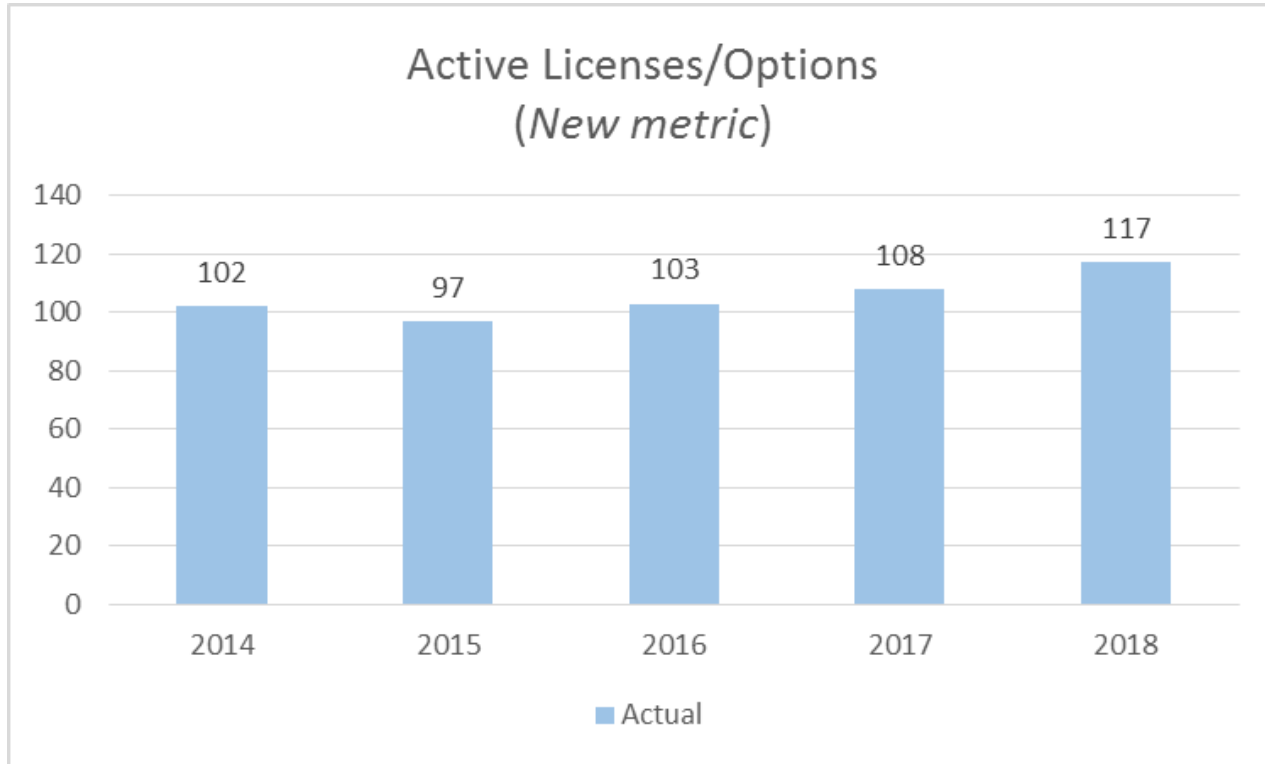

### Start-Ups and New Companies *founded around UH IP or formed by UH faculty, staff or students* (New metric)

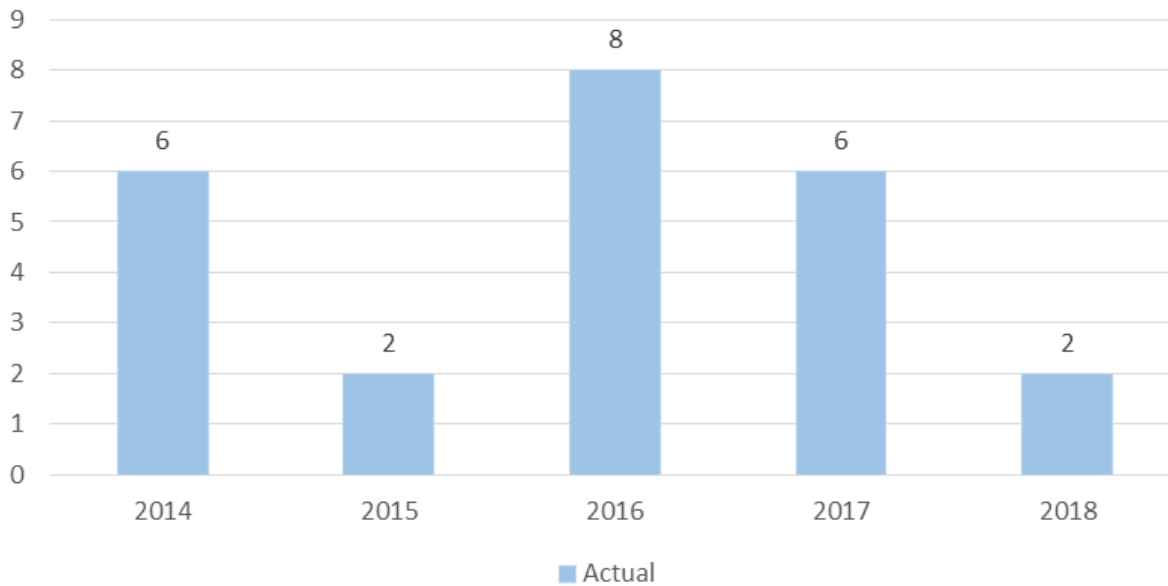

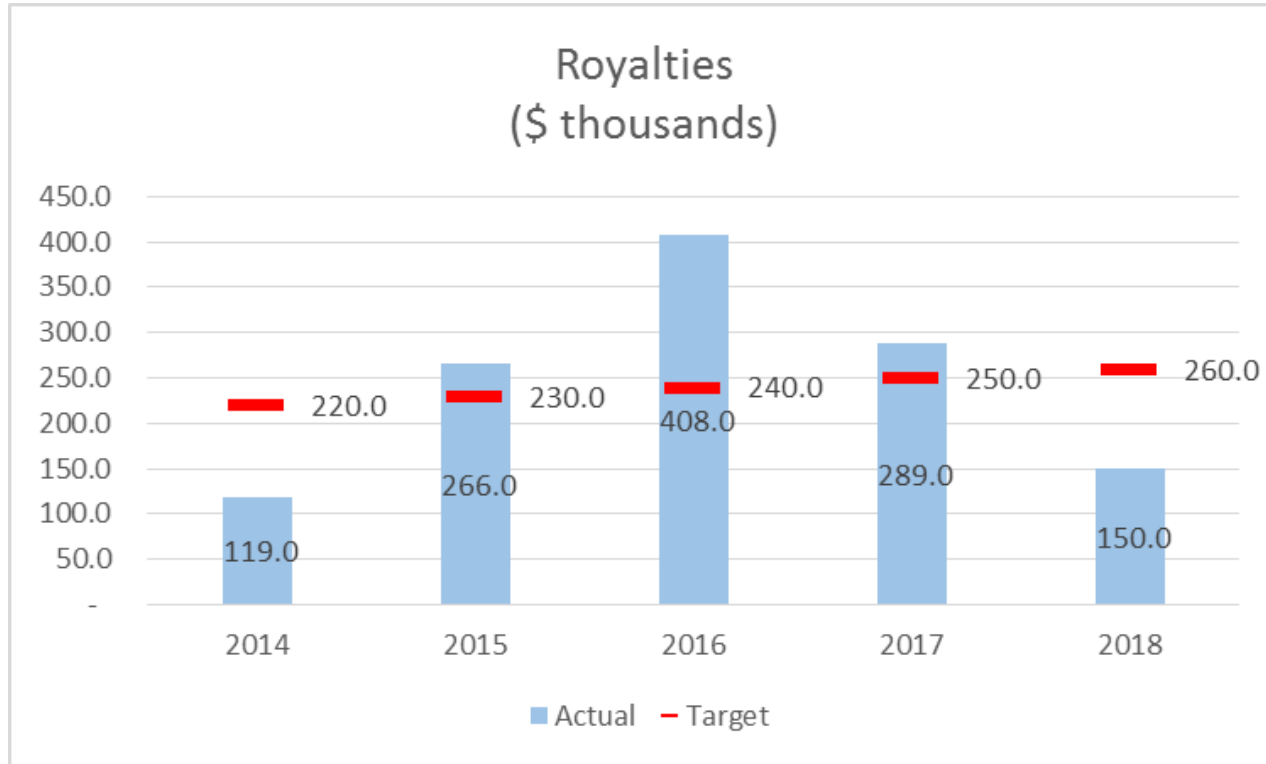

	FY 2016		FY 2017		FY 2018	
	Target	Actual	Target	Actual	Target	Actual
Royalties (\$ thousands)	240	🟢 408	250	🟢 289	260	🟡 150



## FY18 Q4 Extramural Awards Analysis Report

### Summary

The University of Hawai'i's (UH) extramural awards for the fourth quarter of FY 2018 totaled \$88.8 million, which is about 12.9% more than the amount received during Q4 of last year. While FY18 fiscal year results were \$386.3 million (or about 0.2%) less than FY 17, stable results are assuring given the current funding environment.

### I. Quarterly Performance Metrics

Extramural awards for FY 18 Q4 totaled \$88.8 million, which is 12.9% more than the FY17 Q4 total. See *III. Award Trends by Campus* for an explanation of major increases or decreases that contributed to the FY18 Q4 results.

Quarterly Extramural Awards								
\$ millions								
	2011	2012	2013	2014	2015	2016	2017	2018
Q1	251.5	203.2	178.1	166.5	191.1	165.8	181.8	164.5
Q2	78.8	47.5	74.8	74.7	77.0	56.9	59.5	62.0
Q3	68.8	45.3	56.7	55.4	52.8	66.2	67.1	71.0
Q4	89.5	139.9	100.1	95.7	104.8	102.4	78.6	88.8
<b>FY</b>	<b>488.6</b>	<b>435.9</b>	<b>409.8</b>	<b>392.3</b>	<b>425.7</b>	<b>391.3</b>	<b>387.0</b>	<b>386.3</b>

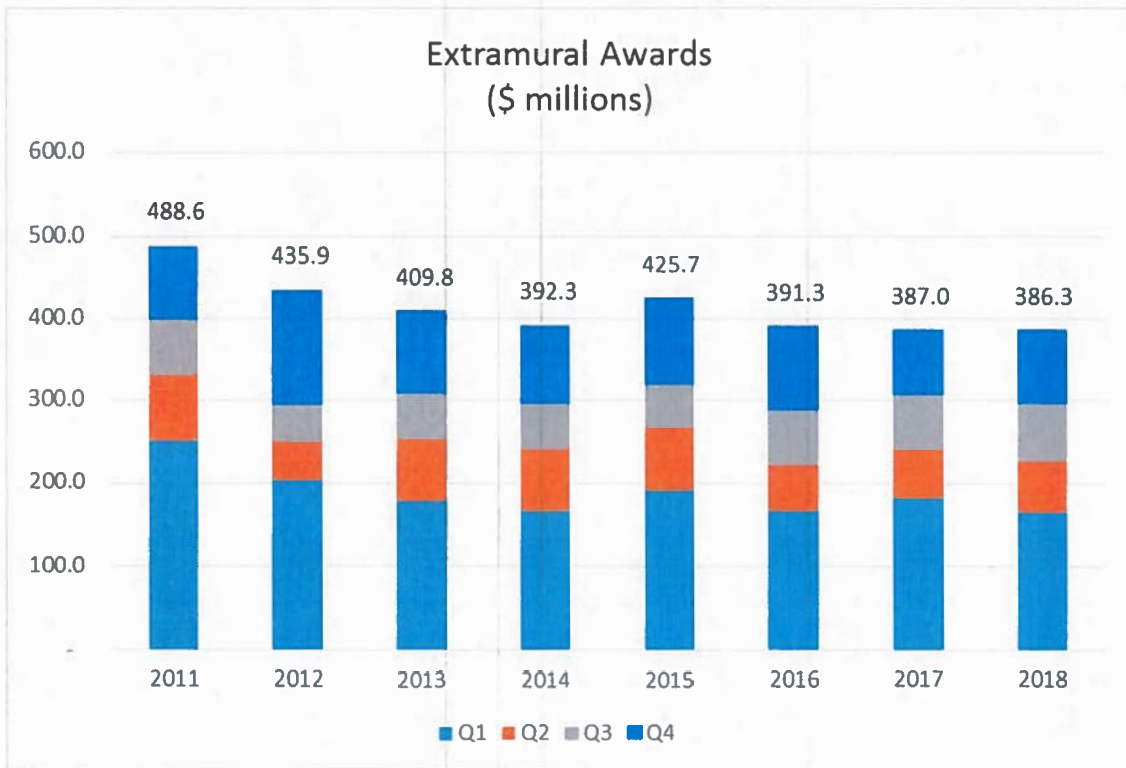

## II. Significant Awards by Campus

During FY18 Q4, UH received 469 awards from 191 different sponsors. The following table reports the largest awards received this quarter by campus.

Campus	Sponsor Type	Sponsor	Project Title	Amount
Mānoa	Federal	Department of Health & Human Services	Ola HAWAII	4,414,052
Hilo	Federal	Department of Health & Human Services	Students of Hawaii Advanced Research Program (SHARP)	431,344
West O'ahu	Federal	National Science Foundation	Dynamics of the Mokauea Fishpond	116,381
Hawai'i CC	N/A	N/A	N/A	18,000
Honolulu CC	Federal	National Science Foundation	Development of a Data Analytics Education Pathway	221,951
Kapi'olani CC	Federal	National Science Foundation	Bridge to the Baccalaureate: Strategic Transfer Alliance for Minority Participation (STAMP)	494,100
Kaua'i CC	N/A	N/A	N/A	N/A
Leeward CC	Hawai'i – Gov't	Department of Human Services	Provide Vocational Skills Training For First-To-Work Participants Attending Leeward Community College	212,488
Maui College	Hawai'i – Gov't	County of Maui	WIOA Service Provider for Year-Round Youth Services	112,000
Windward CC	Non-profit	UH Foundation	Hiilei Early College Initiative	97,032
UH System <sup>1</sup>	Federal	Department of Defense	University of Hawaii Pacific Disaster Center (UoH PDC) Cooperative Agreement	5,227,895

## III. Award Trends by Campus

Award totals for the fourth quarter of FY 2018 were more than it was the same time last year by about 12.9%. Major dollar increases and decreases are attributed as follows:

UH Hilo decrease: In FY17 Q4, UH Hilo received incremental funding from the National Science Foundation in the amount of of \$1 million. No comparable sized awards were received in FY18 Q4.

UH Maui College decrease: In FY17 Q4, there were two US Department of Education Upward Bound awards totaling \$647,354, and a Maui County Community Television award for \$161,041. Except for the County of Maui award for \$112,000, no comparable sized awards were received in FY18 Q4.

<sup>1</sup> UH System represents units under Vice Presidents that receive extramural funding. Examples include the P20 and Gear Up grants under the VP for Academic Affairs; Maui High Performance Computing Center and Pacific Disaster Center contracts under the VP for Information Technology; EpSCOR grant and Applied Research Laboratory task orders under the VP for Research and Innovation; and the Pacific Business Center Program under the VP for Community Colleges.



UH System increase: The increase is attributed to the \$5,227,895 Department of Defense award received.

UH Mānoa increase: Approximately 10 units accounted for the overall net increase.

Unit	Change
Coll. of Education	-3.7m
Coll. of Language, Linguistics and Literature	0.8m
Coll. of Natural Sciences	2.3m
Coll. of Social Sciences	-0.6m
Coll. of Tropical Agriculture & Human Resources	0.7m
Institute for Astronomy	-2.7m
John A Burns School of Medicine	3.5m
Sch. of Ocean, Earth Science & Technology	7.8m
University of Hawaii Cancer Center	2.1m
Vice Chancellor, Students	-0.5m
<b>TOTAL</b>	<b>9.7m</b>

**Q4 Award Amounts by Location**  
\$ millions

Campus	2015	2016	2017	2018	2018-17 Change <sup>2</sup>
Mānoa	80.1	80.0	64.8	74.5	15.0%
Hilo	5.8	3.3	4.1	2.9	-29.5%
West O'ahu	0.3	0.1	0.1	0.3	167.3%
Hawai'i CC	0.5	0.0	0.0	0.0	-100.0%
Honolulu CC	0.0	0.1	0.3	0.3	22.1%
Kapi'olani CC	0.8	0.4	0.7	1.0	36.8%
Kaua'i CC	0.4	0.0	0.0	0.0	0.0%
Leeward CC	0.2	0.3	0.1	0.2	83.8%
Maui College	0.4	2.3	0.9	0.2	-81.7%
Windward CC	1.0	0.1	0.0	0.1	1525.7%
UH System	15.3	15.8	7.6	9.3	22.4%
TOTAL	104.8	102.4	78.6	88.8	12.9%

**IV. Analysis**

*Q4/Fiscal Year (FY) Results*

UH Mānoa's Q4 performance helped improve overall FY18 Q4 results compared to FY17 Q4, but not compared against FY14 and F 15's Q4 results.

FY18 fiscal year results were about 0.2% less than FY 17. With the exception of FY15, it looks like UH is on a plateau. However, UH Mānoa is showing upward movement, which we expect to accelerate in FY19 and thus improve the overall extramural awards landscape.

<sup>2</sup> The percent change over the prior fiscal year is calculated using the actual figures not the rounded figures.

In the FY17 Q4 report, we noted the performance of five UH Mānoa colleges/research units. The following tables summarize the FY14 – FY18 results.

*Decreasing trend reported in FY17*

College/Research Unit	2014	2015	2016	2017	2018
College of Tropical Agriculture and Human Resources	20,274,254	18,206,003	16,142,548	13,619,801	17,648,266
Institute for Astronomy	24,260,599	22,227,055	20,520,303	18,339,284	15,670,948
School of Ocean and Earth Science and Technology	106,880,076	92,747,632	87,128,306	79,154,444	93,144,266

*Increasing trend reported in FY17*

College/Research Unit	2014	2015	2016	2017	2018
John A. Burns School of Medicine	50,178,140	52,540,365	54,629,071	61,527,128	59,950,931
University of Hawaii Cancer Center	19,710,776	24,244,005	25,874,191	29,999,976	20,857,092

*Additional Colleges/Research Units for Discussion*

College/Research Unit	2014	2015	2016	2017	2018
College of Education	18,343,323	19,888,925	19,943,721	16,177,466	13,415,976
College of Social Sciences	13,384,646	16,507,535	14,075,445	11,544,031	13,811,775
College of Engineering	4,476,386	3,312,378	7,142,117	4,680,411	3,942,763
College of Natural Sciences	28,090,465	35,093,941	33,558,922	32,794,485	32,165,964

In FY18, increases in the College of Tropical Agriculture and Human Resources (CTAHR) and the School of Ocean and Earth Science and Technology (SOEST) helped to offset decreases in the John A. Burns School of Medicine (JABSOM) and the UH Cancer Center. UH Cancer Center results may have been affected by the timing of the Center's grant renewal, which will be reported in FY19.

Other units such as the College of Social Sciences and College of Natural Sciences contributed to the stable performance over this period.

The new normal is to expect overall stability with an upward growth. The university currently invests in new strategic hiring initiatives within several campuses. UH Mānoa has returned to financial stability, thus strategic hires have commenced in several colleges where we saw a drastic reduction of faculty during the last down turn. These investments have started to pay off, and we expect results to accelerate in the upcoming years.

*Federal R&D Budget and FY19 Outlook*

In our FY17 Q4 report, we noted that federal R&D funding would become available. While that was true for FY16, a change in the definition of development to bring U.S. data in line with international standards made it difficult to determine how much federal R&D funding was actually available in FY17 and FY18.

Total R&D by Agency, FY 2016-2018; FY 2019						
(budget authority in millions of dollars)						
Fiscal Year	2016*	Actual 2016	2017*	Actual 2017	2018 CR**	2019***
DOD	71,453	71,421	71,927	49,197	43,616	57,156
NASA	13,273	13,253	11,956	10,704	10,243	10,651
DOE	14,387	15,217	16,341	14,896	15,006	12,685
HHS	31,917	32,243	30,381	34,222	33,772	24,742
NSF	6,117	6,010	6,052	5,938	6,030	4,177
USDA	2,674	2,657	2,552	2,585	2,487	1,914
Interior	974	973	1,057	953	964	759
DOT	924	927	851	904	929	826
EPA	513	516	503	497	496	269
DOC	1,904	1,681	1,846	1,794	1,833	1,361
DHS	579	582	575	724	672	548
VA	1,220	1,222	1,230	1,346	1,338	1,345
Other	1,585	1,600	1,706	1,529	1,615	1,623
Addendum	0	0	0	0	0	~12,900
<b>Total R&amp;D</b>	<b>147,522</b>	<b>148,302</b>	<b>146,977</b>	<b>125,289</b>	<b>119,001</b>	<b>131,000</b>
			<i>"old method"</i>	<b>154,983</b>	<b>153,932</b>	<b>156,777</b>

Source: Congressional Research Service (LAST UPDATE: April 2018).

\* Estimates reported in FY 17 Q4 report. Source: AAAS R&D report series (LAST UPDATE: June 2016)

\*\* FY 2018 CR is based on White House 2018 Annualized CR.

\*\*\* FY 2019 is the President's request.

FY19 data is the President's request and includes an approximate \$12.9 billion addendum. There are estimates for what the numbers would be under the old method, but it doesn't appear that analysts have checked those estimates. Thus, the numbers under the new method have been used in reports.

Maintaining stable results in FY19 is a good outcome given the uncertainty on the actual amount of the available R&D budget.

## V. Forecast vs. Actuals

### FY 2018 Forecast vs. Actuals

FY18 Q4 actuals (\$88.8 million) were 13.3% less than forecast (\$102.4 million). FY18 actuals (\$386.3 million) were 5.4% short of forecast (\$408.5 million) and 18.9% short of target (\$476.7 million).

FY 2018	Forecast	Actual	Variance
Q1	175.1	164.5	-6.1%
Q2	73.9	62.0	-16.1%
Q3	57.1	71.0	+24.3%
Q4	102.4	88.8	-13.3%
Total	408.5	386.3	-5.4%

**FY 2019 Forecast**

FY18 proposals were around \$1.05 billion, which is the same as FY17. Based on our revised forecasting model, the FY19 forecast is \$386.7 million. The stretch goal for FY19 is \$500.8 million.

FY	Target	Prediction	Actual
2015	411.9	414.5	425.7
2016	432.5	385.9	391.3
2017	454.2	410.2	387.0
2018	476.7	408.5	386.3
2019	500.8	386.7	TBD

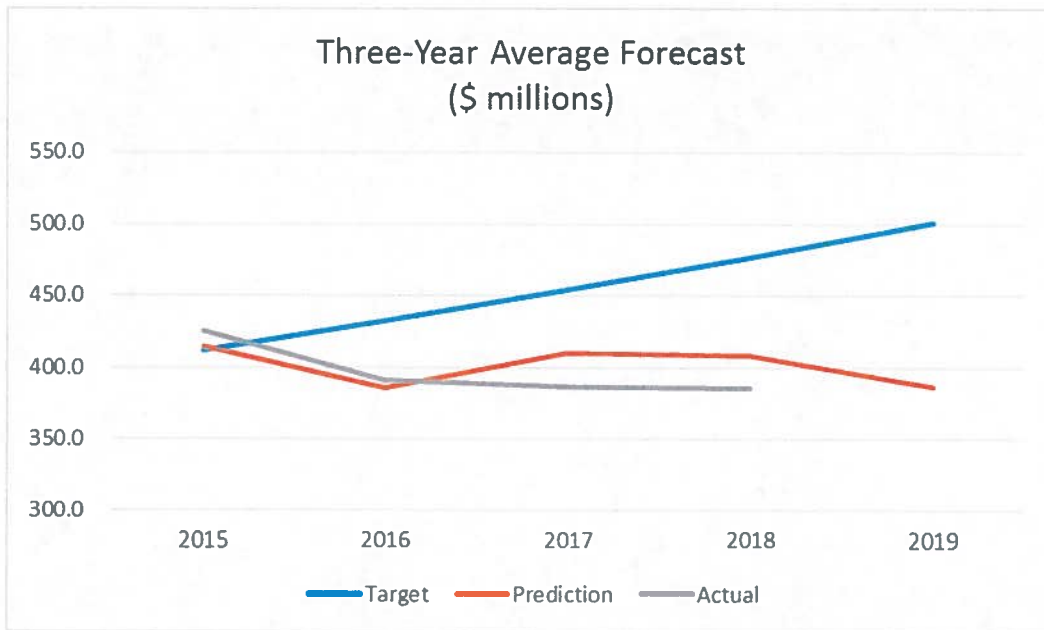

## Extramural Sponsor Awards Quarterly Summary

<u>Program Type</u>	<b>Apr 1 - Jun 30 2018</b>		<b>Apr 1 - Jun 30 2017</b>	
	<u>Count</u>	<u>Amount</u>	<u>Count</u>	<u>Amount</u>
Research	263	\$ 53,663,099	232	\$ 43,064,427
Non-Research	206	\$ 34,906,004	216	\$ 38,441,576
<b><u>Total</u></b>	<b><u>469</u></b>	<b><u>\$ 88,569,043</u></b>	<b><u>448</u></b>	<b><u>\$ 81,506,003</u></b>

Note: The detailed award listing is available at:

<http://www.ors.hawaii.edu/index.php/bor-reports>

The FY 2017 year-to-date total was: \$387,001,705

The unofficial FY 2018 year-to-date total is: 1,879 awards totaling \$386,311,703.

Contracts and Grants Awards  
As of Quarter Four – FY 2018

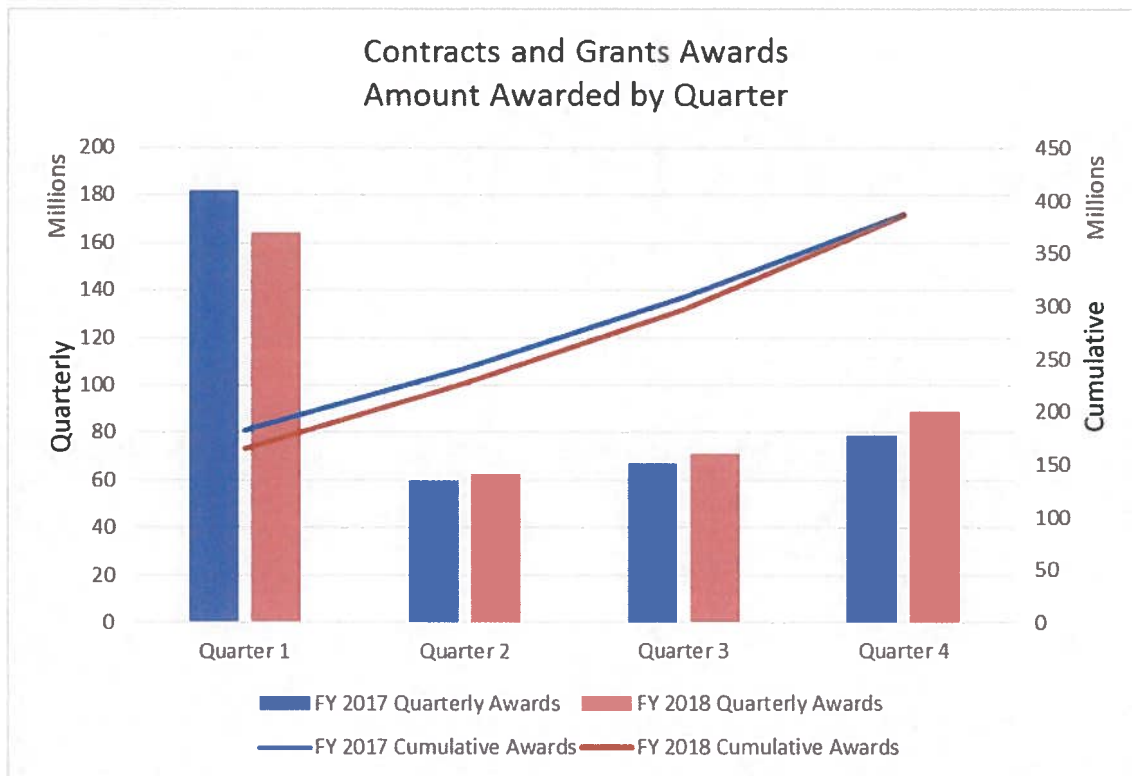

Contracts and Grants Expenditures  
As of Quarter Four – FY 2018

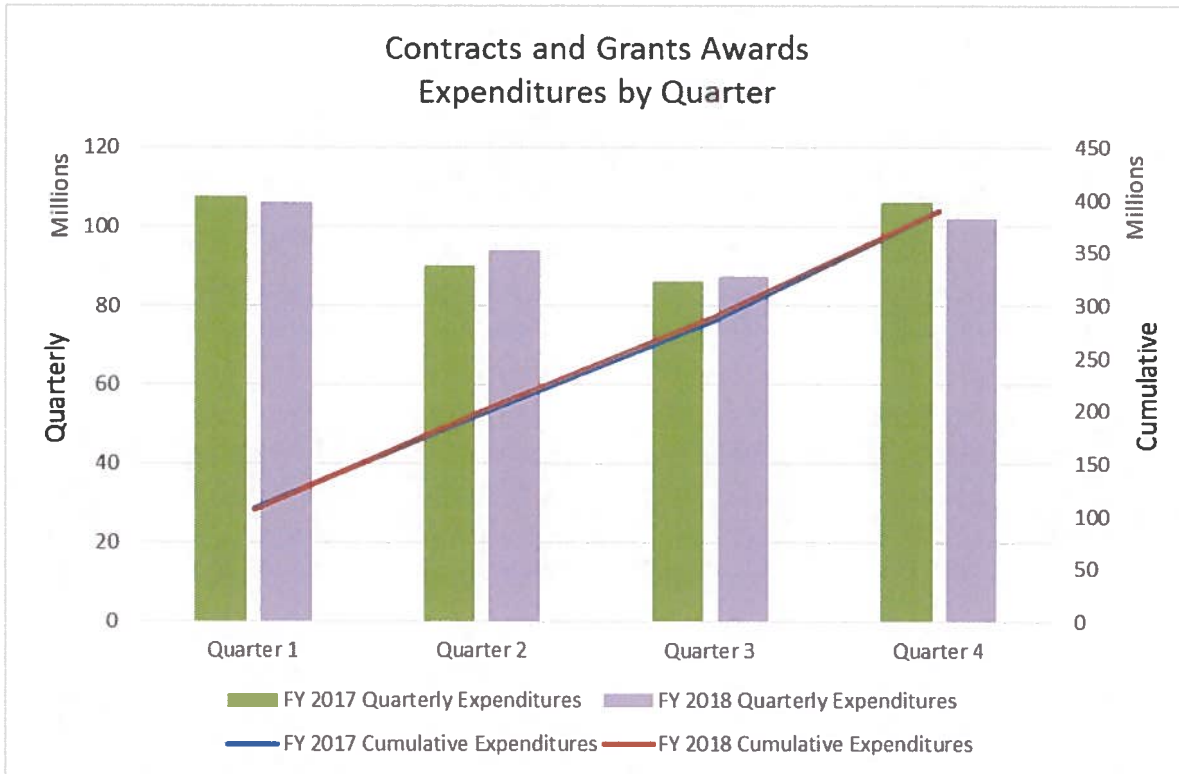

Contracts and Grants F&A Recovery  
As of Quarter Four – FY 2018

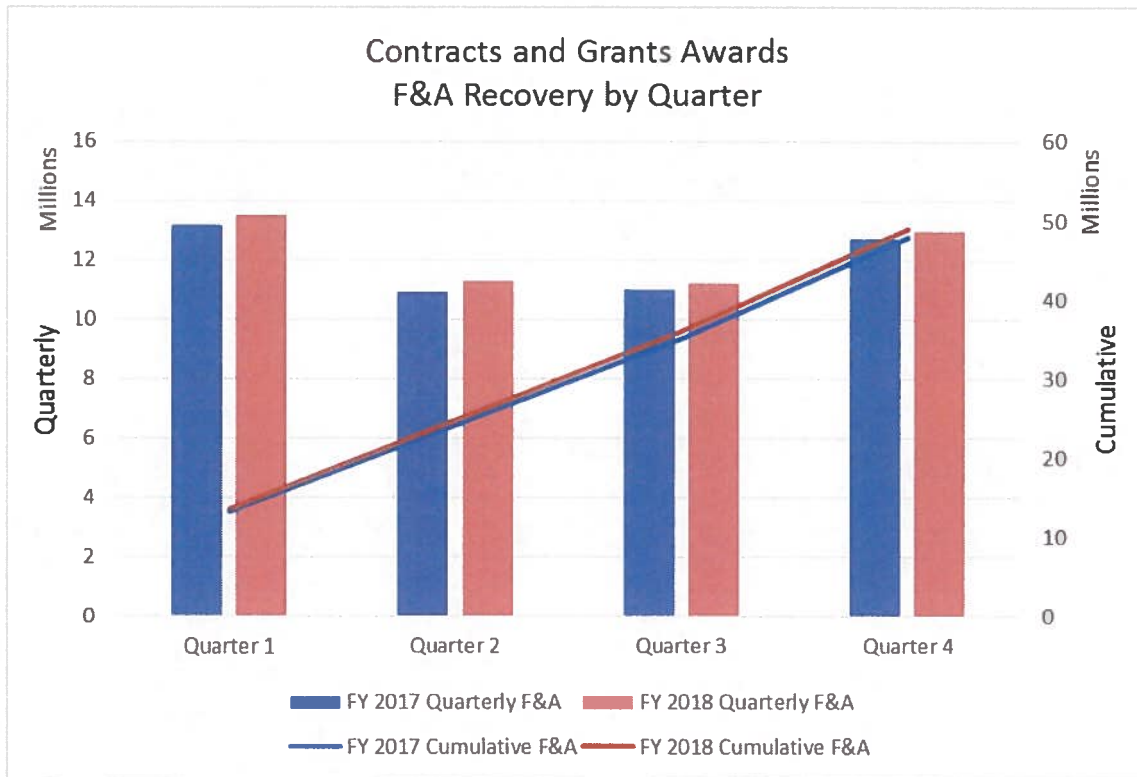



**OTT Research & Innovation Metrics  
FY 2018 – Fourth Quarter Summary**

<u>Metric</u>	FY 2018	FY 2017
	<u>4/1/18 – 6/30/18</u>	<u>4/1/17 – 6/30/17</u>
Invention Disclosures	12	8
U.S. Provisional Patents Filed	8	6
U.S. Non-Provisional Patents Filed	2	0
U.S. Non-Provisional Patents Issued	2	2
License Agreements	4	4
Royalty Revenue	\$19,612.48	\$39,506.54

Invention Disclosures  
As of Quarter 4 – FY 2018

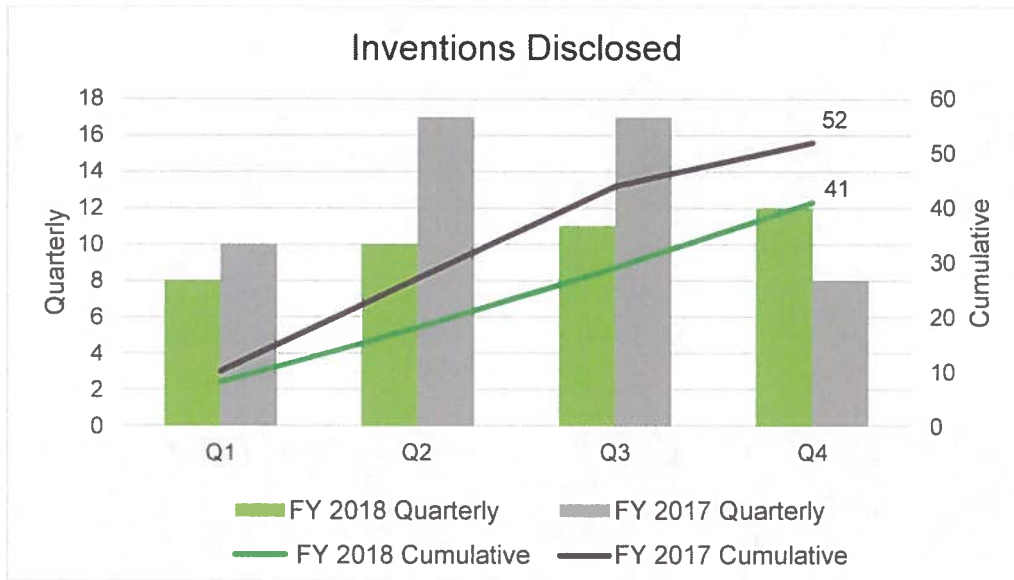

U.S. Provisional Patents Filed  
As of Quarter Four – FY 2018

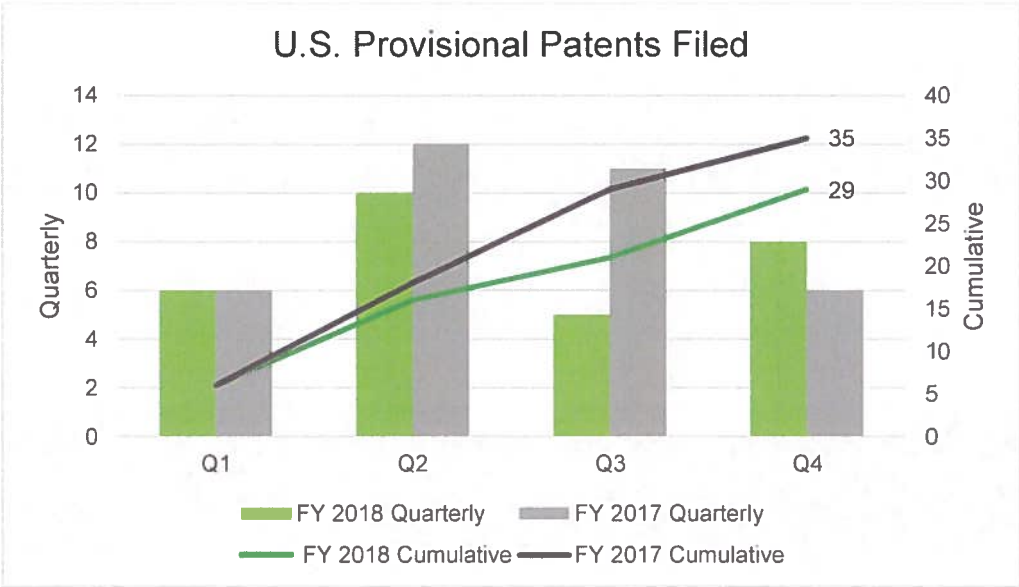

U.S. Non-Provisional Patents Filed  
As of Quarter Four – FY 2018

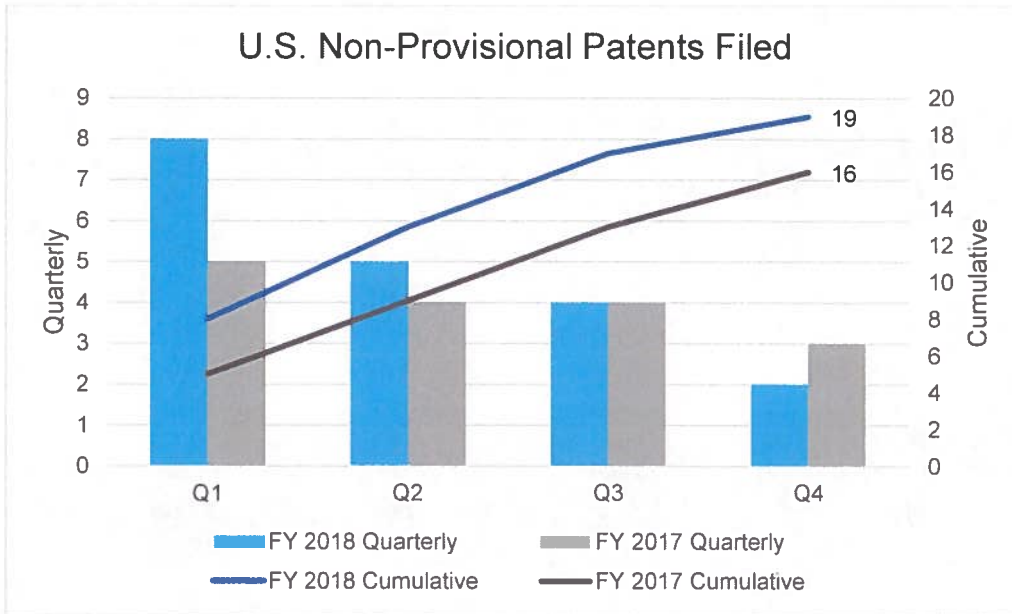

U.S. Non-Provisional Patents Issued  
As of Quarter Four – FY 2018

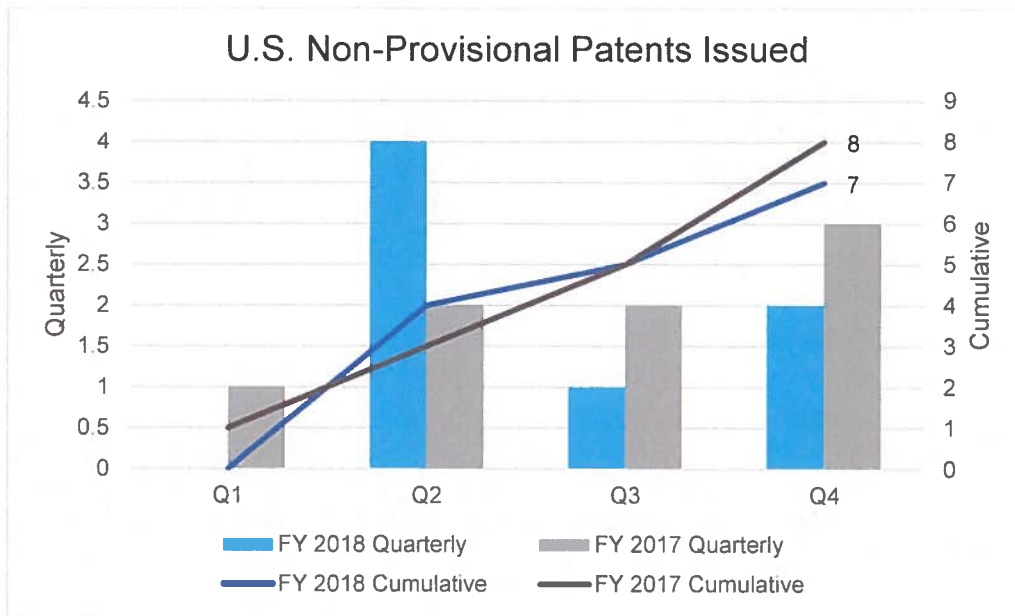

License/Option Agreements  
As of Quarter Four – FY 2018

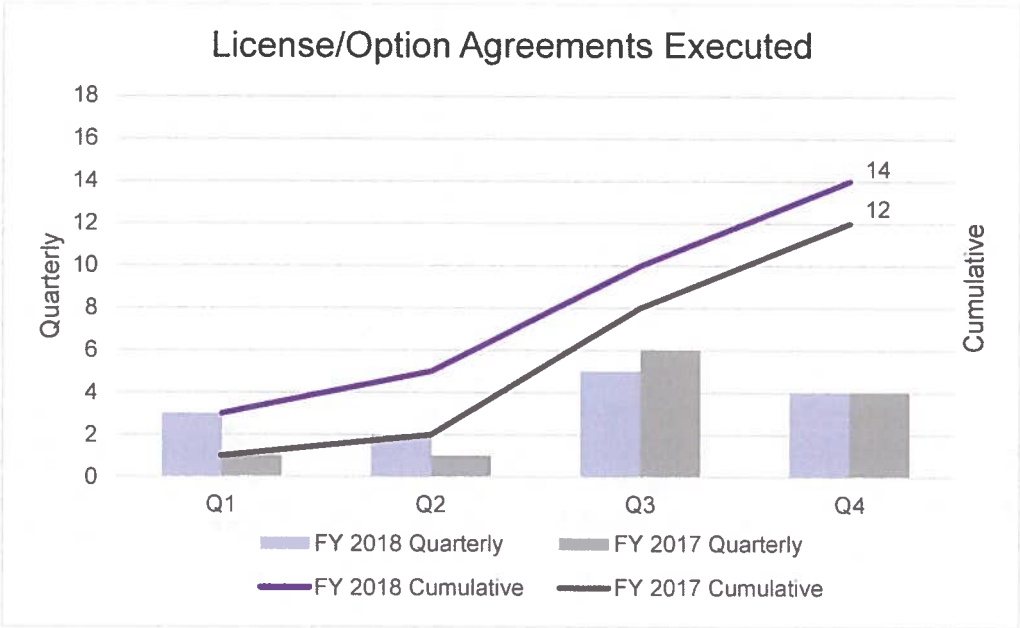

**Royalty Revenue  
As of Quarter Four – FY 2018**

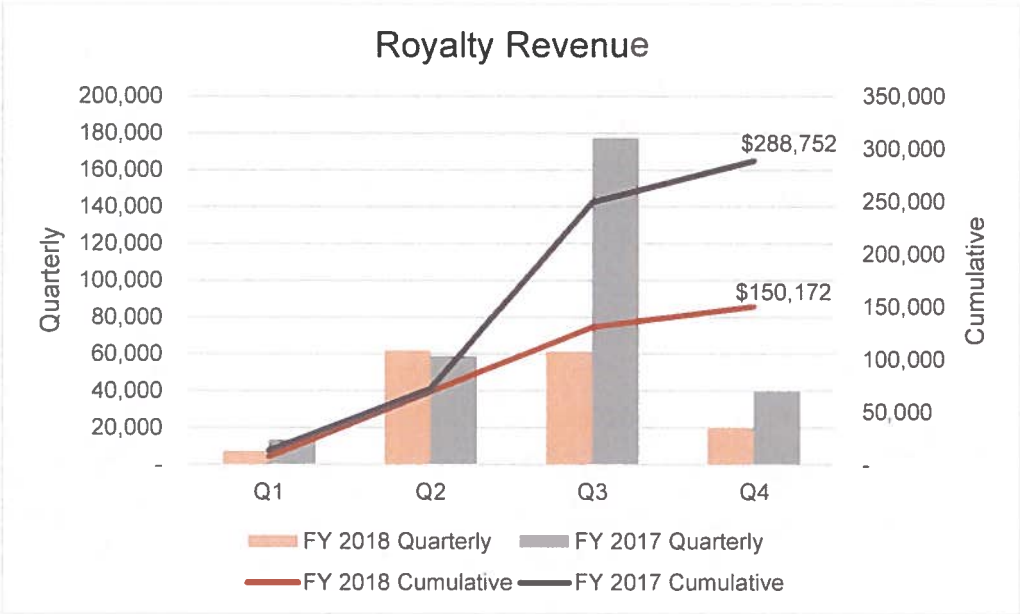

FY 2018 Monthly Report of Awards to Date as of June 30, 2018						
Summary By Campus						
Campus	FY 2017		FY 2018		\$ Change	% Change
	Award Count	Award Amount	Award Count	Award Amount		
Hawai'i Community College	7	179,897	7	557,101	377,204	209.7%
Honolulu Community College	15	2,864,032	13	1,679,521	(1,184,511)	-41.4%
Kapi'olani Community College	22	6,736,316	17	5,211,039	(1,525,277)	-22.6%
Kaua'i Community College	8	2,007,725	3	876,089	(1,131,636)	-56.4%
Leeward Community College	13	4,260,373	6	3,064,574	(1,195,799)	-28.1%
University of Hawai'i Maui College	32	7,440,725	32	11,925,050	4,484,325	60.3%
Windward Community College	23	7,406,077	19	7,324,832	(81,245)	-1.1%
<b>Subtotal Community Colleges and UH Maui College</b>	<b>120</b>	<b>30,895,145</b>	<b>97</b>	<b>30,638,206</b>	<b>(256,939)</b>	<b>-0.8%</b>
University of Hawai'i at Hilo	141	12,881,686	133	12,950,593	68,907	0.5%
University of Hawai'i at Manoa	1,545	294,006,559	1,558	301,095,266	7,088,707	2.4%
University of Hawai'i at West O'ahu	13	5,631,172	24	6,035,273	404,101	7.2%
University of Hawai'i System	67	43,587,143	67	35,592,365	(7,994,778)	-18.3%
<b>Grand Total</b>	<b>1,886</b>	<b>387,001,705</b>	<b>1,879</b>	<b>386,311,703</b>	<b>(690,002)</b>	<b>-0.2%</b>
FY 2018 Monthly Report of Awards to Date as of June 30, 2018						
Campus Details						
Campus	FY 2017		FY 2018		\$ Change	% Change
	Award Count	Award Amount	Award Count	Award Amount		
<b>Hawai'i Community College</b>	<b>7</b>	<b>179,897</b>	<b>7</b>	<b>557,101</b>	<b>377,204</b>	<b>209.7%</b>
Chancellor, Hawai'i Community College	7	179,897	7	557,101	377,204	209.7%
Academic Affairs (Hawaii CC)	1	13,200	2	384,919	371,719	2816.1%
Liberal Arts and Public Services	1	8,000	1	13,750	5,750	71.9%
Office of Continuing Education & Training	3	95,897	2	92,407	(3,490)	-3.6%
UH Center at West Hawai'i	1	44,800	2	66,025	21,225	47.4%
Vice Chancellor for Student Affairs (Hawaii CC)	1	18,000	-	-	(18,000)	-100.0%
<b>Honolulu Community College</b>	<b>15</b>	<b>2,864,032</b>	<b>13</b>	<b>1,679,521</b>	<b>(1,184,511)</b>	<b>-41.4%</b>
Chancellor, Honolulu Community College	15	2,864,032	13	1,679,521	(1,184,511)	-41.4%
Academic Affairs (Honolulu CC)	2	542,553	1	576,039	33,486	6.2%
Chancellor, Honolulu Community College	2	267,198	6	591,783	324,585	121.5%
Early Childhood (Honolulu CC)	1	40,000	1	40,000	-	0.0%
Natural Sciences	2	1,318,891	-	-	(1,318,891)	-100.0%
Pacific Center for Advanced Technology Training	6	377,337	3	118,646	(258,691)	-68.6%
University College	2	318,053	2	353,053	35,000	11.0%
<b>Kapi'olani Community College</b>	<b>22</b>	<b>6,736,316</b>	<b>17</b>	<b>5,211,039</b>	<b>(1,525,277)</b>	<b>-22.6%</b>
Chancellor, Kapiolani Community College	22	6,736,316	17	5,211,039	(1,525,277)	-22.6%
Academic Affairs (KCC)	1	494,973	-	-	(494,973)	-100.0%
Arts and Sciences Academic Program	2	1,012,858	1	49,001	(963,857)	-95.2%
Chancellor, Kapiolani Community College	6	4,426,942	5	3,371,646	(1,055,296)	-23.8%
Continuing Education / Non-Credit Program	6	268,499	2	162,150	(106,349)	-39.6%
Culinary Arts (KCC)	1	14,994	2	132,756	117,762	785.4%
Emergency Medical Services	1	149,480	4	879,480	730,000	488.4%
Health Sciences	1	25,000	-	-	(25,000)	-100.0%
Math and Science	1	60,350	-	-	(60,350)	-100.0%
Office for Institutional Effectiveness	1	8,500	1	2,000	(6,500)	-76.5%
Office of International Affairs	1	1,037	-	-	(1,037)	-100.0%
Student Support Services	1	273,683	2	614,006	340,323	124.3%
<b>Kaua'i Community College</b>	<b>8</b>	<b>2,007,725</b>	<b>3</b>	<b>876,089</b>	<b>(1,131,636)</b>	<b>-56.4%</b>
Chancellor, Kauai Community College	8	2,007,725	3	876,089	(1,131,636)	-56.4%
Chancellor, Kauai Community College	6	1,975,742	3	876,089	(1,099,653)	-55.7%
Continuing Education and Training (Kauai CC)	2	31,983	-	-	(31,983)	-100.0%
<b>Leeward Community College</b>	<b>13</b>	<b>4,260,373</b>	<b>6</b>	<b>3,064,574</b>	<b>(1,195,799)</b>	<b>-28.1%</b>
Chancellor, Leeward Community College	13	4,260,373	6	3,064,574	(1,195,799)	-28.1%
Career and Technical Education (Leeward CC)	1	53,125	-	-	(53,125)	-100.0%
Chancellor, Leeward Community College	11	3,957,248	5	2,852,086	(1,105,162)	-27.9%
Continuing Education and Workforce Dev	1	250,000	1	212,488	(37,512)	-15.0%
<b>University of Hawai'i at Hilo</b>	<b>141</b>	<b>12,881,686</b>	<b>133</b>	<b>12,950,593</b>	<b>68,907</b>	<b>0.5%</b>
Chancellor, UH Hilo	8	1,436,257	5	1,958,215	521,958	36.3%
Chancellor, UH Hilo	8	1,436,257	5	1,958,215	521,958	36.3%
College of Agriculture, Forestry and Natural Resource Mgt	18	1,409,810	16	1,077,332	(332,478)	-23.6%
College of Agriculture, Forestry and Natural Resource Mgt	12	1,059,889	8	524,389	(535,500)	-50.5%
Pacific Aquaculture and Coastal Resources Ctr	6	349,921	8	552,943	203,022	58.0%
College of Arts and Sciences	41	4,215,798	32	2,928,225	(1,287,573)	-30.5%
Anthropology (UH Hilo)	3	407,080	2	469,881	62,801	15.4%
Art (UH Hilo)	-	-	1	10,000	10,000	100.0%
Biology (UH Hilo)	4	186,804	6	478,623	291,819	156.2%
Chemistry (UH Hilo)	-	-	2	37,500	37,500	100.0%
College of Arts and Sciences	1	275,000	1	300,000	25,000	9.1%
Geography (UH Hilo)	4	158,502	4	272,296	113,794	71.8%
Geology-Geophysics	1	1,100	1	6,768	5,668	515.3%
Humanities Division	2	21,920	-	-	(21,920)	-100.0%
Marine Science	-	-	1	24,373	24,373	100.0%
Mathematics (UH Hilo)	1	7,000	1	7,000	-	0.0%
Natural Sciences Division	19	2,900,818	8	947,972	(1,952,846)	-67.3%
Physics and Astronomy	2	145,513	3	223,812	78,299	53.8%
School of Nursing	2	12,061	-	-	(12,061)	-100.0%
Social Sciences Division	2	100,000	2	150,000	50,000	50.0%



College of Business and Economics	-	-	1	120,000	120,000	100.0%
College of Business and Economics	-	-	1	120,000	120,000	100.0%
College of Continuing Education and Community Svc	3	99,931	2	31,750	(68,181)	-68.2%
College of Continuing Education and Community Svc	3	99,931	2	31,750	(68,181)	-68.2%
College of Pharmacy	11	667,726	8	196,873	(470,853)	-70.5%
College of Pharmacy	4	89,645	3	44,290	(45,355)	-50.6%
Pharmaceutical Sciences	5	553,556	3	82,400	(471,156)	-85.1%
Pharmacy Practice	2	24,525	2	70,183	45,658	186.2%
Hawaii Small Business Development Center	7	909,979	7	1,142,235	232,256	25.5%
Hawaii Small Business Development Center	7	909,979	7	1,142,235	232,256	25.5%
Imiloa Astronomy Center Of Hawaii	9	505,336	9	832,854	327,518	64.8%
Imiloa Astronomy Center Of Hawaii	9	505,336	9	832,854	327,518	64.8%
Ka Haka'Ula O Ke'Elkolani-UHH	7	860,980	7	1,774,041	913,061	106.0%
Hale Kuamo'o Center	1	100,000	3	667,437	567,437	567.4%
Ka Haka'Ula O Ke'Elkolani-UHH	6	760,980	4	1,106,604	345,624	45.4%
Vice Chancellor for Academic Affairs (UH Hilo)	-	-	1	57,000	57,000	100.0%
Vice Chancellor for Academic Affairs (UH Hilo)	-	-	1	57,000	57,000	100.0%
Vice Chancellor for Administrative Affairs	-	-	1	2,250	2,250	100.0%
Vice Chancellor for Administrative Affairs	-	-	1	2,250	2,250	100.0%
Vice Chancellor for Research	24	874,009	32	1,482,154	608,145	69.6%
Vice Chancellor for Research	24	874,009	32	1,482,154	608,145	69.6%
Vice Chancellor for Student Affairs	13	1,901,860	12	1,347,664	(554,196)	-29.1%
Center For Gifted And Talented Native Hawaiian Children	2	7,250	1	44,800	37,550	517.9%
Upward Bound	7	1,589,877	6	811,127	(778,750)	-49.0%
Vice Chancellor for Student Affairs	4	304,733	5	491,737	187,004	61.4%
University of Hawai'i at Manoa	1,545	294,006,579	1,558	301,095,266	7,088,687	2.4%
Chancellor, UH Manoa	-	-	1	30,000	30,000	100.0%
Chancellor, UH Manoa	-	-	1	30,000	30,000	100.0%
College of Arts and Humanities	17	614,377	15	386,335	(228,042)	-37.1%
American Studies	-	-	2	104,618	104,618	100.0%
Art and Art History	1	5,290	1	2,766	(2,524)	-47.7%
College of Arts and Humanities	2	91,000	-	-	(91,000)	-100.0%
History (UH Manoa)	1	60,000	2	73,349	13,349	22.2%
Music (UH Manoa)	4	66,576	3	14,640	(51,936)	-78.0%
Philosophy (UH Manoa)	5	286,765	2	160,000	(126,765)	-44.2%
Religion (UH Manoa)	1	74,501	-	-	(74,501)	-100.0%
Theatre and Dance	2	8,245	2	13,962	5,717	69.3%
UHM Uehiro Academy for Philosophy and Ethics in Education	1	22,000	3	17,000	(5,000)	-22.7%
College of Education	55	16,177,466	65	13,415,976	(2,761,490)	-17.1%
Center on Disability Studies/University Affiliated Pgms	27	7,600,889	31	6,085,596	(1,515,293)	-19.9%
College of Education	7	4,389,863	6	2,159,783	(2,230,080)	-50.8%
Curriculum Research and Development Group	10	2,200,503	10	1,898,395	(302,108)	-13.7%
Department of Curriculum Studies	5	1,348,883	2	349,103	(999,780)	-74.1%
Department of Educational Foundations	-	-	1	44,913	44,913	100.0%
Department of Educational Psychology	2	83,722	-	-	(83,722)	-100.0%
Department of Kinesiology and Rehabilitation Science	2	305,510	10	1,047,931	742,421	243.0%
Department of Special Education	1	233,096	2	498,074	264,978	113.7%
Institute for Teacher Education	1	15,000	3	1,332,181	1,317,181	8781.2%
College of Engineering	38	4,680,411	38	3,942,763	(737,648)	-15.8%
Civil and Environmental Engineering	11	909,967	14	1,804,555	894,588	98.3%
College of Engineering	4	518,245	5	780,160	261,915	50.5%
Electrical Engineering	17	2,670,747	10	610,969	(2,059,778)	-77.1%
Mechanical Engineering	6	581,452	9	747,079	165,627	28.5%
College of Language, Linguistics and Literature	28	2,243,734	28	2,640,397	396,663	17.7%
Center for Language and Technology	2	4,170	2	16,339	12,169	291.8%
College of Language, Linguistics and Literature	3	702,548	2	867,303	164,755	23.5%
Department of East Asian Languages and Literature	6	1,210,302	7	1,306,638	96,336	8.0%
Department of English	4	35,500	5	15,581	(19,919)	-56.1%
Department of Linguistics	11	288,684	8	311,491	22,807	7.9%
Department of Second Language Studies	-	-	2	116,898	116,898	100.0%
Dept of Languages and Literatures of Europe and the Americas	2	2,530	2	6,147	3,617	143.0%
College of Natural Sciences	273	32,794,485	240	32,165,964	(628,521)	-1.9%
College of Natural Sciences	1	16,000	-	-	(16,000)	-100.0%
Department of Biology (Biology Program)	11	507,068	10	1,122,525	615,457	121.4%
Department of Botany	205	25,332,592	177	24,807,014	(525,578)	-2.1%
Department of Chemistry	11	1,104,514	11	860,546	(243,968)	-22.1%
Department of Mathematics	3	530,355	5	561,942	31,587	6.0%
Department of Microbiology	3	403,645	1	540	(403,105)	-99.9%
Department of Physics and Astronomy	25	3,519,262	27	3,968,550	449,288	12.8%
Information and Computer Sciences	14	1,381,049	9	844,847	(536,202)	-38.8%
College of Social Sciences	74	11,544,031	81	13,811,775	2,267,744	19.6%
College of Social Sciences	2	81,320	5	221,269	139,949	172.1%
Department of Anthropology	4	229,622	2	487,407	257,785	112.3%
Economics (UH Manoa)	6	182,557	8	447,115	264,558	144.9%
Ethnic Studies	3	21,902	1	10,000	(11,902)	-54.3%
Geography (UH Manoa)	5	361,210	7	472,668	111,458	30.9%
Political Science (UH Manoa)	2	78,969	1	20,742	(58,227)	-73.7%
Psychology (UH Manoa)	7	985,023	8	1,534,183	549,160	55.8%
School of Communications	3	106,300	2	36,746	(69,554)	-65.4%
Social Science Research Institute	35	4,196,620	39	5,129,045	932,425	22.2%
Social Sciences Public Policy Center	1	2,500	-	-	(2,500)	-100.0%

Sociology (UH Manoa)	2	29,079	2	35,000	5,921	20.4%
Urban and Regional Planning	3	5,236,000	6	5,417,600	181,600	3.5%
Womens Studies	1	32,929	-	-	(32,929)	-100.0%
<b>College of Tropical Agriculture and Human Resources</b>	<b>150</b>	<b>13,619,801</b>	<b>154</b>	<b>17,648,266</b>	<b>4,028,465</b>	<b>29.6%</b>
Agricultural Diagnostic Service Center	1	134,440	1	138,512	4,072	3.0%
Center on the Family	6	442,624	9	1,200,160	757,536	171.1%
College of Tropical Agriculture and Human Resources	6	689,212	6	660,457	(28,755)	-4.2%
Cooperative Extension	1	229,092	3	716,464	487,372	212.7%
Family and Consumer Sciences	4	252,622	3	141,147	(111,475)	-44.1%
Hawaii County	11	283,352	15	1,012,689	729,337	257.4%
Human Nutrition, Food and Animal Sciences	10	507,128	17	3,058,494	2,551,366	503.1%
Kauai County	1	13,800	1	13,800	-	0.0%
Maui County	7	289,629	5	339,729	50,100	17.3%
Molecular Biosciences and Bioengineering	4	483,039	4	569,897	86,858	18.0%
Natural Resources and Environmental Mgt	30	1,967,310	24	2,085,839	118,529	6.0%
Oahu County	5	845,361	5	711,080	(134,281)	-15.9%
Office of The Assoc Dean for Academic and Student Affairs	4	1,714,131	6	2,392,953	678,822	39.6%
Plant and Environmental Protection Sciences	42	4,417,113	39	3,871,180	(545,933)	-12.4%
Tropical Plant and Soil Science	18	1,350,948	16	735,865	(615,083)	-45.5%
<b>Colleges of Arts and Sciences</b>	<b>-</b>	<b>-</b>	<b>1</b>	<b>18,000</b>	<b>18,000</b>	<b>100.0%</b>
Colleges of Arts and Sciences	-	-	1	18,000	18,000	100.0%
Hawai'i Inuiaka School of Hawaiian Knowledge	6	1,996,314	5	2,555,214	558,900	28.0%
Hawai'i Inuiaka School of Hawaiian Knowledge	5	1,925,179	5	2,555,214	630,035	32.7%
Kamakakuokalani Center for Hawaiian Studies	1	71,135	-	-	(71,135)	-100.0%
<b>Institute for Astronomy</b>	<b>67</b>	<b>18,339,284</b>	<b>65</b>	<b>15,670,948</b>	<b>(2,668,336)</b>	<b>-14.5%</b>
Institute for Astronomy	67	18,339,284	65	15,670,948	(2,668,336)	-14.5%
<b>John A. Burns School of Medicine</b>	<b>222</b>	<b>61,527,128</b>	<b>214</b>	<b>59,950,931</b>	<b>(1,576,197)</b>	<b>-2.6%</b>
Associate Dean for Academic Affairs	11	2,771,655	12	3,095,827	543,285	144.1%
Department of Anatomy, Biochemistry, and Physiology	5	476,898	11	1,016,683	539,785	113.2%
Department of Cell and Molecular Biology	12	4,540,604	12	3,651,521	(889,083)	-19.6%
Department of Complementary and Alternative Medicine	-	-	4	100,943	100,943	100.0%
Department of Family Medicine and Community Health	10	1,369,653	12	2,555,495	1,185,842	86.6%
Department of Geriatric Medicine	6	2,783,168	4	916,763	(1,866,405)	-67.1%
Department of Medicine	40	8,691,796	26	3,019,009	(5,672,787)	-65.3%
Department of Native Hawaiian Health	23	3,405,808	17	2,627,439	(778,369)	-22.9%
Department of Obstetrics, Gynecology and Women's Health	23	5,342,031	11	5,260,752	(81,279)	-1.5%
Department of Pediatrics	19	6,654,639	17	3,336,392	(3,318,247)	-49.9%
Department of Psychiatry	8	4,744,291	9	5,473,332	729,041	15.4%
Department of Surgery	10	2,016,386	15	2,001,850	(14,536)	-0.7%
Department of Tropical Medicine, Medical Micro and Pharm	36	7,281,297	42	6,830,451	(450,846)	-6.2%
Institute for Biogenesis Research	4	4,576,530	1	195,492	(4,381,038)	-95.7%
John A. Burns School of Medicine	14	6,189,867	19	18,489,982	12,300,115	198.7%
Native Hawaiian Center of Excellence	1	682,505	2	1,379,000	696,495	102.0%
<b>Lyon Arboretum</b>	<b>10</b>	<b>752,957</b>	<b>8</b>	<b>478,823</b>	<b>(274,134)</b>	<b>-36.4%</b>
Lyon Arboretum	10	752,957	8	478,823	(274,134)	-36.4%
<b>Office of Research Compliance</b>	<b>-</b>	<b>-</b>	<b>1</b>	<b>49,900</b>	<b>49,900</b>	<b>100.0%</b>
Animal and Veterinary Services Program	-	-	1	49,900	49,900	100.0%
<b>Outreach College</b>	<b>9</b>	<b>165,214</b>	<b>8</b>	<b>149,263</b>	<b>(15,951)</b>	<b>-9.7%</b>
Community Programs	6	87,900	6	87,126	(774)	-0.9%
Non-Credit Programs (UH Manoa)	1	3,714	-	-	(3,714)	-100.0%
Outreach College	2	73,600	2	62,137	(11,463)	-15.6%
<b>School of Architecture</b>	<b>2</b>	<b>163,646</b>	<b>1</b>	<b>150,175</b>	<b>(13,471)</b>	<b>-8.2%</b>
School of Architecture	2	163,646	1	150,175	(13,471)	-8.2%
<b>School of Nursing and Dental Hygiene</b>	<b>9</b>	<b>1,223,918</b>	<b>13</b>	<b>2,407,654</b>	<b>1,183,736</b>	<b>96.7%</b>
Department of Nursing	6	1,150,527	10	2,298,715	1,148,188	99.8%
School of Nursing and Dental Hygiene	3	73,391	3	108,939	35,548	48.4%
<b>School of Ocean and Earth Science and Technology</b>	<b>370</b>	<b>79,154,444</b>	<b>394</b>	<b>93,144,266</b>	<b>13,989,822</b>	<b>17.7%</b>
Center for Microbial Oceanography, Research and Edu (C-MORE)	6	2,018,067	10	4,053,028	2,034,961	100.8%
Department of Atmospheric Sciences	10	3,672,408	9	1,194,182	(2,478,226)	-67.5%
Department of Geology and Geophysics	31	2,891,391	25	2,566,204	(325,187)	-11.2%
Department of Ocean and Resources Engineering	7	963,254	13	1,660,013	696,759	72.3%
Department of Oceanography	39	9,883,486	54	11,074,819	1,191,333	12.1%
Hawaii Institute of Geophysics and Planetology (HIGP)	73	8,378,171	85	10,172,044	1,793,873	21.4%
Hawaii Institute of Marine Biology (HIMB)	33	4,327,999	35	3,651,711	(676,288)	-15.6%
Hawaii Natural Energy Institute (HNEI)	11	10,016,631	13	11,560,139	1,543,508	15.4%
International Pacific Research Center (IPRC)	21	3,259,908	16	2,373,040	(886,868)	-27.2%
Joint Institute for Marine and Atmospheric Research (JIMAR)	60	15,431,191	62	22,402,008	6,970,817	45.2%
Pacific Biosciences Research Center	41	3,997,257	33	4,919,043	921,786	23.1%
School of Ocean and Earth Science and Technology	12	9,880,231	16	11,774,057	1,893,826	19.2%
Sea Grant College Program	26	4,434,450	22	4,995,218	560,768	12.6%
University Marine Center/Ship Operations	-	-	1	748,760	748,760	100.0%
<b>School of Pacific and Asian Studies</b>	<b>14</b>	<b>934,209</b>	<b>14</b>	<b>2,011,240</b>	<b>1,077,031</b>	<b>115.3%</b>
Center for Chinese Studies	6	228,099	2	221,202	(6,897)	-3.0%
Center for Japanese Studies	2	229,850	2	571,350	341,500	148.6%
Center for Korean Studies	3	202,860	5	233,273	30,413	15.0%
Center for Pacific Islands Studies	1	228,000	2	405,000	177,000	77.6%
Center for Southeast Asian Studies	1	239,400	2	579,900	340,500	142.2%
School of Pacific and Asian Studies	1	(194,000)	1	515	194,515	-100.3%
<b>School of Social Work</b>	<b>44</b>	<b>5,923,941</b>	<b>48</b>	<b>7,024,273</b>	<b>1,100,332</b>	<b>18.6%</b>
Center on Aging	3	153,480	3	165,071	11,591	7.6%
Office of Public Health Studies	28	4,297,259	32	5,676,352	1,379,093	32.1%

School of Social Work	13	1,473,202	13	1,182,850	(290,352)	-19.7%
<b>Shidler College of Business</b>	<b>2</b>	<b>269,596</b>	-	-	<b>(269,596)</b>	<b>-100.0%</b>
Department of Management and Industrial Relations	1	210,000	-	-	(210,000)	-100.0%
Shidler College of Business	1	59,596	-	-	(59,596)	-100.0%
<b>University of Hawaii Cancer Center</b>	<b>84</b>	<b>29,999,976</b>	<b>80</b>	<b>20,857,092</b>	<b>(9,142,884)</b>	<b>-30.5%</b>
Cancer Biology	20	3,742,805	10	1,337,928	(2,404,877)	-64.3%
Cancer Epidemiology	30	11,962,232	34	9,954,190	(2,008,042)	-16.8%
Cancer Prevention in the Pacific	4	660,562	4	665,218	4,656	0.7%
Translational and Clinical Research	16	10,044,494	21	3,518,671	(6,525,823)	-65.0%
University of Hawaii Cancer Center	14	3,589,883	11	5,381,085	1,791,202	49.9%
<b>Vice Chancellor, Academic Affairs</b>	<b>8</b>	<b>1,463,442</b>	<b>11</b>	<b>1,408,738</b>	<b>(54,704)</b>	<b>-3.7%</b>
Graduate Education	2	862,500	1	695,000	(167,500)	-19.4%
International & Exch Prog	1	54,582	1	56,655	2,073	3.8%
Library (UH Manoa)	2	52,719	5	106,081	53,362	101.2%
Service Learning	-	-	2	47,147	47,147	100.0%
UH Press	1	90,000	1	100,000	10,000	11.1%
Undergraduate Education	2	403,641	1	403,855	214	0.1%
<b>Vice Chancellor, Admin, Finance and Operations</b>	<b>1</b>	<b>4,807</b>	-	-	<b>(4,807)</b>	<b>-100.0%</b>
Buildings & Grounds Management	1	4,807	-	-	(4,807)	-100.0%
<b>Vice Chancellor, Research</b>	<b>-</b>	<b>-</b>	<b>2</b>	<b>24,953</b>	<b>24,953</b>	<b>100.0%</b>
Vice Chancellor, Research	-	-	2	24,953	24,953	100.0%
<b>Vice Chancellor, Students</b>	<b>15</b>	<b>6,778,650</b>	<b>16</b>	<b>4,622,694</b>	<b>(2,155,956)</b>	<b>-31.8%</b>
Health & Wellness	-	-	2	45,000	45,000	100.0%
Student Equity Excel & Diversity	12	6,050,754	10	2,752,843	(3,297,911)	-54.5%
Vice Chancellor, Students	-	-	1	1,074,955	1,074,955	100.0%
Women's Center	3	727,896	3	749,896	22,000	3.0%
<b>Water Resources Research Center</b>	<b>11</b>	<b>1,458,277</b>	<b>12</b>	<b>3,989,558</b>	<b>2,531,281</b>	<b>173.6%</b>
Water Resources Research Center	11	1,458,277	12	3,989,558	2,531,281	173.6%
<b>William S. Richardson School of Law</b>	<b>36</b>	<b>2,176,471</b>	<b>43</b>	<b>2,540,068</b>	<b>363,597</b>	<b>16.7%</b>
William S. Richardson School of Law	36	2,176,471	43	2,540,068	363,597	16.7%
<b>University of Hawai'i at West O'ahu</b>	<b>13</b>	<b>5,631,172</b>	<b>24</b>	<b>6,035,273</b>	<b>404,101</b>	<b>7.2%</b>
<b>Chancellor, UH West Oahu</b>	<b>13</b>	<b>5,631,172</b>	<b>24</b>	<b>6,035,273</b>	<b>404,101</b>	<b>7.2%</b>
Anthropology (UH WO)	-	-	3	1,800	1,800	100.0%
Chancellor, UH West Oahu	4	2,219,104	4	2,109,769	(109,335)	-4.9%
Division of Humanities	-	-	1	116,381	116,381	100.0%
Division of Social Sciences	2	231,326	6	727,847	496,521	214.6%
Education (UH WO)	1	100,000	-	-	(100,000)	-100.0%
General Business Administration	1	424,088	-	-	(424,088)	-100.0%
General Public Administration	2	378,000	-	(47,792)	(425,792)	-112.6%
Vice Chancellor for Academic Affairs (UH WO)	-	-	1	45,000	45,000	100.0%
Vice Chancellor for Student Affairs	3	2,278,654	9	3,082,268	803,614	35.3%
<b>University of Hawai'i Maui College</b>	<b>32</b>	<b>7,440,725</b>	<b>32</b>	<b>11,925,050</b>	<b>4,484,325</b>	<b>60.3%</b>
<b>Chancellor, UH Maui College</b>	<b>32</b>	<b>7,440,725</b>	<b>32</b>	<b>11,925,050</b>	<b>4,484,325</b>	<b>60.3%</b>
Academic Affairs (UH Maui College)	1	1,246	1	2,000,000	1,998,754	160413.6%
Allied Health Department	2	33,261	1	(3,070)	(36,331)	-109.2%
Chancellor, UH Maui College	14	2,419,599	20	6,305,557	3,885,958	160.6%
Continuing Education and Training (UH Maui College)	-	-	4	169,400	169,400	100.0%
Cooperative Education (UH Maui College)	2	114,523	2	9,048	(105,475)	-92.1%
Culinary Arts (UH Maui College)	1	45,000	-	-	(45,000)	-100.0%
General Education	1	800,000	1	800,000	-	0.0%
Human Services (UH Maui College)	1	1,860,888	1	1,883,888	23,000	1.2%
Information Technology (UH Maui College)	1	161,041	-	-	(161,041)	-100.0%
Music (UH Maui College)	1	500,000	1	500,000	-	0.0%
Non-Credit Programs (UH Maui College)	3	130,000	-	-	(130,000)	-100.0%
Student Affairs (UH Maui College)	4	1,341,034	1	260,227	(1,080,807)	-80.6%
University of Hawaii Center, Maui	1	34,133	-	-	(34,133)	-100.0%
<b>University of Hawai'i System</b>	<b>67</b>	<b>43,587,143</b>	<b>67</b>	<b>35,592,365</b>	<b>(7,994,778)</b>	<b>-18.3%</b>
<b>Office of the Vice President for Community Colleges</b>	<b>6</b>	<b>1,329,109</b>	<b>6</b>	<b>1,409,610</b>	<b>80,501</b>	<b>6.1%</b>
Office of the Vice President for Community Colleges	6	1,329,109	6	1,409,610	80,501	6.1%
<b>Office of the Vice President for Research and Innovation</b>	<b>15</b>	<b>8,817,197</b>	<b>19</b>	<b>8,149,281</b>	<b>(667,916)</b>	<b>-7.6%</b>
Applied Research Laboratory	12	8,606,058	18	8,142,278	(463,780)	-5.4%
Office of the Vice President for Research and Innovation	3	211,139	1	7,003	(204,136)	-96.7%
<b>Office of the VP for Academic Planning and Policy</b>	<b>21</b>	<b>10,151,665</b>	<b>19</b>	<b>4,609,372</b>	<b>(5,542,293)</b>	<b>-54.6%</b>
Hawai'i P-20 Partnerships for Education Office	14	2,457,687	16	4,390,346	1,932,659	78.6%
Office of the VP for Academic Planning and Policy	7	7,693,978	3	219,026	(7,474,952)	-97.2%
<b>Office of the VP for Information Tech/Chief Info Officer</b>	<b>23</b>	<b>23,252,872</b>	<b>22</b>	<b>21,414,102</b>	<b>(1,838,770)</b>	<b>-7.9%</b>
Maui High Performance Computing Center (MHPCC)	8	8,558,749	-	-	(8,558,749)	-100.0%
Office of the VP for Information Tech/Chief Info Officer	5	985,113	9	5,411,556	4,426,443	449.3%
Pacific Disaster Center	10	13,709,010	13	16,002,546	2,293,536	16.7%
<b>VP For Administration</b>	<b>2</b>	<b>36,300</b>	<b>1</b>	<b>10,000</b>	<b>(26,300)</b>	<b>-72.5%</b>
VP For Administration	2	36,300	1	10,000	(26,300)	-72.5%
<b>Windward Community College</b>	<b>23</b>	<b>7,406,077</b>	<b>19</b>	<b>7,324,832</b>	<b>(81,245)</b>	<b>-1.1%</b>
<b>Chancellor, Windward Community College</b>	<b>23</b>	<b>7,406,077</b>	<b>19</b>	<b>7,324,832</b>	<b>(81,245)</b>	<b>-1.1%</b>
Academic Affairs (Windward CC)	1	49,975	-	-	(49,975)	-100.0%
Chancellor, Windward Community College	21	7,323,102	19	7,324,832	1,730	0.0%
Vocational and Community Education	1	33,000	-	-	(33,000)	-100.0%
<b>Grand Total</b>	<b>1,886</b>	<b>387,001,725</b>	<b>1,879</b>	<b>386,311,703</b>	<b>(690,022)</b>	<b>-0.2%</b>



# 2018

## ANNUAL REPORT

EXTRAMURAL AWARDS & EXPENDITURES

JULY 1, 2017 THROUGH JUNE 30, 2018



# Table of Contents

Letter from Vice President for Research and Innovation Vassilis L. Syrmos ..... 1

**Proposals and Awards**

Chart 1: Awards by Sponsor ..... 3

Figure 1: Contract and Grant Awards Summary by Sponsor Type ..... 4

Chart 2: Breakdown of Federal and Non-Federal Awards – Five Year Comparison ..... 5

Figure 2: Summary of Federal and Non-Federal Awards – Five Year Comparison ..... 5

Chart 3a: Non-Federal Awards by Fiscal Year – Five Year Comparison ..... 6

Chart 3b: Federal Awards by Fiscal Year – Five Year Comparison ..... 7

Figure 3: Total Contract and Grant Awards Received – Five Year Comparison ..... 8

Chart 4: Number of Proposals Submitted – Prior Year Comparison ..... 9

Chart 5: Total Dollar Amount of Proposals Submitted – Prior Year Comparison ..... 10

Figure 4: Proposal Summary by Source of Funding – Prior Year Comparison ..... 11

Chart 6: Total Contract and Grant Awards – Twelve Year Comparison ..... 12

Figure 5: Total Contract and Grant Awards Summary – Twelve Year Comparison ..... 12

Figure 6: Top Individual Awards ..... 13

Figure 7: Top Fifty Principal Investigators in Award Dollars ..... 14

Chart 7: Contract and Grant Awards by Campus ..... 15

Chart 8: UH Manoa – Contract and Grant Awards by College/Department ..... 16

Chart 9: UH Hilo – Contract and Grant Awards by College/Department ..... 17

Figure 8: Contract and Grant Awards Summary by Campus ..... 18

Figure 9a: UH Manoa – Contract and Grant Awards Summary by College/Department ..... 19

Figure 9b: UH Hilo – Contract and Grant Awards Summary by College/Department ..... 23

**Expenditures**

Chart 10: Total Contract and Grant Expenditures by Source of Funds – Two Year Comparison ..... 25

Figure 10: Total Contract and Grant Expenditures by Source of Funds – Two Year Comparison ..... 26

Chart 11: Total Contract and Grant Expenditures by Program Type and Source of Funds ..... 27

Figure 11: Total Contract and Grant Expenditures by Program Type and Source of Funds ..... 28

Chart 12: Total FTE Paid from Contract and Grant Funds ..... 29

Figure 12: Total FTE Paid from Contract and Grant Funds ..... 30

Chart 13: Breakdown of Facilities and Administrative Costs by Major Category – FY 2016 Base Year ..... 31

Chart 14: Total Royalties Received from University Patents – Five Year Comparison ..... 32

Figure 13: Total Royalties Received from University Patents – Five Year Comparison ..... 33

Appendix 1: Extramural Award Sponsors ..... 34



Dear Colleagues:

Extramural research award funding levels remain flat for the University of Hawai'i and other research institutions across the country, as the largest U.S. research spending package approved by the White House and Congress in over a decade necessitates the continued realignment of R&D funding priorities nationally.

In FY2018, the University of Hawai'i's extramural awards totaled \$386 million, similar to the previous year's tally. As we continue to endure the ups and downs in federal funding and work to make adjustments in our strategy, we can find some solace in that we have managed to keep our extramural funding relatively stable in the neighborhood of \$400 million over the last few years. Here are some of the highlights from FY2018:

- The Hawai'i Natural Energy Institute (HNEI) received an award from the Office of Naval Research (ONR) for its Asia-Pacific Research Initiative for Sustainable Energy Systems (APRISES). The ONR also awarded HNEI for its Asian Pacific Regional Energy System Assessment (APRESA).
- The John A. Burns School of Medicine received an award from the U.S. Department of Health and Human Services for its Ola HAWAII program designed to tackle genetic, environmental and socio-economic related disparities in health/healthcare for underrepresented populations in the state.
- The Pacific Disaster Center (PDC) received an award from the U.S. Department of Defense to enable UH's continued management and resources of the Maui-based unit that fosters disaster resiliency and risk reduction through the use of science, information and technology.

This past fiscal year saw the University of Hawai'i at Mānoa's School of Ocean and Earth Science and Technology(SOEST) bring in a record \$93 million in extramural funding. With its multiple disciplines, SOEST researchers have been highly visible with their work on recent "hot topic" areas including volcanology, sea level rise, sustainable energy, microbiome, and coral reef studies. SOEST continues to be one of the most prestigious schools in the nation as shown by the broader impact of research and scholarship conducted by its faculty and students.

Your continued efforts in this era of uncertain federal R&D investments is greatly appreciated as we continue to move the University of Hawai'i forward to help drive innovation, knowledge and economic development to help better our state and world around us. As always, thank you for making the UH research enterprise a large part of your DNA.

Sincerely,

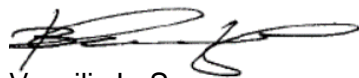

Vassillis L. Syrmos

Vice President for Research and Innovation





**Chart 1: Awards by Sponsor**  
(in millions)

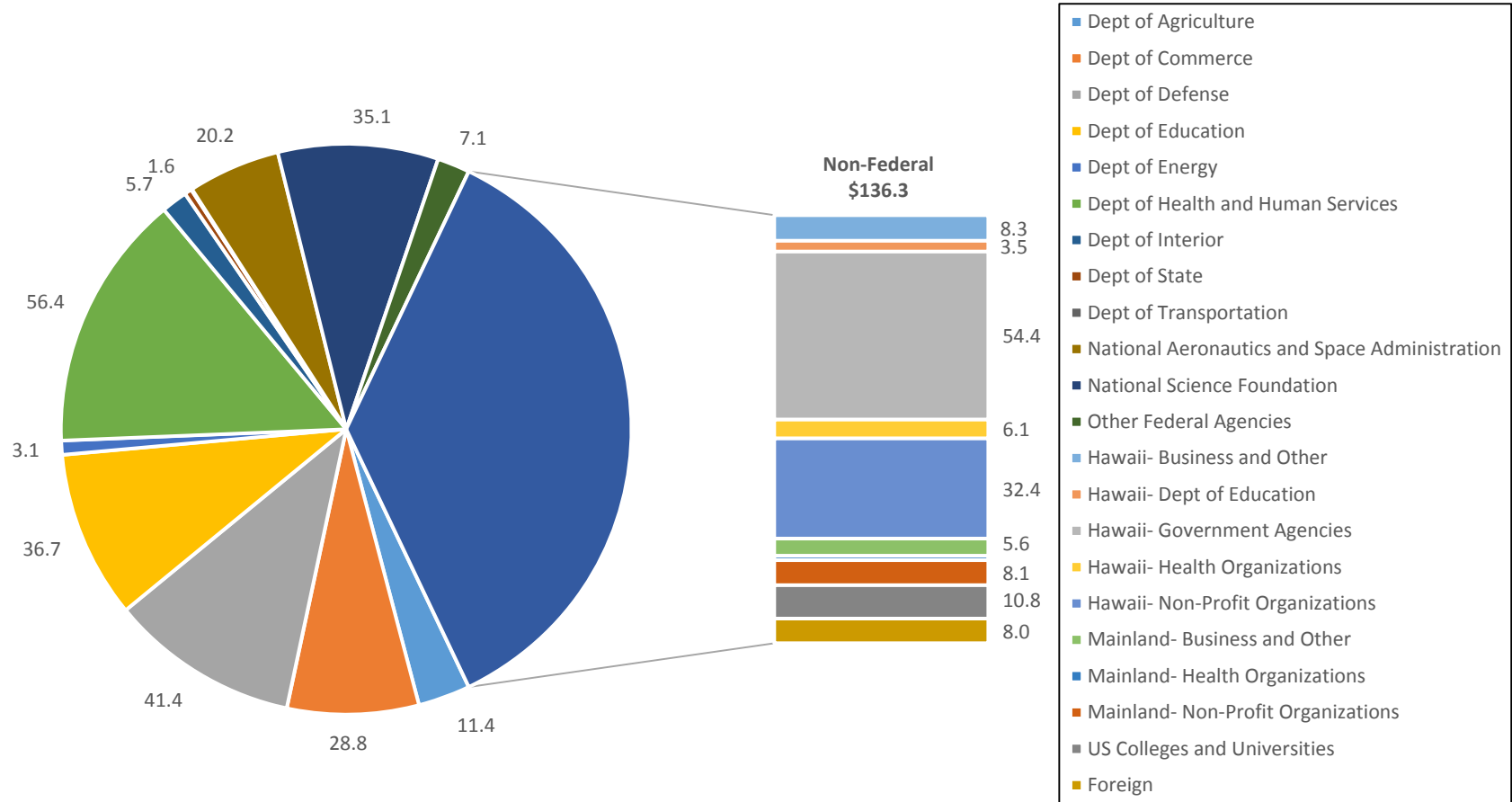

**Figure 1: Contract and Grant Awards Summary by Sponsor Type**

<b>Sponsor Type</b>	<b>Award Count</b>	<b>Amount Awarded</b>
Dept of Agriculture	68	11,433,935
Dept of Commerce	88	28,794,795
Dept of Defense	91	41,426,235
Dept of Education	71	36,737,371
Dept of Energy	10	3,145,417
Dept of Health and Human Services	117	56,358,106
Dept of Interior	73	5,737,236
Dept of State	2	1,550,000
Dept of Transportation	3	164,625
National Aeronautics and Space Administration	95	20,167,908
National Science Foundation	91	35,078,731
Other Federal Agencies	15	7,147,155
Hawaii- Business and Other	73	8,321,278
Hawaii- Dept of Education	20	3,513,321
Hawaii- Government Agencies	343	54,395,732
Hawaii- Health Organizations	35	6,067,920
Hawaii- Non-Profit Organizations	301	32,407,127
Mainland- Business and Other	70	5,572,124
Mainland- Health Organizations	9	1,443,529
Mainland- Non-Profit Organizations	96	8,065,294
US Colleges and Universities	151	10,799,689
Foreign	57	7,984,175
<b>Grand Total</b>	<b>1,879</b>	<b>386,311,703</b>

**Chart 2: Breakdown of Federal and Non-Federal Awards  
FYs 2014 to 2018**

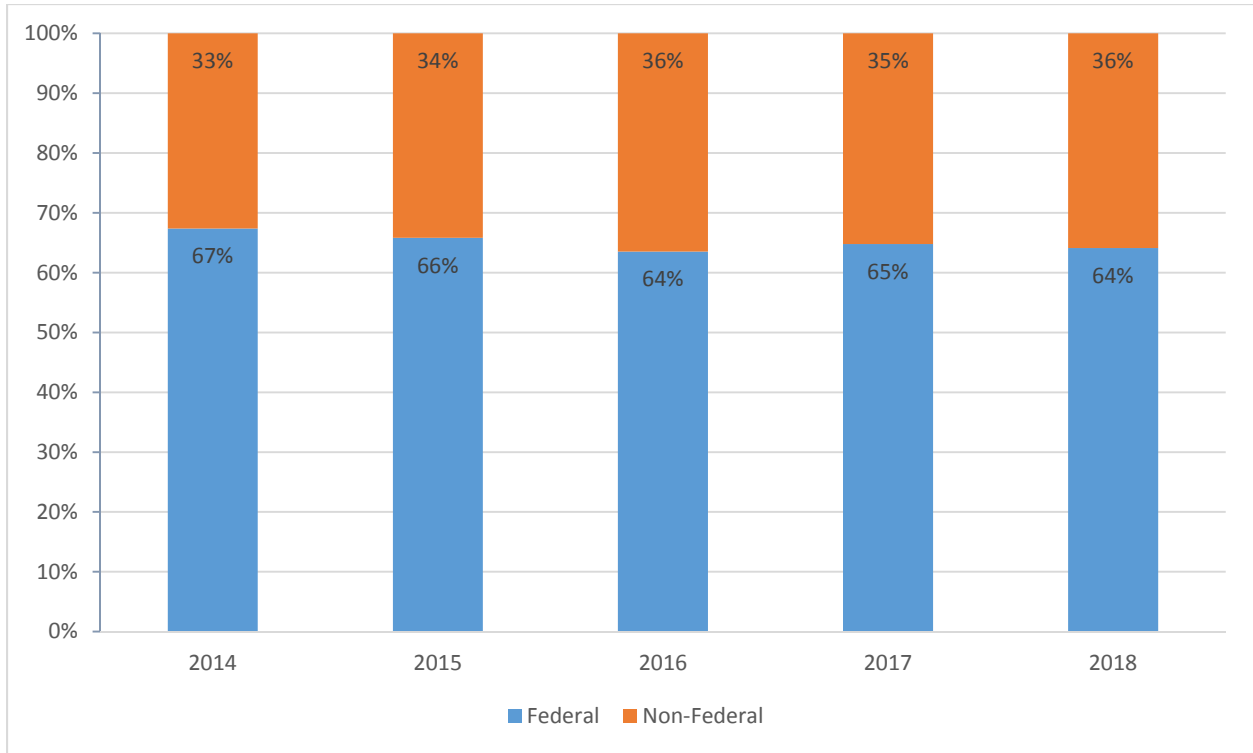

**Figure 2: Summary of Federal and Non-Federal Awards**

Source of Funding	FY 2014 Amount Awarded	FY 2015 Amount Awarded	FY 2016 Amount Awarded	FY 2017 Amount Awarded	FY 2018 Amount Awarded
Federal	264,380,218	280,181,968	248,575,207	250,727,105	247,741,514
Non-Federal	127,934,737	145,468,370	142,759,321	136,274,600	138,570,189
<b>Total</b>	<b>392,314,955</b>	<b>425,650,338</b>	<b>391,334,528</b>	<b>387,001,705</b>	<b>386,311,703</b>

**Chart 3a: Non-Federal Awards by Fiscal Year**  
**FYs 2014 to 2018**  
(in millions)

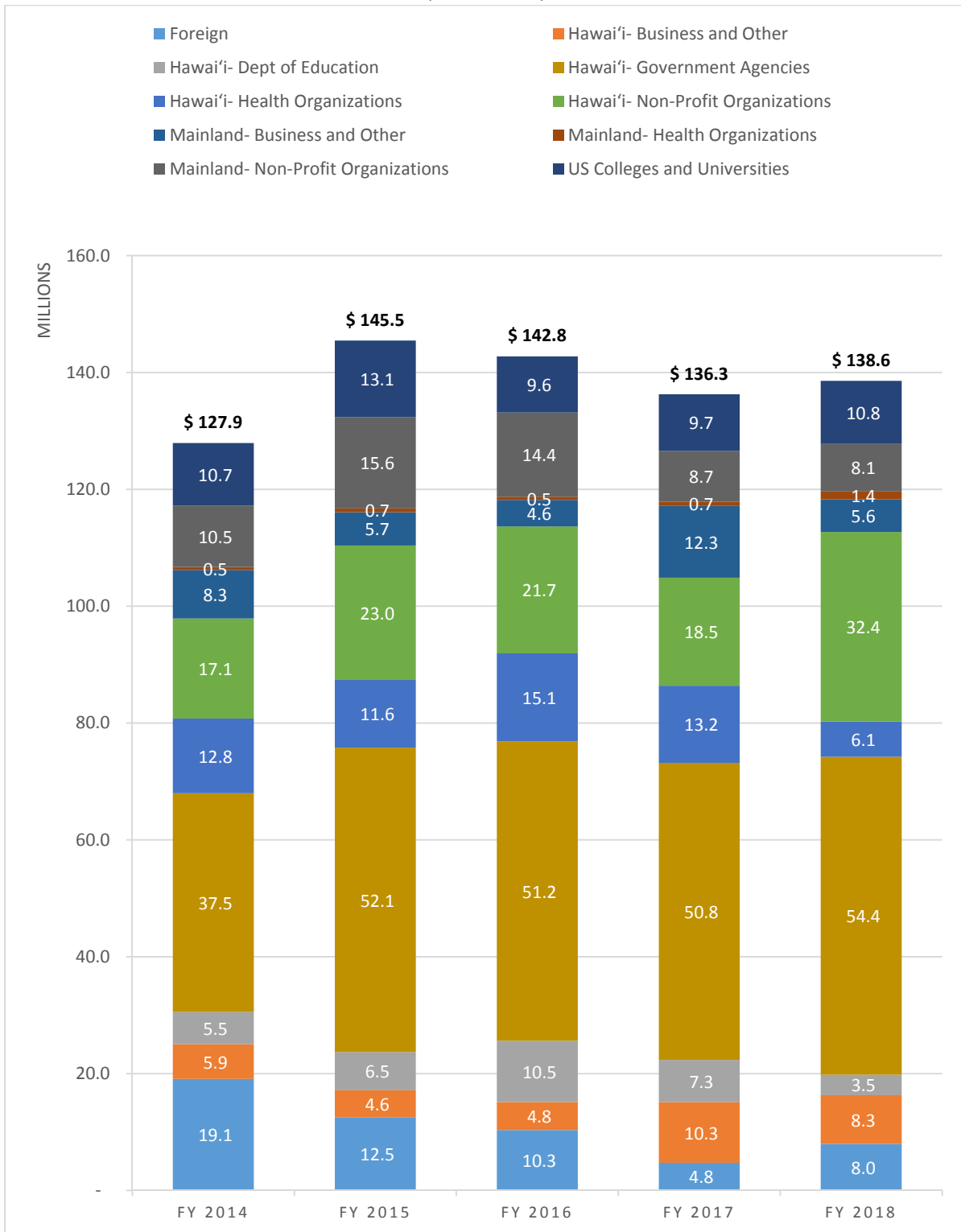

**Chart 3b: Federal Awards by Fiscal Year**  
**FYs 2014 to 2018**  
(in millions)

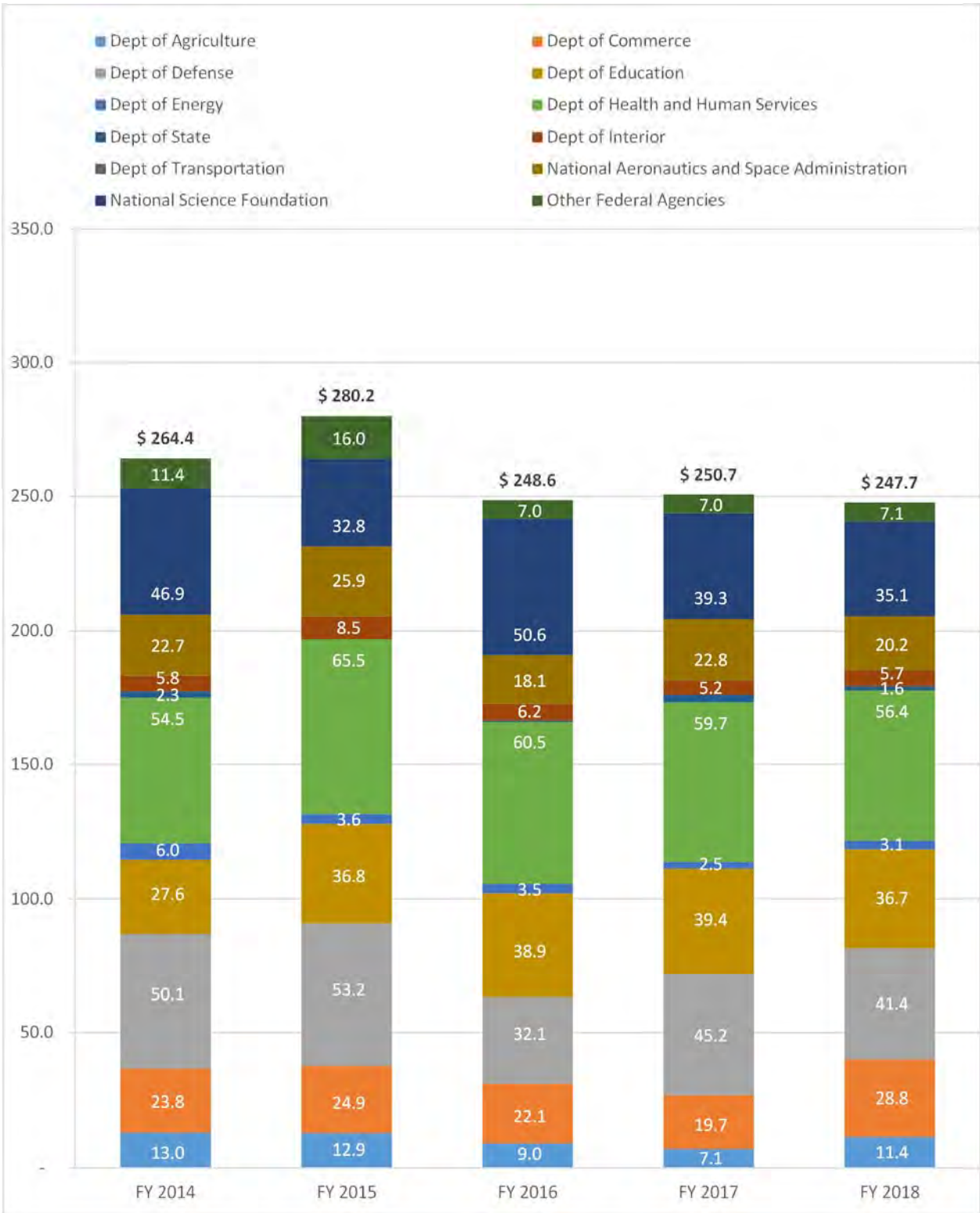

**Figure 3: Total Contract and Grant Awards Received  
FYs 2014 to 2018**

Source of Funding		FY 2014		FY 2015		FY 2016		FY 2017		FY 2018	
		Amount Awarded	% of Total	Amount Awarded	% of Total	Amount Awarded	% of Total	Amount Awarded	% of Total	Amount Awarded	% of Total
Federal	Dept of Agriculture	13,040,882	2%	12,885,870	2%	9,025,934	1%	7,104,681	1%	11,433,935	3%
	Dept of Commerce	23,781,052	4%	24,909,828	4%	22,140,488	3%	19,746,151	3%	28,794,795	7%
	Dept of Defense	50,125,047	8%	53,176,313	8%	32,051,837	5%	45,153,420	7%	41,426,235	11%
	Dept of Education	27,645,649	4%	36,808,161	5%	38,931,435	6%	39,355,136	6%	36,737,371	10%
	Dept of Energy	6,008,761	1%	3,649,991	1%	3,452,402	1%	2,454,683	0%	3,145,417	1%
	Dept of Health and Human Services	54,540,150	8%	65,517,844	9%	60,546,030	9%	59,662,559	9%	56,358,106	15%
	Dept of State	2,335,534	0%	-	0%	499,247	0%	2,741,488	0%	1,550,000	0%
	Dept of Interior	5,847,479	1%	8,505,102	1%	6,188,553	1%	5,240,402	1%	5,737,236	1%
	Dept of Transportation	10,000	0%	-	0%	75,000	0%	138,907	0%	164,625	0%
	National Aeronautics and Space Administration	22,702,185	3%	25,912,694	4%	18,106,716	3%	22,811,204	4%	20,167,908	5%
	National Science Foundation	46,939,627	7%	32,835,093	5%	50,584,187	8%	39,285,739	6%	35,078,731	9%
Other Federal Agencies	11,403,852	2%	15,981,072	2%	6,973,378	1%	7,032,735	1%	7,147,155	2%	
<b>Federal Total</b>	<b>264,380,218</b>	<b>40%</b>	<b>280,181,968</b>	<b>40%</b>	<b>248,575,207</b>	<b>39%</b>	<b>250,727,105</b>	<b>39%</b>	<b>247,741,514</b>	<b>64%</b>	
Non-Federal	Foreign	19,089,519	3%	12,538,417	2%	10,348,765	2%	4,755,142	1%	7,984,175	2%
	Hawaii- Business and Other	5,931,549	1%	4,604,200	1%	4,785,442	1%	10,338,044	2%	8,321,278	2%
	Hawaii- Dept of Education	5,519,860	1%	6,548,702	1%	10,492,291	2%	7,260,253	1%	3,513,321	1%
	Hawaii- Government Agencies	37,455,983	6%	52,087,837	7%	51,241,567	8%	50,826,152	8%	54,395,732	14%
	Hawaii- Health Organizations	12,781,158	2%	11,605,915	2%	15,056,100	2%	13,215,267	2%	6,067,920	2%
	Hawaii- Non-Profit Organizations	17,105,305	3%	23,008,349	3%	21,714,557	3%	18,483,113	3%	32,407,127	8%
	Mainland- Business and Other	8,310,778	1%	5,686,262	1%	4,553,990	1%	12,276,122	2%	5,572,124	1%
	Mainland- Health Organizations	505,858	0%	656,742	0%	531,480	0%	737,744	0%	1,443,529	0%
	Mainland- Non-Profit Organizations	10,512,867	2%	15,607,861	2%	14,414,632	2%	8,685,769	1%	8,065,294	2%
	US Colleges and Universities	10,721,860	2%	13,124,085	2%	9,620,497	2%	9,696,994	2%	10,799,689	3%
<b>Non-Federal Total</b>	<b>127,934,737</b>	<b>19%</b>	<b>145,468,370</b>	<b>21%</b>	<b>142,759,321</b>	<b>22%</b>	<b>136,274,600</b>	<b>21%</b>	<b>138,570,189</b>	<b>36%</b>	
<b>Grand Total</b>	<b>656,695,173</b>	<b>60%</b>	<b>705,832,306</b>	<b>60%</b>	<b>639,909,735</b>	<b>61%</b>	<b>637,728,810</b>	<b>61%</b>	<b>386,311,703</b>	<b>100%</b>	

**Chart 4: Number of Proposals Submitted  
FYs 2017 and 2018**

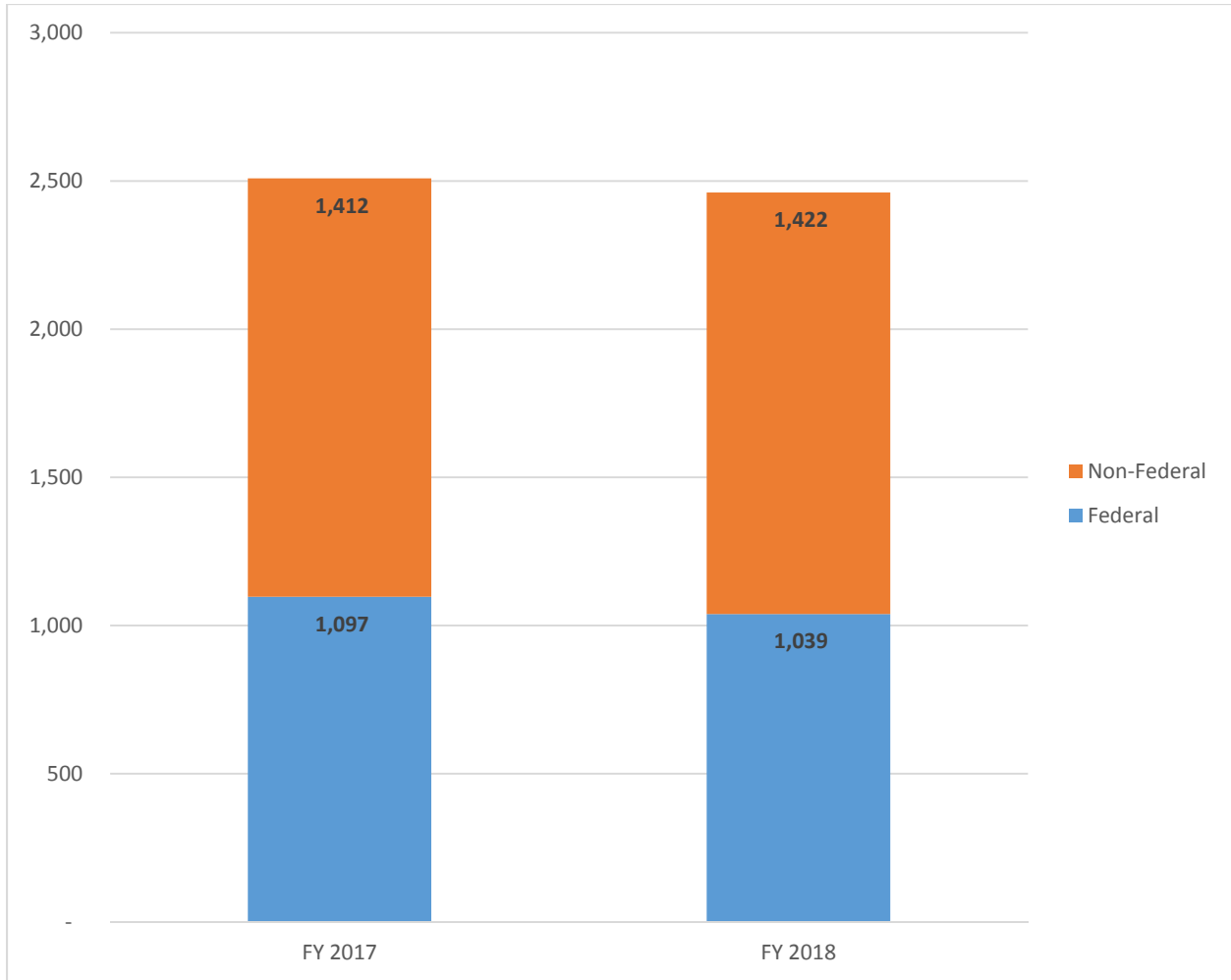



**Chart 5: Total Dollar Amount of Proposals Submitted**  
**FYs 2017 and 2018**  
(in millions)

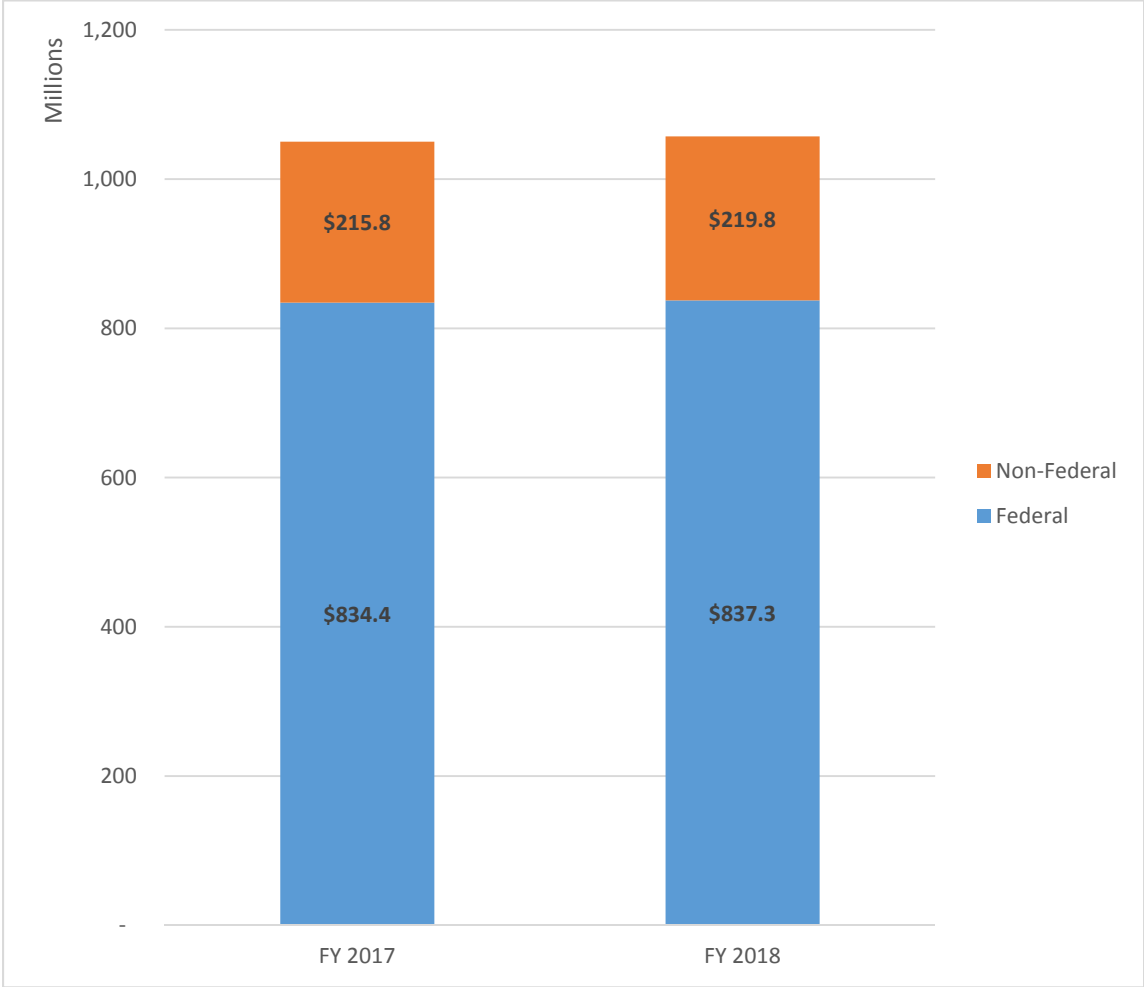

**Figure 4: Proposal Summary by Source of Funding  
FYs 2017 and 2018**

Source of Funding		FY 2017		FY 2018	
		Proposals Submitted	Requested Amount	Proposals Submitted	Requested Amount
Federal	Dept of Agriculture	115	44,301,826	115	33,697,357
	Dept of State	5	4,417,035	4	6,799,087
	Dept of Health and Human Services	200	311,448,092	205	377,830,439
	Dept of Commerce	112	45,019,133	127	62,934,149
	Dept of Defense	71	77,270,623	99	82,100,756
	Dept of Energy	10	4,500,410	20	15,474,736
	Dept of the Interior	76	7,977,393	53	5,766,967
	Dept of Transportation	3	249,625	2	215,000
	Dept of Education	69	100,304,828	23	22,323,489
	Other Federal Agencies	38	11,957,386	50	13,058,801
	National Aeronautics and Space Administration	109	92,127,025	125	42,451,807
National Science Foundation	289	134,820,980	216	174,691,315	
<b>Federal Total</b>		<b>1,097</b>	<b>834,394,356</b>	<b>1,039</b>	<b>837,343,903</b>
Non-Federal	Foreign	80	8,548,097	71	11,677,932
	Hawaii- Business and Other	79	11,501,718	79	9,800,729
	Hawaii- Dept of Education	26	7,052,830	26	4,788,471
	Hawaii- Government Agencies	411	65,961,782	381	61,895,890
	Hawaii- Health Organizations	38	14,293,118	45	9,867,940
	Hawaii- Non-Profit Organizations	336	23,676,793	352	34,728,674
	Mainland- Business and Other	91	14,156,983	118	16,518,893
	Mainland- Health Organizations	27	7,862,160	27	8,562,788
	Mainland- Non-Profit Organizations	148	20,797,745	146	20,075,665
	US Colleges and Universities	176	41,913,878	177	41,898,790
<b>Non-Federal Total</b>		<b>1,412</b>	<b>215,765,104</b>	<b>1,422</b>	<b>219,815,772</b>
<b>Grand Total</b>		<b>2,509</b>	<b>1,050,159,460</b>	<b>2,461</b>	<b>1,057,159,675</b>

**Chart 6: Total Contract and Grant Awards – FYs 2007 to 2018**  
(in millions)

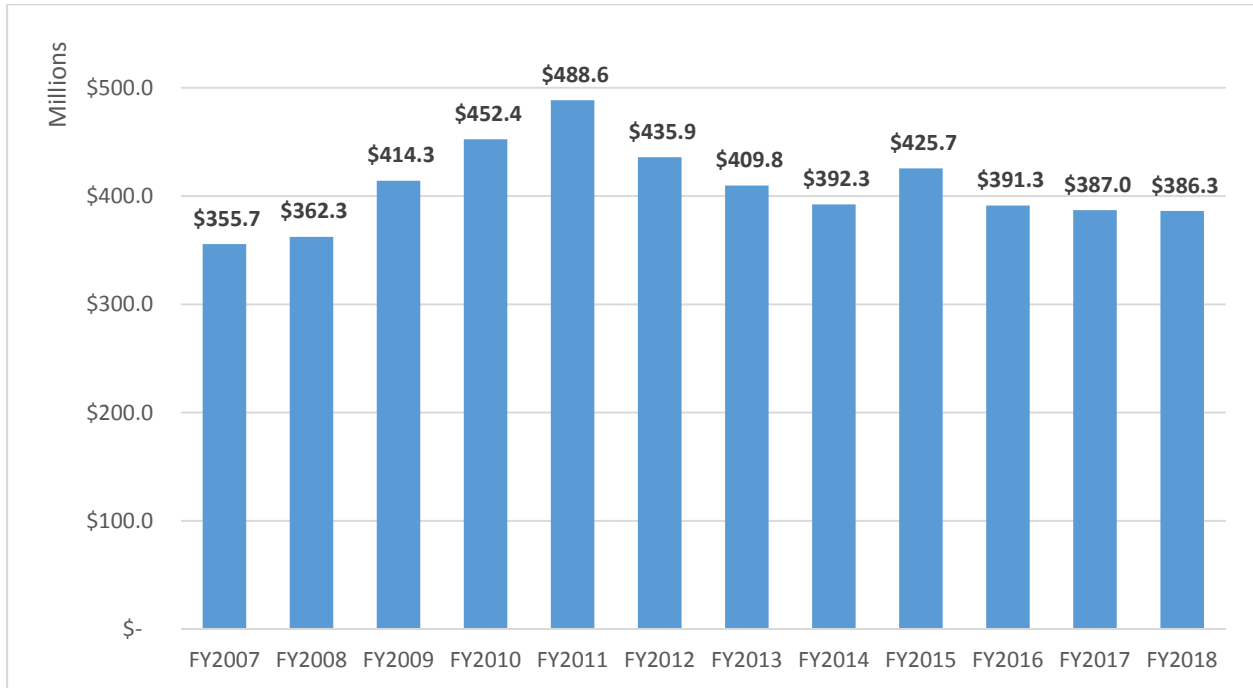

**Figure 5: Total Contract and Grant Awards Summary  
FYs 2007 to 2018**

Year	Total Awarded	% Change	Year	Total Awarded	% Change
FY2007	355,724,605	-18%	FY2013	409,783,318	-6%
FY2008	362,289,909	2%	FY2014	392,314,955	-4%
FY2009	414,260,208	14%	FY 2015	425,650,338	8%
FY2010	452,408,669	9%	FY 2016	391,334,528	-8%
FY2011	488,597,908	8%	FY 2017	387,001,705	-1%
FY2012	435,874,967	-11%	FY2018	386,311,703	-0.2%

**Figure 6: Top Individual Awards**

<b>Award Amount</b>	<b>PI Name</b>	<b>Department</b>	<b>Award Sponsor</b>	<b>Title</b>
14,243,589	David Lassner	Pacific Disaster Center	Defense, Dept-Deputy Undr Secretary of Def	University of Hawaii Pacific Disaster Center (UoH PDC) Cooperative Agreement
9,263,150	Jerris Hedges	John A. Burns School of Medicine	Health & Human Svc, Dept-NIH-Fed Natl Inst Min Hlth & Disp	Ola HAWAII
6,040,103	Richard Rocheleau	Hawaii Natural Energy Institute (HNEI)	Defense, Dept-Navy Ofc of Naval Rsch	Asia Pacific Research Initiative for Sustainable Energy Systems 2017 (APRISES17)
5,899,218	David Lassner	Applied Research Laboratory	Defense, Dept-Air Force Research Laboratory	Research and Development for DoD Vanguard Center of High Performance Computing
5,000,000	Karl E Kim	Urban and Regional Planning	Homeland Security, Dept-Fema	National Disaster Preparedness Training Center
4,663,435	Richard Wainscoat	Institute for Astronomy	National Aeronaut & Space Adm	NEO Discovery with Dedicated Pan-STARRS1 and Pan-STARRS2 Telescopes
4,575,426	Ivica Zalud	Department of Obstetrics, Gynecology and Women's Health	University Health Partners	Reimbursement Agreement No. SF18 UCERA-OBGYN
4,531,789	Richard Rocheleau	Hawaii Natural Energy Institute (HNEI)	Defense, Dept-Navy Ofc of Naval Rsch	Asia Pacific Regional Energy System Assessment (APRESA)
3,728,219	Alexander Shor	School of Ocean and Earth Science and Technology	National Science Foundation	R/V Kilo Moana Ship Operations CY18-22
3,646,315	Anthony Guerrero	Department of Psychiatry	University Health Partners	Reimbursement Agreement No. SF18 UCERA-PSYCH
3,633,000	Gwen Jacobs	Office of the VP for Information Tech/Chief Info Officer	National Science Foundation	EPSCoR RII Track 1: Ike Wai: Insuring Hawaii's Water Future
3,521,129	Robert Nichols	John A. Burns School of Medicine	Health & Human Svc, Dept-NIH-Fed Ntl Inst Gen Med Sci	INBRE IV - Hawaii Statewide Research and Education Partnership (HiSREP)

## Figure 7: Top Fifty Principal Investigators in Award Dollars

Rank	Investigator	Total Awarded	Unit
1	David Lassner	23,293,175	President, University of Hawai'i System
2	David Duffy	17,347,397	College of Natural Sciences
3	Mark Merrifield	16,337,844	School of Ocean and Earth Science and Technology
4	Alexander Shor	11,904,827	School of Ocean and Earth Science and Technology
5	Richard Rocheleau	10,314,083	School of Ocean and Earth Science and Technology
6	Jerris Hedges	9,564,011	John A. Burns School of Medicine
7	Clifford Morden	7,145,727	College of Natural Sciences
8	Lui Hokoana	5,971,974	Chancellor, UH Maui College
9	Ardis Eschenberg	5,274,753	Chancellor, Windward Community College
10	Karl E Kim	5,237,000	College of Social Sciences
11	David Karl	5,136,246	School of Ocean and Earth Science and Technology
12	Ivica Zalud	5,055,968	John A. Burns School of Medicine
13	Richard Wainscoat	4,777,679	Institute for Astronomy
14	Loic Le Marchand	4,665,783	University of Hawaii Cancer Center
15	Judy Oliveira	4,562,315	Chancellor, UH West Oahu
16	Stephen A Schatz	4,063,258	Office of the VP for Academic Planning and Policy
17	Bruce Shiramizu	4,051,973	John A. Burns School of Medicine
18	Robert Nichols	3,944,764	John A. Burns School of Medicine
19	Anthony Guerrero	3,926,789	John A. Burns School of Medicine
20	Darren Lerner	3,819,485	School of Ocean and Earth Science and Technology
21	Gwen Jacobs	3,723,000	Office of the VP for Information Tech/Chief Info Officer
22	Melissa Iwamoto	3,428,540	School of Ocean and Earth Science and Technology
23	Marek Kirs	3,388,611	Water Resources Research Center
24	Kelley Withy	3,095,827	John A. Burns School of Medicine
25	John Rayner	3,048,776	Institute for Astronomy
26	David Napoleon	2,735,952	Chancellor, Kapiolani Community College
27	Neal Palafox	2,734,430	John A. Burns School of Medicine
28	Mariana Gerschenson	2,482,035	John A. Burns School of Medicine
29	Randall F Holcombe	2,416,000	University of Hawaii Cancer Center
30	Rachel Novotny	2,125,903	College of Tropical Agriculture and Human Resources
31	Kenneth Nakamura	2,119,332	John A. Burns School of Medicine
32	Haosheng Lin	2,062,724	Institute for Astronomy
33	Mark Lane	1,998,368	Chancellor, Leeward Community College
34	Kenric M Murayama	1,945,850	John A. Burns School of Medicine
35	Axel T Lehrer	1,935,705	John A. Burns School of Medicine
36	Lee Stein	1,883,888	Chancellor, UH Maui College
37	Kenneth Kaneshiro	1,873,551	School of Ocean and Earth Science and Technology
38	Brenda Yukari Hernandez	1,870,418	University of Hawaii Cancer Center
39	Michael Melzer	1,706,139	College of Tropical Agriculture and Human Resources
40	Margaret Mcfall-Ngai	1,690,407	School of Ocean and Earth Science and Technology
41	Norman Okamura	1,656,737	College of Social Sciences
42	Satoru Izutsu	1,556,542	John A. Burns School of Medicine
43	Thomas Browder	1,525,000	College of Natural Sciences
44	Winona Lee	1,505,579	John A. Burns School of Medicine
45	Anupam Misra	1,486,754	School of Ocean and Earth Science and Technology
46	Sharon Ziegler	1,482,277	Vice Chancellor for Research
47	Donald Straney	1,410,715	Chancellor, UH Hilo
48	Joseph Kaholokula	1,410,136	John A. Burns School of Medicine
49	Lishomwa Chakanga Ndhlovu	1,409,711	John A. Burns School of Medicine
50	Rebekah Rodericks	1,357,080	School of Social Work

**Chart 7: Contract and Grant Awards by Campus**  
(in millions)

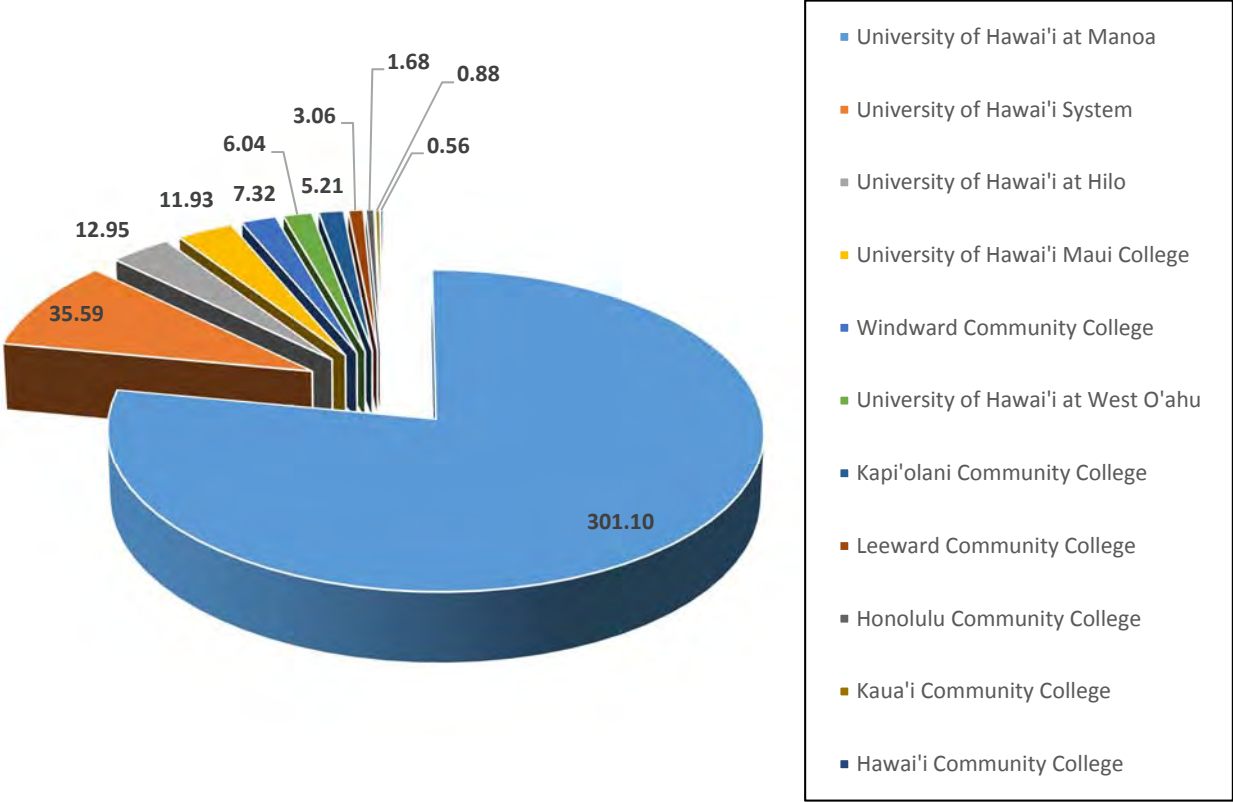

### Chart 8: UH Manoa - Contract and Grant Awards by College/Department (in millions)

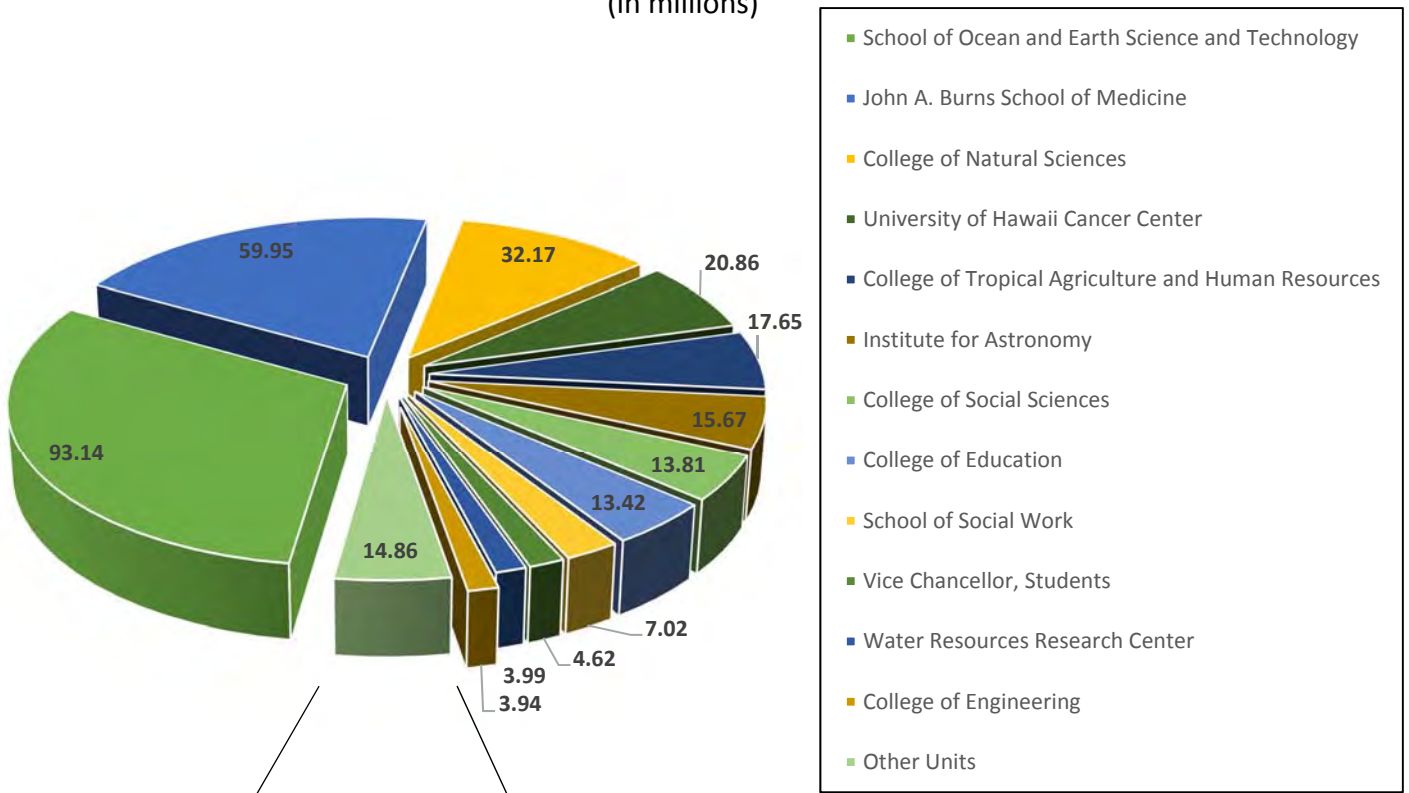

Other Units

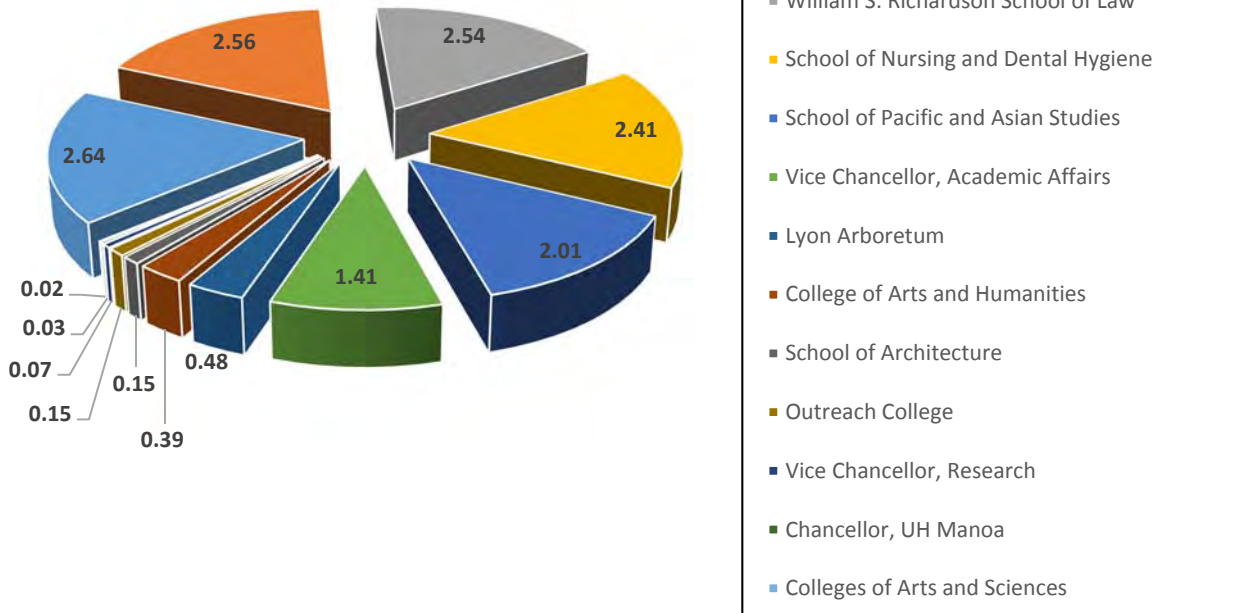

**Chart 9: UH Hilo - Contract and Grant Awards by College/Department**  
(in millions)

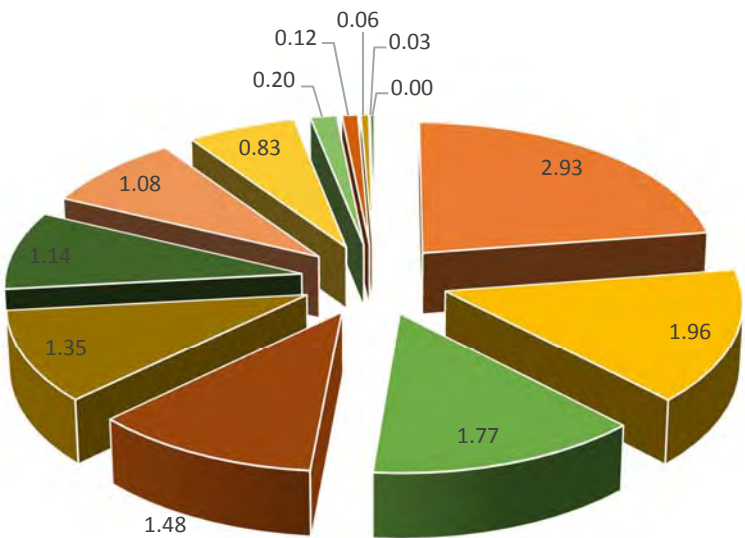

- College of Arts and Sciences
- Chancellor, UH Hilo
- Ka Haka'Ula O Ke'Elikolani-UHH
- Vice Chancellor for Research
- Vice Chancellor for Student Affairs
- Hawaii Small Business Development Center
- College of Agriculture, Forestry and Natural Resource Mgt.
- Imiloa Astronomy Center Of Hawaii
- College of Pharmacy
- College of Business and Economics
- Vice Chancellor for Academic Affairs (UH Hilo)
- College of Continuing Education and Community Svc
- Vice Chancellor for Administrative Affairs



**Figure 8: Contract and Grant Awards Summary by Campus**

<b>Campus</b>	<b>Award Amount</b>	<b>Award Count</b>	<b>% of Total</b>
Hawai'i Community College	557,101	7	0.4%
Honolulu Community College	1,679,521	13	0.7%
Kapi'olani Community College	5,211,039	17	0.9%
Kaua'i Community College	876,089	3	0.2%
Leeward Community College	3,064,574	6	0.3%
University of Hawai'i at Hilo	12,950,593	133	7.1%
University of Hawai'i at Manoa	301,095,266	1,558	82.9%
University of Hawai'i at West O'ahu	6,035,273	24	1.3%
University of Hawai'i Maui College	11,925,050	32	1.7%
University of Hawai'i System	35,592,365	67	3.6%
Windward Community College	7,324,832	19	1.0%
<b>Grand Total</b>	<b>386,311,703</b>	<b>1,879</b>	<b>100.0%</b>

**Figure 9a: UH Manoa - Contract and Grant Awards Summary  
by College/Department**

<b>UH Manoa College/Department</b>	<b>Award Amount</b>	<b>Award Count</b>	<b>% of Total</b>
<b>Chancellor, UH Manoa</b>	<b>30,000</b>	<b>1</b>	<b>0.06%</b>
Chancellor, UH Manoa	30,000	1	0.06%
<b>College of Arts and Humanities</b>	<b>386,335</b>	<b>15</b>	<b>0.96%</b>
American Studies	104,618	2	0.13%
Art and Art History	2,766	1	0.06%
History	73,349	2	0.13%
Music	14,640	3	0.19%
Philosophy	160,000	2	0.13%
Theatre and Dance	13,962	2	0.13%
UHM Uehiro Academy for Philosophy and Ethics in Education	17,000	3	0.19%
<b>College of Education</b>	<b>13,415,976</b>	<b>65</b>	<b>4.17%</b>
Center on Disability Studies/University Affiliated Pgms	6,085,596	31	1.99%
College of Education	2,159,783	6	0.39%
Curriculum Research and Development Group	1,898,395	10	0.64%
Department of Curriculum Studies	349,103	2	0.13%
Department of Educational Foundations	44,913	1	0.06%
Department of Kinesiology and Rehabilitation Science	1,047,931	10	0.64%
Department of Special Education	498,074	2	0.13%
Institute for Teacher Education	1,332,181	3	0.19%
<b>College of Engineering</b>	<b>3,942,763</b>	<b>38</b>	<b>2.44%</b>
Civil and Environmental Engineering	1,804,555	14	0.90%
College of Engineering	780,160	5	0.32%
Electrical Engineering	610,969	10	0.64%
Mechanical Engineering	747,079	9	0.58%
<b>College of Language, Linguistics and Literature</b>	<b>2,640,397</b>	<b>28</b>	<b>1.80%</b>
Center for Language and Technology	16,339	2	0.13%
College of Language, Linguistics and Literature	867,303	2	0.13%
Department of East Asian Languages and Literature	1,306,638	7	0.45%
Department of English	15,581	5	0.32%
Department of Linguistics	311,491	8	0.51%
Department of Second Language Studies	116,898	2	0.13%
Dept of Languages and Literatures of Europe and the Americas	6,147	2	0.13%
<b>College of Natural Sciences</b>	<b>32,165,964</b>	<b>240</b>	<b>15.40%</b>
Department of Biology (Biology Program)	1,122,525	10	0.64%
Department of Botany	24,807,014	177	11.36%
Department of Chemistry	860,546	11	0.71%
Department of Mathematics	561,942	5	0.32%
Department of Microbiology	540	1	0.06%

Department of Physics and Astronomy	3,968,550	27	1.73%
Information and Computer Sciences	844,847	9	0.58%
<b>College of Social Sciences</b>	<b>13,811,775</b>	<b>81</b>	<b>5.20%</b>
College of Social Sciences	221,269	5	0.32%
Department of Anthropology	487,407	2	0.13%
Economics	447,115	8	0.51%
Ethnic Studies	10,000	1	0.06%
Geography	472,668	7	0.45%
Political Science	20,742	1	0.06%
Psychology	1,534,183	8	0.51%
School of Communications	36,746	2	0.13%
Social Science Research Institute	5,129,045	39	2.50%
Sociology	35,000	2	0.13%
Urban and Regional Planning	5,417,600	6	0.39%
<b>College of Tropical Agriculture and Human Resources</b>	<b>17,648,266</b>	<b>154</b>	<b>9.88%</b>
Agricultural Diagnostic Service Center	138,512	1	0.06%
Center on the Family	1,200,160	9	0.58%
College of Tropical Agriculture and Human Resources	660,457	6	0.39%
Cooperative Extension	716,464	3	0.19%
Family and Consumer Sciences	141,147	3	0.19%
Hawaii County	1,012,689	15	0.96%
Human Nutrition, Food and Animal Sciences	3,058,494	17	1.09%
Kauai County	13,800	1	0.06%
Maui County	339,729	5	0.32%
Molecular Biosciences and Bioengineering	569,897	4	0.26%
Natural Resources and Environmental Mgt (NREM)	2,085,839	24	1.54%
Oahu County	711,080	5	0.32%
Office of The Assoc Dean for Academic and Student Affairs	2,392,953	6	0.39%
Plant and Environmental Protection Sciences	3,871,180	39	2.50%
Tropical Plant and Soil Science	735,865	16	1.03%
<b>Colleges of Arts and Sciences</b>	<b>18,000</b>	<b>1</b>	<b>0.06%</b>
Colleges of Arts and Sciences	18,000	1	0.06%
<b>Hawai'inuiakea School of Hawaiian Knowledge</b>	<b>2,555,214</b>	<b>5</b>	<b>0.32%</b>
Hawai'inuiakea School of Hawaiian Knowledge	2,555,214	5	0.32%
<b>Institute for Astronomy</b>	<b>15,670,948</b>	<b>65</b>	<b>4.17%</b>
Institute for Astronomy	15,670,948	65	4.17%
<b>John A. Burns School of Medicine</b>	<b>59,950,931</b>	<b>214</b>	<b>13.74%</b>
Associate Dean for Academic Affairs	481,108	4	0.26%
Department of Anatomy, Biochemistry, and Physiology	1,016,683	11	0.71%
Department of Cell and Molecular Biology	3,651,521	12	0.77%
Department of Complementary and Alternative Medicine	2,715,662	12	0.77%
Department of Family Medicine and Community Health	2,555,495	12	0.77%

Department of Geriatric Medicine	916,763	4	0.26%
Department of Medicine	3,019,009	26	1.67%
Department of Native Hawaiian Health	2,627,439	17	1.09%
Department of Obstetrics, Gynecology and Women's Health	5,260,752	11	0.71%
Department of Pediatrics	3,336,392	17	1.09%
Department of Psychiatry	5,473,332	9	0.58%
Department of Surgery	2,001,850	15	0.96%
Department of Tropical Medicine, Medical Micro and Pharm	6,830,451	42	2.70%
Institute for Biogenesis Research	195,492	1	0.06%
John A. Burns School of Medicine	18,489,982	19	1.22%
Native Hawaiian Center of Excellence	1,379,000	2	0.13%
<b>Lyon Arboretum</b>	<b>478,823</b>	<b>8</b>	<b>0.51%</b>
Lyon Arboretum	478,823	8	0.51%
<b>Outreach College</b>	<b>149,263</b>	<b>8</b>	<b>0.51%</b>
Community Programs	87,126	6	0.39%
Outreach College	62,137	2	0.13%
<b>School of Architecture</b>	<b>150,175</b>	<b>1</b>	<b>0.06%</b>
School of Architecture	150,175	1	0.06%
<b>School of Nursing and Dental Hygiene</b>	<b>2,407,654</b>	<b>13</b>	<b>0.83%</b>
Department of Nursing	2,298,715	10	0.64%
School of Nursing and Dental Hygiene	108,939	3	0.19%
<b>School of Ocean and Earth Science and Technology</b>	<b>93,144,266</b>	<b>394</b>	<b>25.29%</b>
Center for Microbial Oceanography, Research and Edu (C-MORE)	4,053,028	10	0.64%
Department of Atmospheric Sciences	1,194,182	9	0.58%
Department of Geology and Geophysics	2,566,204	25	1.60%
Department of Ocean and Resources Engineering	1,660,013	13	0.83%
Department of Oceanography	11,074,819	54	3.47%
Hawaii Institute of Geophysics and Planetology (HIGP)	10,172,044	85	5.46%
Hawaii Institute of Marine Biology (HIMB)	3,651,711	35	2.25%
Hawaii Natural Energy Institute (HNEI)	11,560,139	13	0.83%
International Pacific Research Center (IPRC)	2,373,040	16	1.03%
Joint Institute for Marine and Atmospheric Research (JIMAR)	22,402,008	62	3.98%
Pacific Biosciences Research Center	4,919,043	33	2.12%
School of Ocean and Earth Science and Technology	11,774,057	16	1.03%
Sea Grant College Program	4,995,218	22	1.41%
University Marine Center/Ship Operations	748,760	1	0.06%
<b>School of Pacific and Asian Studies</b>	<b>2,011,240</b>	<b>14</b>	<b>0.90%</b>
Center for Chinese Studies	221,202	2	0.13%
Center for Japanese Studies	571,350	2	0.13%
Center for Korean Studies	233,273	5	0.32%
Center for Pacific Islands Studies	405,000	2	0.13%

Center for Southeast Asian Studies	579,900	2	0.13%
School of Pacific and Asian Studies	515	1	0.06%
<b>School of Social Work</b>	<b>7,024,273</b>	<b>48</b>	<b>3.08%</b>
Center on Aging	165,071	3	0.19%
Dept of Public Health Sciences and Epidemiology	571,102	8	0.51%
Office of Public Health Studies	5,105,250	24	1.54%
School of Social Work	1,182,850	13	0.83%
<b>University of Hawaii Cancer Center</b>	<b>20,857,092</b>	<b>80</b>	<b>5.13%</b>
Cancer Biology	1,337,928	10	0.64%
Cancer Epidemiology	9,954,190	34	2.18%
Cancer Prevention in the Pacific	665,218	4	0.26%
Translational and Clinical Research	3,518,671	21	1.35%
University of Hawaii Cancer Center	5,381,085	11	0.71%
<b>Vice Chancellor, Academic Affairs</b>	<b>1,408,738</b>	<b>11</b>	<b>0.71%</b>
Graduate Education	695,000	1	0.06%
International & Exch Prog	56,655	1	0.06%
Library	106,081	5	0.32%
Service Learning	47,147	2	0.13%
UH Press	100,000	1	0.06%
Undergraduate Education	403,855	1	0.06%
<b>Vice Chancellor, Research</b>	<b>74,853</b>	<b>3</b>	<b>0.19%</b>
Animal and Veterinary Services Program	49,900	1	0.06%
Vice Chancellor, Research	24,953	2	0.13%
<b>Vice Chancellor, Students</b>	<b>4,622,694</b>	<b>16</b>	<b>1.03%</b>
Health & Wellness	45,000	2	0.13%
Student Equity Excel & Diversity	2,752,843	10	0.64%
Vice Chancellor, Students	1,074,955	1	0.06%
Women's Center	749,896	3	0.19%
<b>Water Resources Research Center</b>	<b>3,989,558</b>	<b>12</b>	<b>0.77%</b>
Water Resources Research Center	3,989,558	12	0.77%
<b>William S. Richardson School of Law</b>	<b>2,540,068</b>	<b>43</b>	<b>2.76%</b>
William S. Richardson School of Law	2,540,068	43	2.76%
<b>Grand Total</b>	<b>301,095,266</b>	<b>1,558</b>	<b>100.00%</b>

**Figure 9b: UH Hilo - Contract and Grant Awards Summary  
by College/Department**

<b>UH Hilo College/Department</b>	<b>Award Amount</b>	<b>Award Count</b>	<b>% of Total</b>
<b>Chancellor, UH Hilo</b>	<b>1,958,215</b>	<b>5</b>	<b>3.76%</b>
Chancellor, UH Hilo	1,958,215	5	3.76%
<b>College of Agriculture, Forestry and Natural Resource Mgt</b>	<b>1,077,332</b>	<b>16</b>	<b>12.03%</b>
College of Agriculture, Forestry and Natural Resource Mgt	524,389	8	6.02%
Pacific Aquaculture and Coastal Resources Ctr	552,943	8	6.02%
<b>College of Arts and Sciences</b>	<b>2,928,225</b>	<b>32</b>	<b>24.06%</b>
Anthropology	469,881	2	1.50%
Art	10,000	1	0.75%
Biology	478,623	6	4.51%
Chemistry	37,500	2	1.50%
College of Arts and Sciences	300,000	1	0.75%
Geography	272,296	4	3.01%
Geology-Geophysics	6,768	1	0.75%
Marine Science	24,373	1	0.75%
Mathematics	7,000	1	0.75%
Natural Sciences Division	947,972	8	6.02%
Physics and Astronomy	223,812	3	2.26%
Social Sciences Division	150,000	2	1.50%
<b>College of Business and Economics</b>	<b>120,000</b>	<b>1</b>	<b>0.75%</b>
College of Business and Economics	120,000	1	0.75%
<b>College of Continuing Education and Community Svc</b>	<b>31,750</b>	<b>2</b>	<b>1.50%</b>
College of Continuing Education and Community Svc	31,750	2	1.50%
<b>College of Pharmacy</b>	<b>196,873</b>	<b>8</b>	<b>6.02%</b>
College of Pharmacy	44,290	3	2.26%
Pharmaceutical Sciences	82,400	3	2.26%
Pharmacy Practice	70,183	2	1.50%
<b>Hawaii Small Business Development Center</b>	<b>1,142,235</b>	<b>7</b>	<b>5.26%</b>
Hawaii Small Business Development Center	1,142,235	7	5.26%
<b>Imiloa Astronomy Center Of Hawaii</b>	<b>832,854</b>	<b>9</b>	<b>6.77%</b>
Imiloa Astronomy Center Of Hawaii	832,854	9	6.77%
<b>Ka Haka'Ula O Ke'Elitolani-UHH</b>	<b>1,774,041</b>	<b>7</b>	<b>5.26%</b>
Hale Kuamo'o Center	667,437	3	2.26%
Ka Haka'Ula O Ke'Elitolani-UHH	1,106,604	4	3.01%
<b>Vice Chancellor for Academic Affairs (UH Hilo)</b>	<b>57,000</b>	<b>1</b>	<b>0.75%</b>
Vice Chancellor for Academic Affairs (UH Hilo)	57,000	1	0.75%
<b>Vice Chancellor for Administrative Affairs</b>	<b>2,250</b>	<b>1</b>	<b>0.75%</b>
Vice Chancellor for Administrative Affairs	2,250	1	0.75%

<b>Vice Chancellor for Research</b>	<b>1,482,154</b>	<b>32</b>	<b>24.06%</b>
Vice Chancellor for Research	1,482,154	32	24.06%
<b>Vice Chancellor for Student Affairs</b>	<b>1,347,664</b>	<b>12</b>	<b>9.02%</b>
Center For Gifted And Talented Native Hawaiian Children	44,800	1	0.75%
Vice Chancellor for Student Affairs	1,302,864	11	8.27%
<b>Grand Total</b>	<b>12,950,593</b>	<b>133</b>	<b>100.00%</b>

**Chart 10: Total Contract and Grant Expenditures by Source of Funds  
FYs 2017 and 2018**  
(in millions)

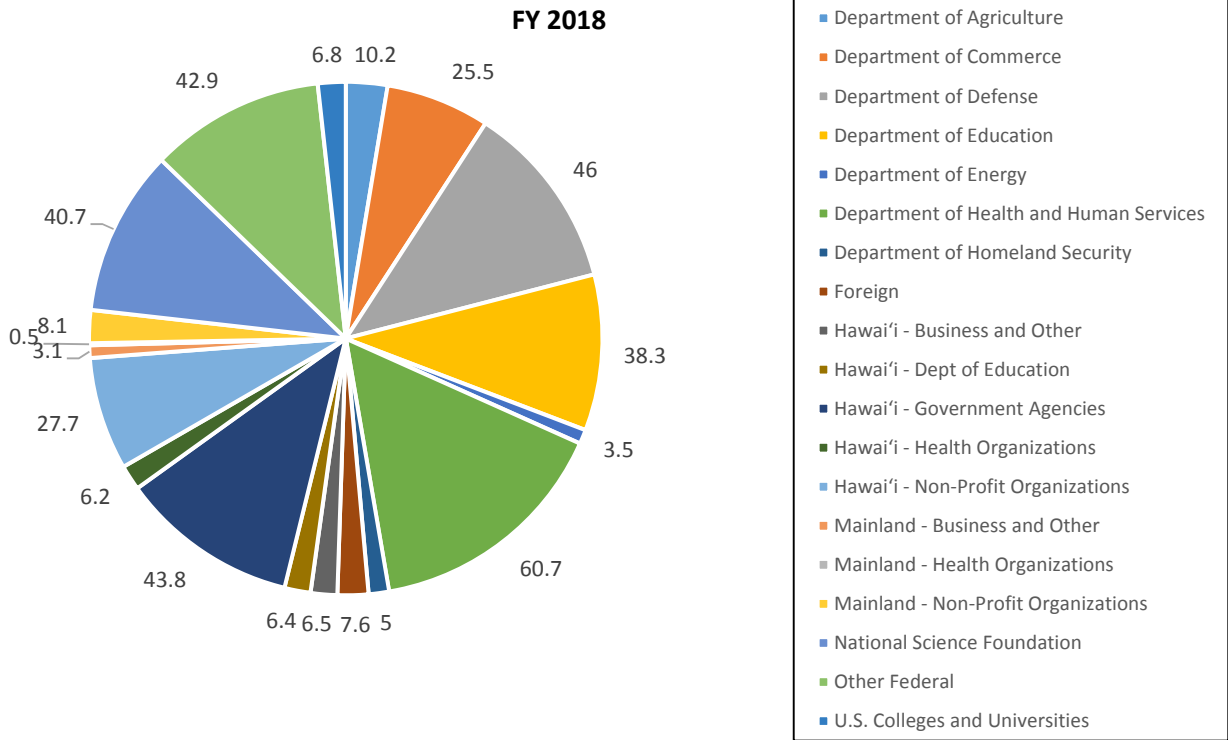
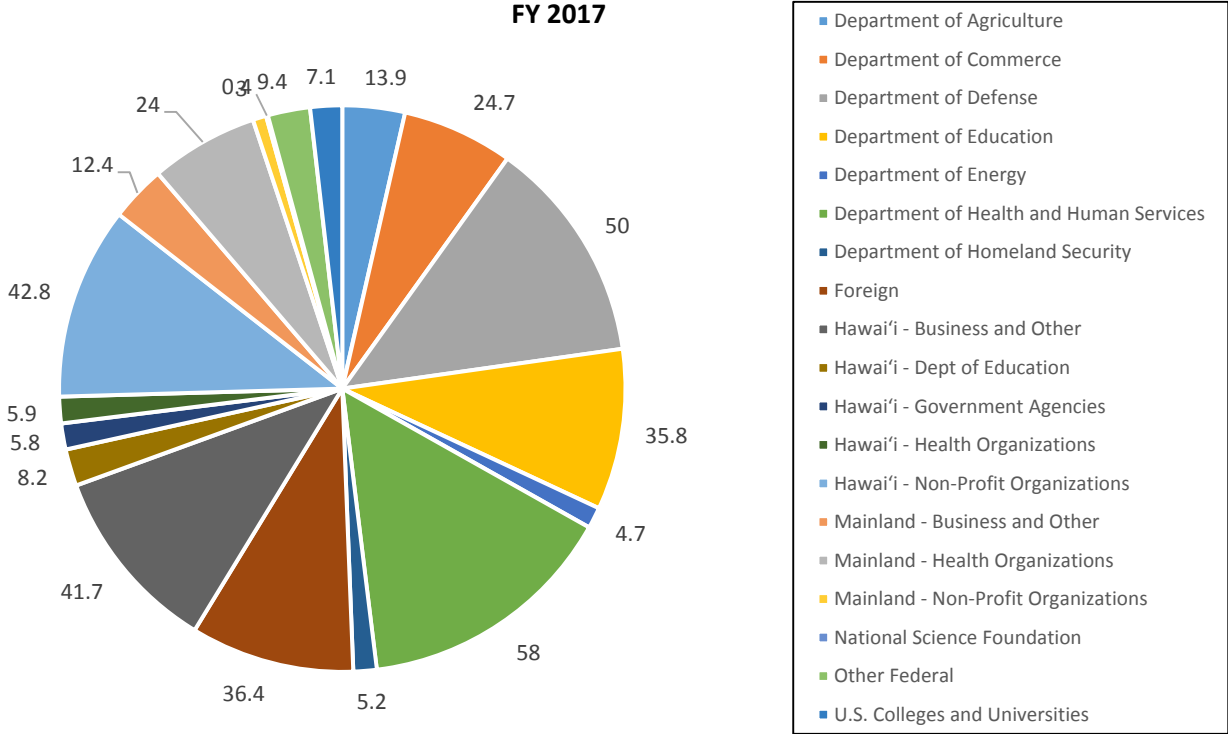



**Figure 10: Total Contract and Grant Expenditures by Source of Funds  
FYs 2017 and 2018**

Source of Funds	FY 2017	% of Total	FY 2018	% of Total
Department of Agriculture	\$ 13,894,152.59	4%	\$ 10,165,191.03	3%
Department of Commerce	\$ 24,659,352.27	6%	\$ 25,497,165.29	7%
Department of Defense	\$ 50,008,941.19	13%	\$ 45,984,233.40	12%
Department of Education	\$ 35,796,701.94	9%	\$ 38,332,548.70	10%
Department of Energy	\$ 4,677,877.19	1%	\$ 3,475,577.70	1%
Department of Health and Human Services	\$ 58,042,845.34	15%	\$ 60,674,403.34	16%
Department of Homeland Security	\$ 5,204,186.19	1%	\$ 5,000,906.79	1%
National Science Foundation	\$ 36,396,678.70	9%	\$ 40,678,267.03	10%
Other Federal	\$ 41,698,817.70	11%	\$ 42,895,276.00	11%
Foreign	\$ 8,239,015.47	2%	\$ 7,553,867.42	2%
Hawai'i - Business and Other	\$ 5,819,879.13	1%	\$ 6,455,302.65	2%
Hawai'i - Dept of Education	\$ 5,945,201.69	2%	\$ 6,448,338.07	2%
Hawai'i - Government Agencies	\$ 42,838,587.73	11%	\$ 43,833,291.71	11%
Hawai'i - Health Organizations	\$ 12,441,344.57	3%	\$ 6,174,202.40	2%
Hawai'i - Non-Profit Organizations	\$ 24,022,647.37	6%	\$ 27,720,163.41	7%
Mainland - Business and Other	\$ 3,006,224.49	1%	\$ 3,066,627.13	1%
Mainland - Health Organizations	\$ 394,630.22	0%	\$ 491,356.48	0%
Mainland - Non-Profit Organizations	\$ 9,438,769.26	2%	\$ 8,100,926.19	2%
U.S. Colleges and Universities	\$ 7,050,394.35	2%	\$ 6,774,354.49	2%
<b>GRAND TOTAL</b>	<b>\$ 389,576,247.39</b>	<b>100%</b>	<b>\$ 389,321,999.23</b>	<b>100%</b>

**Summary:**

The largest source is the Department of Health and Human Services (16% of the total), followed by the Department of Defense (12% of the total).

**Chart 11: Total Contract and Grant Expenditures by Program Type and Source of Funds**  
(in millions)

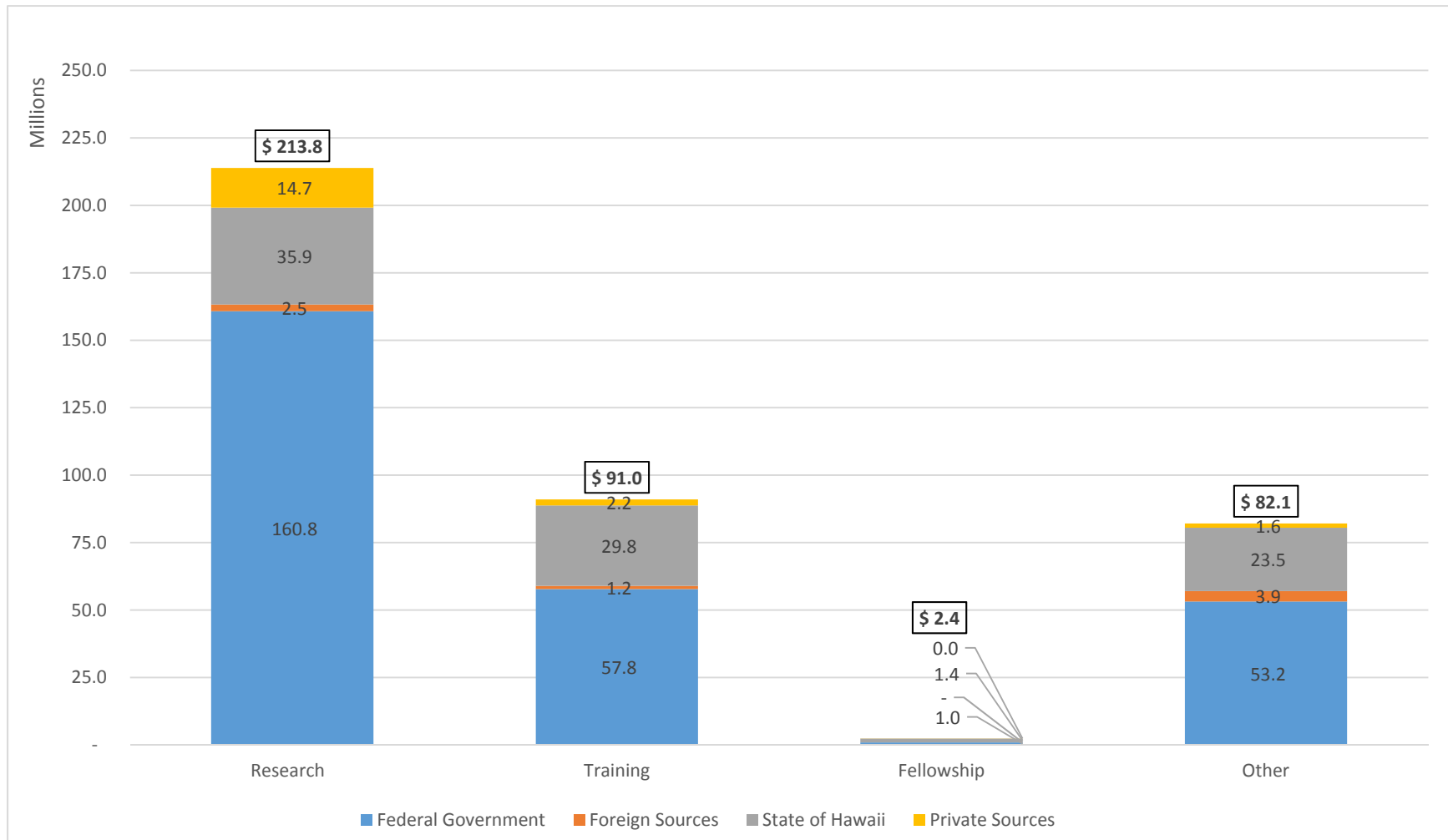

**Figure 11: Total Contract and Grant Expenditures by Program Type and Source of Funds**

Source of Funding		Research	Training	Fellowship	Other	Total	% of total
Federal Government	Department of Agriculture	6,946,741	2,855,172	-	363,278	10,165,191	3%
	Department of Commerce	20,113,870	574,522	181,062	4,627,711	25,497,165	7%
	Department of Defense - Air Force	8,725,389	-	-	-	8,725,389	2%
	Department of Defense - Army	2,520,337	196,440	-	740,173	3,456,950	1%
	Department of Defense - Navy	18,158,123	123,131	-	2,623,514	20,904,767	5%
	Department of Education	713,024	27,259,779	-	10,359,746	38,332,549	10%
	Department of Energy	3,385,062	90,516	-	-	3,475,578	1%
	Department of Health and Human Services	46,209,105	10,003,059	37,457	4,424,782	60,674,403	16%
	Department of Homeland Security	-	5,000,907	-	-	5,000,907	1%
	Department of Interior	7,254,695	16,526	-	953,452	8,224,673	2%
	Department of State	1,308,437	356,423	-	-	1,664,860	0%
	Department of Transportation	148,083	10,076	-	217,596	375,754	0%
	Department of Veterans Affairs	-	98,218	-	-	98,218	0%
	Environmental Protection Agency	94,819	10,908	-	88,137	193,863	0%
	National Aeronautics and Space Administration	10,654,610	1,050,779	9,464	11,505,678	23,220,531	6%
	National Science Foundation	22,376,809	5,919,965	724,630	11,656,864	40,678,267	10%
Other Department of Defense	11,850,965	307,191	-	738,972	12,897,128	3%	
Other Federal	320,930	3,923,672	-	4,872,775	9,117,377	2%	
<b>Federal Government Total</b>		<b>160,780,996</b>	<b>57,797,283</b>	<b>952,612</b>	<b>53,172,678</b>	<b>272,703,569</b>	<b>70%</b>
Foreign Sources	Foreign Sources	2,476,773	1,190,923	-	3,886,172	7,553,867	2%
<b>Foreign Sources Total</b>		<b>2,476,773</b>	<b>1,190,923</b>	<b>-</b>	<b>3,886,172</b>	<b>7,553,867</b>	<b>2%</b>
State of Hawaii	Hawai'i - Business and Other	1,673,978	3,124,347	1,190,031	466,946	6,455,303	2%
	Hawai'i - Department of Education	32,718	2,085,041	-	4,330,579	6,448,338	2%
	Hawai'i - Government Agencies	23,644,151	7,684,431	-	12,504,710	43,833,292	11%
	Hawai'i - Health Organizations	860,139	5,063,844	-	250,220	6,174,202	2%
	Hawai'i - Non- Profit Organizations	9,692,226	11,850,165	252,697	5,925,074	27,720,163	7%
<b>State of Hawaii Total</b>		<b>35,903,212</b>	<b>29,807,828</b>	<b>1,442,728</b>	<b>23,477,529</b>	<b>90,631,298</b>	<b>23%</b>
Private Sources	Mainland - Business and Other	2,271,697	159,264	-	635,666	3,066,627	1%
	Mainland - Health Organizations	340,014	97,405	-	53,937	491,356	0%
	Mainland - Non-Profit Organizations	6,583,186	1,228,803	2,376	286,561	8,100,926	2%
	U.S. Colleges and Universities	5,467,484	707,513	-	599,358	6,774,354	2%
<b>Private Sources Total</b>		<b>14,662,382</b>	<b>2,192,985</b>	<b>2,376</b>	<b>1,575,522</b>	<b>18,433,264</b>	<b>5%</b>
<b>Grand Total</b>		<b>213,823,363</b>	<b>90,989,018</b>	<b>2,397,717</b>	<b>82,111,901</b>	<b>389,321,999</b>	<b>100%</b>

**Chart 12: Total FTE Paid from Contract and Grant Funds  
FYs 2017 and 2018**

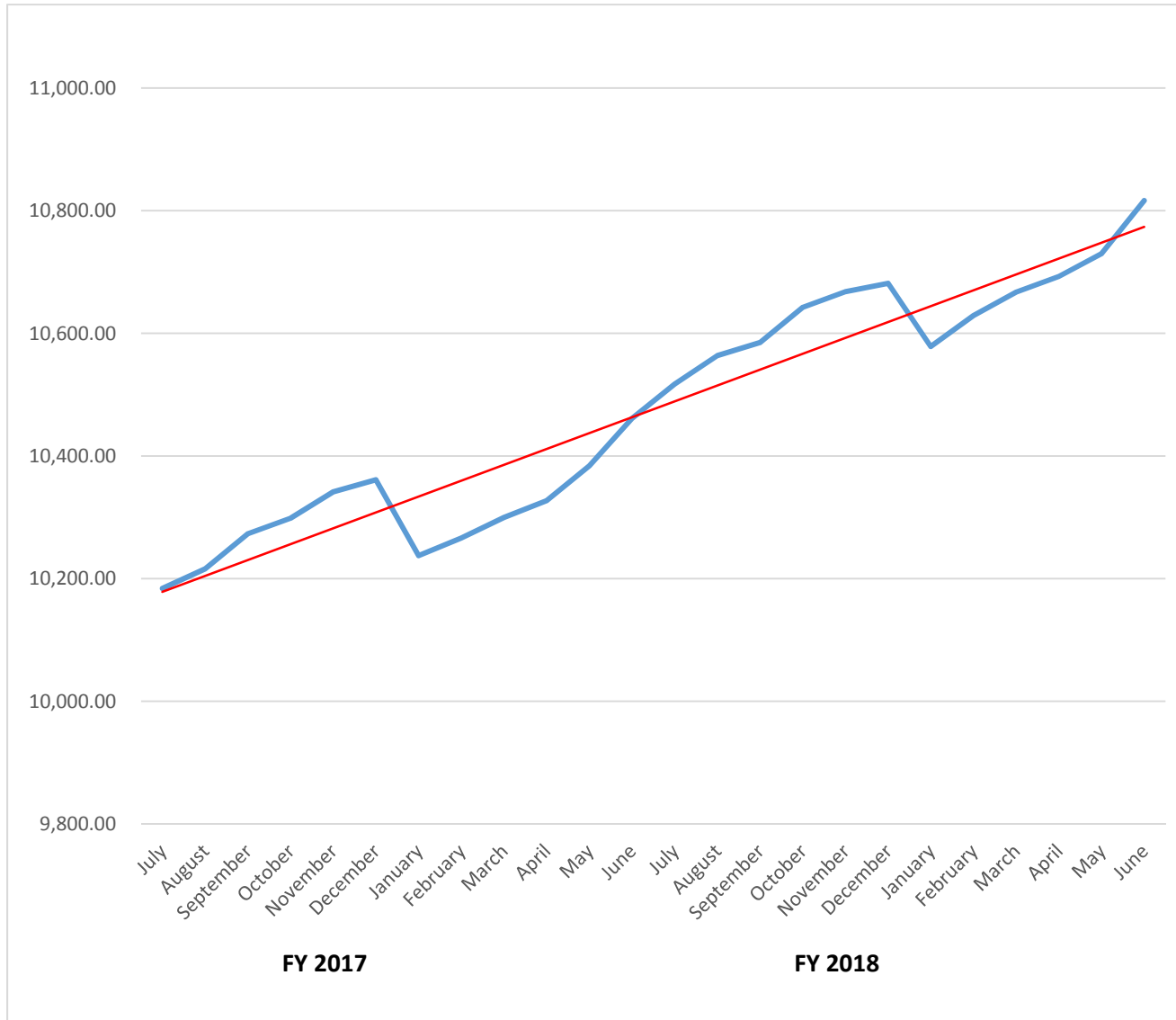
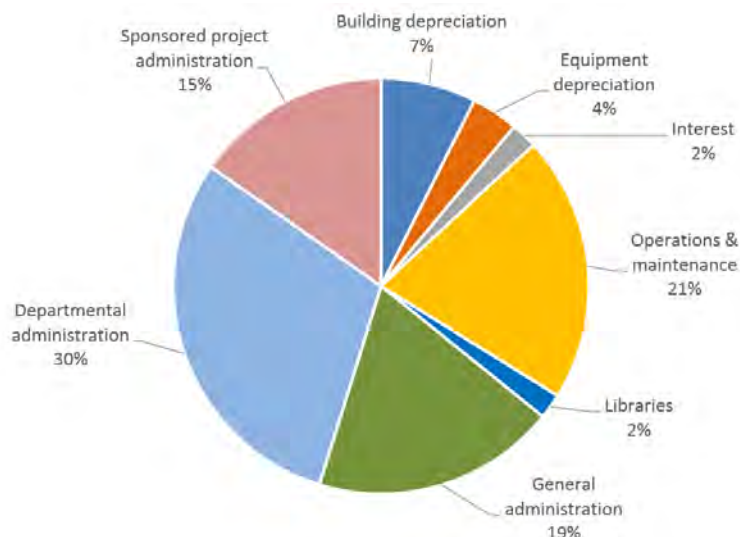

**Figure 12: Total FTE Paid from Contract and Grant Funds  
FYs 2017 and 2018**

<b>Month</b>	<b>Year to Date FY 17</b>	<b>Year to Date FY 18</b>
July	10,184.05	10,517.38
August	10,215.86	10,563.66
September	10,273.13	10,584.97
<b>Monthly Average Q1</b>	<b>10,224.35</b>	<b>10,555.34</b>
October	10,298.59	10,642.38
November	10,341.53	10,668.01
December	10,361.18	10,681.43
<b>Monthly Average Q2</b>	<b>10,333.77</b>	<b>10,663.94</b>
January	10,237.63	10,578.49
February	10,266.06	10,628.99
March	10,299.64	10,667.28
<b>Monthly Average Q3</b>	<b>10,267.77</b>	<b>10,624.92</b>
April	10,327.07	10,692.88
May	10,384.08	10,729.86
June	10,461.06	10,816.58
<b>Monthly Average Q4</b>	<b>10,390.74</b>	<b>10,746.44</b>
<b>Monthly Average FY</b>	<b>10,304.16</b>	<b>10,647.66</b>
<b>Change (Number)</b>		<b>343.50</b>
<b>Change (Percent)</b>		<b>3.33%</b>

**Note: FTE includes University of Hawai'i and Research Corporation of the University of Hawai'i**

**Chart 13: Breakdown of Facilities and Administrative Costs by Major Category FY 2016 Base Year**



In a typical year, roughly a third of the University of Hawai‘i’s overhead for sponsored projects maintains its facilities for supporting sponsored activity and roughly two-thirds supports central and departmental sponsored activity administration. About 30% of the total total facilities & administrative costs (F&A) represents administration of sponsored activity with schools, colleges, and research units. These funds are used by deans and directors to support fiscal administrators and other staff who assist faculty with sponsored activity – including grant proposal preparation and budget management.

The pie chart represents the proportion of actual overhead costs during the UH’s last F&A base year (FY 2016). Thirty-four percent of the F&A funds represented costs of providing centralized research administration and compliance services, such as research accounting and analysis, human resources, payroll, purchasing, Office of Research Services, Human Studies, Institutional Animal Care, and Research Corporation of the University of Hawai‘i. Of the 36% spent on facilities, about 58% was spent on operations and maintenance of existing sponsored activity space, including paying for such costs as utilities, hazardous materials disposal, and janitorial services. The remainder paid for repairs and renovations of buildings, ‘debt service’ (interest), major equipment replacement, and support for the libraries.

The University of Hawai‘i received approximately \$49.9 million in F&A cost reimbursements in FY 2018. Each campus received 75% of the recovered F&A generated by its faculty through the Research and Training Revolving Fund (RTRF) allocation. The PI’s college or research unit at the University of Hawai‘i at Mānoa generally receives 50% of the recovered F&A costs. These funds are used at the discretion of the chancellors, deans and directors to support research and training in their units.

F&A cost reimbursements are related to UH expenditures. When the UH develops its biennial budget, it starts with an estimate of the total revenues available for that biennium, including state funding, tuition, F&A cost reimbursement, and interest and investment income. All these funding sources are combined to pay for the UH’s operating expenses, including F&A costs related to research and other sponsored agreements.

**Chart 14: Total Royalties Received from University Patents**  
**FYs 2014 to 2018**  
(in thousands)

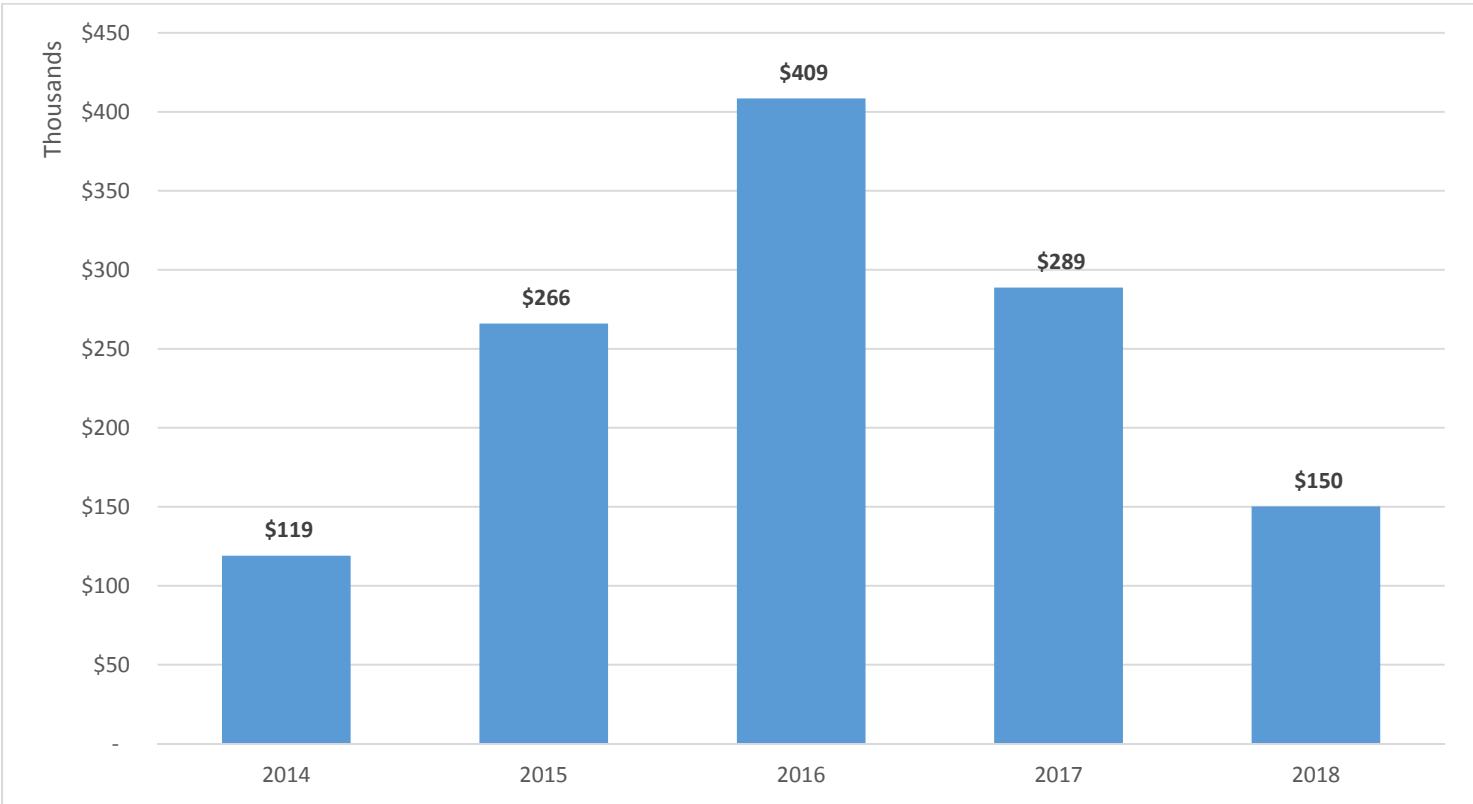

**Figure 13: Total Royalties Received from University Patents  
FYs 2014 to 2018**

<b>Fiscal Year</b>	<b>Royalties</b>
2014	\$ 118,991
2015	\$ 265,974
2016	\$ 408,513
2017	\$ 288,752
2018	\$ 150,172
<b>Total Royalties</b>	<b>\$1,232,402</b>



## Appendix 1: Extramural Award Sponsors

### **FEDERAL**

#### **DA-DEPT OF AGRICULTURE**

AGRICULTURE, DEPT - ANIMAL AND PLANT HEALTH INSPECTION SERVICE  
AGRICULTURE, DEPT, FOREST SVC-FED  
AGRICULTURE, DEPT-AGRI MARKETING SVC-FED  
AGRICULTURE, DEPT-AGRI RSCH SVC-FED  
AGRICULTURE, DEPT-FED  
AGRICULTURE, DEPT-FOREIGN AGRICULTURAL SERVICE  
AGRICULTURE, DEPT-NATL INS FOOD AND AGRICULTURE

#### **DEPT OF STATE**

STATE, DEPT-US AGENCY INTL DEV-FED USAID

#### **DHHS-DEPT OF HEALTH AND HUMAN SERVICES**

HEALTH & HUMAN SVC, DEPT-ADMIN FOR COMM LIVING  
HEALTH & HUMAN SVC, DEPT-CDC-CHRONIC DISEASE PREVENTION & HEALTH PROMO  
HEALTH & HUMAN SVC, DEPT-CTR DIS CTRL-FED  
HEALTH & HUMAN SVC, DEPT-FED  
HEALTH & HUMAN SVC, DEPT-HRSA-FED  
HEALTH & HUMAN SVC, DEPT-HRSA-FED ADV NURSE ED PGM  
HEALTH & HUMAN SVC, DEPT-HRSA-FED BUR OF HLTH PROF  
HEALTH & HUMAN SVC, DEPT-HRSA-FED MATERNAL & CHILD HLTH  
HEALTH & HUMAN SVC, DEPT-HRSA-FED OFC RURAL HEALTH POL  
HEALTH & HUMAN SVC, DEPT-NIH-FED  
HEALTH & HUMAN SVC, DEPT-NIH-FED NATL CANCER INST  
HEALTH & HUMAN SVC, DEPT-NIH-FED NATL HEART LUNG & BLD INST  
HEALTH & HUMAN SVC, DEPT-NIH-FED NATL INST MIN HLTH & DISP  
HEALTH & HUMAN SVC, DEPT-NIH-FED NTL INST ALLERGY/INF DIS  
HEALTH & HUMAN SVC, DEPT-NIH-FED NTL INST DIAB DIG KIDN DIS  
HEALTH & HUMAN SVC, DEPT-NIH-FED NTL INST DRUG ABUSE  
HEALTH & HUMAN SVC, DEPT-NIH-FED NTL INST ENV HLTH SCI  
HEALTH & HUMAN SVC, DEPT-NIH-FED NTL INST GEN MED SCI

HEALTH & HUMAN SVC, DEPT-NIH-FED NTL INST MENTAL HLTH  
HEALTH & HUMAN SVC, DEPT-NIH-FED NTL LIBRARY OF MED  
HEALTH & HUMAN SVC, DEPT-NIH-FED OFFICE OF DIRECTOR  
HEALTH & HUMAN SVC, DEPT-NIH-FOGARTY INTERNATIONAL CTR.  
HEALTH & HUMAN SVC, DEPT-SUB ABUSE/MNTL HLTH SVC-FED  
HEALTH & HUMAN SVC,DEPT-NIH-FED NTL INST CHLD HLTH&HUM DEV  
HEALTH&HUMAN SVC,DEPT-NIH-FED NTL INST NEURO DIS&STROKE

#### **DOC-DEPT OF COMMERCE**

COMMERCE, DEPT-ECONOMIC DEV ADM-FED  
COMMERCE, DEPT-MINORITY BUSN DEV AGENCY-FED  
COMMERCE, DEPT-NATIONL INST STANDARDS &TECH-FED  
COMMERCE, DEPT-NATL NOAA-FED  
COMMERCE, DEPT-NATL NOAA-FED NATL OCEAN SVC  
COMMERCE, DEPT-NATL NOAA-FED NATL WEATHER SVC  
COMMERCE, DEPT-NATL NOAA-FED SEA GRANT COLL PGM  
COMMERCE, DEPT-NOAA/NATL MARINE FISHERIES SVC

#### **DOD-DEPARTMENT OF DEFENSE**

DEFENSE, DEPT- US ARMY CORPS OF ENGINEERS  
DEFENSE, DEPT. - U.S. ARMY RESEARCH OFFICE  
DEFENSE, DEPT-AIR FORCE  
DEFENSE, DEPT-AIR FORCE OFC OF SCI RSCH  
DEFENSE, DEPT-AIR FORCE RESEARCH LABORATORY  
DEFENSE, DEPT-ARMY  
DEFENSE, DEPT-ARMY MED RSCH ACQSTN (USAMRAA)  
DEFENSE, DEPT-ARMY RESEARCH LABORATORY  
DEFENSE, DEPT-DEPUTY UNDR SECRETARY OF DEF  
DEFENSE, DEPT-NATIONAL SECURITY AGY  
DEFENSE, DEPT-NAVY  
DEFENSE, DEPT-NAVY NAVAL FAC ENGRG COMMAND  
DEFENSE, DEPT-NAVY NAVAL RSCH LAB  
DEFENSE, DEPT-NAVY OFC OF NAVAL RSCH  
DEFENSE, DEPT-NAVY SPACE & NAVAL WARFARE SYS CTR PACIFIC  
DEFENSE, DEPT-NAVY US NAVAL OBSERVATORY

DEFENSE, DEPT-WASHINGTON HEADQUARTERS SVCS

**DOE-DEPT OF ENERGY**

ENERGY, DEPT

ENERGY, DEPT. OF - BASIC ENERGY SCIENCES

**DOI-DEPT OF INTERIOR**

INTERIOR, DEPT-BUREAU LAND MGMT-FED

INTERIOR, DEPT-FED OFC OF INSULAR AFFAIRS

INTERIOR, DEPT-FISH & WILDLIFE SVC

INTERIOR, DEPT-NATIONAL PARK SVC

INTERIOR, DEPT-UNITED STATES GEO SURVEY

**DOT-DEPT OF TRANSPORTATION**

TRANSPORTATION, DEPT-FED HWY AD-FED

TRANSPORTATION, DEPT-FED-FED AVIATION ADMIN

**ED-DEPT OF EDUCATION**

EDUCATION, DEPT-FED

EDUCATION, DEPT-FED OFC OF POSTSEC ED

EDUCATION, DEPT-FED OFC OF SPECIAL ED & REHAB SVCS

EDUCATION, DEPT-FED REHAB SVCS ADMIN

EDUCATION, DEPT-FED STUDENT SUPP SVCS PGM

EDUCATION, DEPT-FED TALENT SEARCH PGM

**NATIONAL AERONAUTICS AND SPACE ADMINISTRATION**

NATIONAL AERONAUT & SPACE ADM

NATL AERONAUTICS & SPACE ADM-AMES RESEARCH CTR

NATL AERONAUTICS & SPACE ADM-GODDARD SPACE

FLIGHT CTR

**NATIONAL SCIENCE FOUNDATION**

NATIONAL SCIENCE FOUNDATION

**OTHER FEDERAL AGENCIES**

HOMELAND SECURITY, DEPT-AMERICAN SAMOA

HOMELAND SECURITY, DEPT-FEMA

NATIONAL FOUNDATION ART & HUMAN-INST MUS & LIBR  
SVCS

NATL ENDOWMENT FOR THE HUMANITIES

PEACE CORPS

SMALL BUSINESS ADMINISTRATION

SOCIAL SECURITY ADMINISTRATION

VETERANS AFFAIRS, DEPT-FED

**NON-FEDERAL**

**FOREIGN**

GUAM, GOVERNMENT - GUAM HOMELAND SECURITY

PACIFIC YOUTH AND COMMUNITY DEVELOPMENT

AB AGRI LIMITED

ACADEMY KOREAN STUDIES

AICHI UNIVERSITY

AMERICAN SAMOA COMMUNITY CANCER COALITION

AMERICAN SAMOA, GOVERNMENT

AMERICAN SAMOA, GOVERNMENT- DEPARTMENT OF  
EDUCATION

AOYAMA GAKUIN UNIVERSITY

BERMUDA INSTITUE OF OCEAN SCIENCES, INC.

CENTRE INTEGRE UNIVERSITAIRE DE SANTE ET DE  
SERVICES SOCIAUX

CHIANG CHING-KUO FOUNDATION

CHUO UNIVERSITY

COMMONWEALTH OF NO MARIANA ISLANDS

DAIICHI SANKYO, INC.

ENVRIPLUS

FEDERATED STATES MICRONESIA

FUKADA SALVAGE AND MARINE WORKS COMPANY, LTD.

GUAM, GOVERNMENT - PUBLIC HEALTH AND SOCIAL  
SERVICES

HELMHOLTZ CENTRE FOR ENVIRONMENTAL RESEARCH -  
UFZ

INSTITUTE GEOLOGICAL & NUCLEAR SCIENCES (NZ)

INTERNATIONAL INTEGRATED SYSTEMS INC.

JAPAN AGENCY MARINE-EARTH SCIENCE AND  
TECHNOLOGY

KOREA ELECTROTECHNOLOGY RESEARCH INSTITUTE

KOREA FOUNDATION

KOREA INSTITUTE OF OCEAN SCIENCE & TECHNOLOGY

KOREA RESEARCH INSTITUTE OF SHIPS AND OCEAN  
ENGINEERING

KYOTO SEIKA UNIVERSITY

LONDON, UNIVERSITY OF

MARSHALL ISLANDS, COLLEGE OF

MEIJI UNIVERSITY

NATIONAL ASTRONOMICAL OBSV JAPAN

OKINAWA PREFECTURE GOVERNMENT

OKINAWA RESEARCH CENTER ON LONGEVITY SCIENCES

REPUBLIC MARSHALL ISLANDS

REPUBLIC PALAU

RYUKYUS, UNIVERSITY OF

SEOUL NATIONAL UNIVERSITY

SHANGHAI REALGEN BIOTECH

SYSMEX CORPORATION

TECHNICAL UNIVERSITY OF DENMARK

THE GOVERNORS OF THE UNIVERSITY OF ALBERTA  
 TOKYO UNIVERSITY OF SCIENCE  
 UK SEABED RESOURCES LTD  
 VIIV HEALTHCARE  
 WASEDA UNIVERSITY  
**HAWAII- BUSINESS AND OTHER**  
 AHA PUNANA LEO INC  
 ALU LIKE INC  
 AQUAFEED.COM, LLC  
 BISHOP MUSEUM  
 EAST WEST CENTER  
 GARDEN ISLE RESRCE CONSERV & DEVELOPMENT, INC.  
 HAWAII COUNCIL FOR THE HUMANITIES  
 HAWAIIAN ELECTRIC COMPANY  
 HAWAIIAN SHELLFISH, LLC  
 HO'OKIPAIPAI LLC  
 IOLANI SCHOOL  
 JUN INNOVATIONS  
 KAMEHAMEHA SCHOOLS  
 KAUPO RANCH, LTD.  
 KE KULA 'O NAWAHIOKALANI'OPU'U IKI PUBLIC CHARTER  
 SCHOOL  
 KOLOHALA HOLDINGS LLP  
 LE JARDIN ACADEMY  
 MAKAI OCEAN ENGINEERING INC  
 MALAMA HONUA PUBLIC CHARTER SCHOOL  
 MALAMA KAHALAWAI INC  
 NALU SCIENTIFIC, LLC  
 NAVATEK LTD  
 'OHU'OHU KO'OLAU INC  
 PACIFIC BIODIESEL  
 PACIFIC RADIATION ONCOLOGY INC  
 SPECTRUM PHOTONICS, INC  
 THE KOHALA CENTER  
 TOWILL, R.M. CORPORATION  
 ULUPALAKUA RANCH  
 ULUPONO INITIATIVE  
 VERNON OI  
**HAWAII- DEPT OF EDUCATION**  
 EDUCATION, DEPT-HI  
 EDUCATION, DEPT-HI-HI CHILD NUTRITION PRGMS  
 STATE PUBLIC CHARTER SCHOOL COMMISSION

**HAWAII- GOVERNMENT AGENCIES**  
 HEALTH, DEPT-HI OFFICE OF ENVIRONMENTAL QUALITY  
 CONTROL  
 LAND & NATURAL RES, DPT (DLNR)-COMMISSION ON  
 WATER RESOURCE MANAGEMENT  
 AGRICULTURE, DEPT-AGRIB DEV CORP-HI  
 AGRICULTURE, DEPT-HI  
 BUSINESS, ECON DEV & TOUR, DPT  
 BUSINESS, ECONOMIC DEV&TOUR-HI STATE ENERGY  
 OFFICE  
 CITY & COUNTY HONOLULU  
 CITY & COUNTY HONOLULU DEPT OF PARKS & REC  
 CITY AND COUNTY HONOLULU DEPARTMENT OF  
 ENVIRONMENTAL SERVICES  
 COUNTY HAWAII DEPT OF RESEARCH AND DEVELOPMENT  
 COUNTY KAUAI  
 COUNTY MAUI DEPARTMENT OF ENVIRONMENTAL  
 MANAGEMENT  
 COUNTY MAUI DEPT OF WATER SUPPLY  
 COUNTY MAUI OFC OF ECON DEVEL  
 COUNTY MAUI PLANNING DEPT  
 COUNTY OF HAWAII DEPARTMENT OF WATER SUPPLY  
 DEFENSE, DEPT-HI - HI ARMY NATL GUARD  
 DEFENSE, DEPT-HI-HAWAII EMERGENCY MGMT AGENCY  
 HAWAII STATE FOUNDATION ON CULTURE AND THE ARTS  
 HAWAII STRATEGIC DEVELOPMENT CORPORATION  
 HAWAII TOURISM AUTHORITY  
 HAWAIIAN AFFAIRS, OFFICE OF  
 HAWAIIAN HOME LANDS, DEPT-HI  
 HEALTH, DEPT-ALCOHOL & DRUG ABUSE DIV-HI  
 HEALTH, DEPT-CHILD/ADOLESC MENTAL HLTH DIV-HI  
 HEALTH, DEPT-CHRONIC DISEASE PREVENTION & HEALTH  
 PROMOTION DIV-HI  
 HEALTH, DEPT-DEVELOPMENTAL DC-HI  
 HEALTH, DEPT-EXEC OFF AGING-HI  
 HEALTH, DEPT-FAMILY HLTH SVC DIV-HI  
 HEALTH, DEPT-HAZARD EVAL & EMERGENCY RESPONSE  
 HEALTH, DEPT-HI  
 HEALTH, DEPT-HI MATERNAL AND CHILD HEALTH BRANCH  
 HEALTH, DEPT-HI SAFE DRINKING WATER BRANCH  
 HEALTH, DEPT-HI-ENVIRONMENTAL HEALTH SERVICES  
 DIVISION  
 HEALTH, DEPT-HI-GENOMICS SECTION  
 HEALTH, DEPT-HI-OFFICE OF LANGUAGE ACCESS

HEALTH, DEPT-MAT & CHILD  
HEALTH, DEPT-OFFICE OF PLANNING, POLICY, AND  
PROGRAM DEV-HI  
HEALTH, DEPT-TOBACCO SETTLEMENT-HI  
HIGH TECHNOLOGY DEVELOPMENT CORPORATION-HI  
HUMAN SERVICES, DEPT-DIVISION OF VOCATIONAL  
REHABILITATION  
HUMAN SERVICES, DEPT-HI  
HUMAN SERVICES, DEPT-HI BENEFITS, EMPLOYMENT &  
SUPPORT SERVICES  
HUMAN SERVICES, DEPT-OYS-HI  
JUDICIARY-HI  
KAHOOLAWE ISLAND RESERVE COMMISSION  
LABOR & INDUSTRIAL RELATION, DPT-HI (DLIR)  
LAND & NATURAL RES, DPT-AQUAT (DLNR)  
LAND & NATURAL RES, DPT-BOATING & OCEAN REC (DLNR)  
LAND & NATURAL RES, DPT-FORST (DLNR)  
LAND & NATURAL RES, DPT-STATE PARKS (DLNR)  
LAND & NATURAL RESOURCES, DEPT (DLNR)  
LAND & NATURAL RESOURCES, DEPT (DLNR) OFC CONS  
COAST LDS  
OFFICE OF ENTERPRISE TECHNOLOGY SERVICES  
PUBLIC SAFETY, DEPT-HI  
TRANSPORTATION, DEPT-HI  
WATER SUPPLY, BOARD OF

**HAWAII- HEALTH ORGANIZATIONS**

CASTLE MEDICAL CENTER  
HAWAII MEDICAL SERVICE ASSOCIATION  
HAWAII MEDICAL SRVC ASSN FOUNDATION  
KALIHI-PALAMA HEALTH CENTER  
KAPIOLANI MED CTR FOR WOMEN & CHILDREN  
KAPIOLANI MEDICAL SPECIALIST  
KUAKINI MEDICAL CENTER  
PACIFIC IN VITRO FERTILIZATION INSTITUTE  
QUEEN'S MEDICAL CENTER  
STRAUB CLINIC & HOSPITAL  
UNIVERSITY CLINICAL EDUCATIONAL & RSCH ASSOC  
(UCERA)

**HAWAII- NON-PROFIT ORGANIZATIONS**

BIG ISLAND RESOURCE CONSERVATION & DEV COUNCIL  
INC.  
CASTLE (HAROLD K L) FOUNDATION  
COALITION DRUG-FREE HAWAII  
CREATE, LLC

GENERAL CONTRACTORS ASSOC HI EDUCATIONAL  
FOUNDATION  
HANALANI SCHOOLS  
HAWAII CANCER CONSORTIUM  
HAWAII CHILDREN'S ACTION NETWORK  
HAWAII COMMUNITY FOUNDATION (HCF)  
HAWAII COMMUNITY FOUNDATION CHILDRENS TRUST  
FUND  
HAWAII COMMUNITY FOUNDATION GEIST FDTN  
HAWAII COMMUNITY FOUNDATION INGBORG VF MCKEE  
FUND  
HAWAII COMMUNITY FOUNDATION MEDICAL RESEARCH  
HAWAII FARM BUREAU FEDERATION  
HAWAII FLORICULTURE AND NURSERY ASSOCIATION  
HAWAII JUSTICE FOUNDATION  
HAWAII PUBLIC HEALTH INSTITUTE  
HAWAII WATER ENVIRONMENT ASSOCIATION  
HAWAIIAN LEGACY FOUNDATION  
INSTITUTE FOR HUMAN SERVICES  
KOKUA KALIHI VALLEY  
KULA NO NA PO`E HAWAII  
MALAMA KAI FOUNDATION  
NATIVE HAWAIIAN EDUCATION COUNCIL  
O'AHU WATERKEEPER  
OCEANIC INSTITUTE-CTR FOR TOP & SUB TROP AQUA  
(CTSA)  
OLELO  
PAC RESOURCES FOR ED & LEARNING (PREL)  
PAC5  
PACIFIC AMERICAN FOUNDATION  
PACIFIC RIM CONSERVATION  
THE CHOW PROJECT  
THE OUTDOOR CIRCLE  
THREE MOUNTAIN ALLIANCE FOUNDATION  
UNIVERSITY HAWAII FOUNDATION  
UNIVERSITY HEALTH PARTNERS  
WAIKIKI BEACH SPECIAL IMPROVEMENT DISTRICT ASSN  
WAIKIKI HEALTH  
YMCA OF HONOLULU  
**MAINLAND- BUSINESS AND OTHER**

ADVAXIS, INC.  
ALTOR BIOSCIENCES  
AMERICA VIEW  
ASSOCIATION OF AMERICAN COLLEGES AND UNIVERSITIES

BATTELLE ENERGY ALLIANCE, LLC  
BLOOD SYSTEMS RESEARCH INSTITUTE  
BROOKHAVEN NATIONAL LABORATORY  
CALIBRE SYSTEMS  
CAMPUS COMPACT NATIONAL CTR COMMUNITY COLLEGES  
CEREGO LLC  
CLARKSON AEROSPACE CORP  
CONTRAMED  
CROP ENHANCEMENT, INC.  
DESERT RESEARCH INSTITUTE  
DOER MARINE  
ENVIRONMENTAL DEFENSE  
ESSENTIAL TEACHING AND LEARNING PD LLC  
EXTENSION FOUNDATION  
FERMI NATIONAL ACCELERATOR LAB  
GENENTECH INC  
GILEAD FOUNDATION - GILEAD SCIENCES INC  
GOODMAN TECHNOLOGIES, LLC  
GYNUITY HEALTH PROJECTS  
ICF INCORPORATED, LLC  
IGNYTA, INC.  
INTERNATIONAL FOUNDATION FOR RESEARCH IN EXPERIMENTAL ECONOMICS  
JET PROPULSION LAB-JPL  
KEVALA ANALYTICS  
LAWRENCE LIVERMORE NATL LAB  
LEIDOS  
LILLY USA, LLC  
LOCKHEED MARTIN CORP SPACE SYSTEMS  
LOUIS BERGER  
MATHNIMBUS, INC.  
NATIONAL GEOGRAPHIC SOCIETY  
NEURALTUS PHARMACEUTICALS, INC.  
NIYAMIT, INC.  
NORTH PACIFIC RESEARCH BOARD  
PREDICTIVE SCIENCE INC.  
Q-PEAK, INC.  
RAIMI & ASSOCIATES, INC.  
SALVATION ARMY  
SANDIA NATIONAL LABORATORIES  
SMITHSONIAN ASTROPHYSICAL OBSERVATORY  
SPACE TELESCOPE SCIENCE INSTITUTE

TAIMED BIOLOGICS USA CORP  
TELEDYNE BROWN ENGINEERING  
TELOMERASE ACTIVATION SCIENCES, INC.  
TRANS ASTRONAUTICA CORP. DBA TRANSASTRA  
VENCORE  
WOODS HOLE OCEANOGRAPHIC INSTITUTION  
WYLE LABORATORIES, INC.

**MAINLAND- HEALTH ORGANIZATIONS**

AMERICAN HEART ASSOCIATION  
AMERICAN PSYCHOLOGICAL ASSOCIATION  
CHILDRENS HOSPITAL LOS ANGELES  
EDUCATIONAL TESTING SERVICE  
HOWARD HUGHES MEDICAL INSTITUTE (HHMI)  
HUTCHINSON (FRED) CANCER RESRCH CTR  
KAISER FOUNDATION RESEARCH INSTITUTE  
RIVERSIDE RESEARCH INSTITUTE

**MAINLAND- NON-PROFIT ORGANIZATIONS**

ALEX'S LEMONADE STAND FOUNDATION  
ALLEN (PAUL G) FAMILY FOUNDATION  
ALLIANCE FOUNDATION TRIALS, LLC  
AMERICAN BIRD CONSERVANCY  
ANDREW W. MELLON FOUNDATION  
ANHEUSER-BUSCH COMPANIES- AH BUSCH FDTN  
ASSN OF PUBLIC & LAND-GRANT UNIVERSITIES  
ASSOCIATION OF UNIVERSITIES FOR RESEARCH IN ASTRONOMY, INC.  
ASSOCIATION UNIVERSITIES RESEARCH IN ASTRONOMY, INC.  
ASSOCIATION UNIVERSITY CENTER DISABILITIES  
BATTELLE MEMORIAL INSTITUTE  
BECKMAN (ARNOLD AND MABEL) FOUNDATION  
BRISTOL-MYERS SQUIBB FOUNDATION  
CADES FOUNDATION (J RUSSELL/CHARLOTTE MCL)  
CALIFORNIA ASSOCIATION RESEARCH IN ASTRONOMY (KECK)  
CARNEGIE INSTITUTE WASHINGTON  
CASEY, ANNIE E., FOUNDATION  
CEDARS-SINAI MEDICAL CENTER  
CHILDREN'S HOSPITAL MEDICAL CENTER  
COMMONWEALTH OF NORTHERN MARIANAS ISLANDS-  
COMMONWEALTH HEALTHCARE CORPORATION  
CONSORTIUM FOR OCEAN LEADERSHIP  
DUKE UNIVERSITY  
EARTH & SPACE RESEARCH

EARTHWATCH  
FACE FOUNDATION  
HENRY M. JACKSON FOUNDATION FOR THE  
ADVANCEMENT OF MILITARY MEDICINE  
INSTITUTE FOR WILDLIFE STUDIES  
INSTITUTE INTERNATIONAL EDUCATION  
INTERNATIONAL FOUNDATION FOR ETHICAL RESEARCH  
JOHNSON (ROBERT WOOD) FOUNDATION  
LINK FOUNDATION  
LOWELL OBSERVATORY  
MD ANDERSON CANCER CENTER  
MOORE (GORDON & BETTY) FOUNDATION  
MOTT (CHARLES STEWART) FOUNDATION  
NATIONAL FISH & WILDLIFE FOUNDATION  
NATIONAL FOUR-H COUNCIL (4-H)  
NATIONAL MARINE SANCTUARY FOUNDATION  
NATIVE AMERICAN INDIGENOUS STUDIES ASSN  
NATURE CONSERVANCY, THE  
NEW ENGLAND FOUNDATION ARTS (NEFA)  
OCEAN FOUNDATION  
OLD DOMINION UNIVERSITY RESEARCH FOUNDATION  
PEW CHARITABLE TRUSTS  
PLANETARY SCIENCE INSTITUTE  
POSNER FOUNDATION OF PITTSBURGH  
RESEARCH FOUNDATION STATE UNIV NY  
SAN JOSE STATE UNIVERSITY RESEARCH FOUNDATION  
SCHMIDT MARINE TECHNOLOGY PARTNERS  
SEATTLE INSTITUTE FOR BIOMEDICAL & CLINICAL  
RESEARCH  
SIMONS FOUNDATION  
SOCIETY FOR CONSERVATION BIOLOGY  
SPENCER FOUNDATION  
ST. BALDRICK'S FOUNDATION  
TMT INTERNATIONAL OBSERVATORY LLC  
UNITED STATES VETERANS INITIATIVE  
UNIVERSITIES SPACE RESEARCH ASSN  
UNIVERSITY CORP ATMOSPHERIC RSCH  
WESTERN STATES ART FEDERATION (WESTAF)  
WISTAR INSTITUTE  
WORLD RESOURCES INSTITUTE  
WORLD WILDLIFE FUND  
**US COLLEGES AND UNIVERSITIES**  
ALASKA FAIRBANKS, UNIVERSITY OF

ARIZONA STATE UNIVERSITY  
ARIZONA, UNIVERSITY OF  
ARKANSAS, UNIVERSITY OF  
BD OF REGENTS OF UNIVERSITY SYS OF GA-GEORGIA  
INSTITUTE OF TECHNOLOGY  
BOSTON UNIVERSITY  
BROWN UNIVERSITY  
CALIFORNIA BERKELEY, UNIVERSITY OF  
CALIFORNIA DAVIS, UNIVERSITY OF  
CALIFORNIA INST OF TECHNOLOGY  
CALIFORNIA LOS ANGELES, UNIV  
CALIFORNIA SAN DIEGO, UNIV  
CALIFORNIA SAN DIEGO, UNIV-SCRIPPS INST OF OCEAN  
CALIFORNIA SAN FRANCISCO, UNIV  
CALIFORNIA SANTA CRUZ, UNIV  
CLEMSON UNIVERSITY  
COLORADO STATE UNIVERSITY  
COLUMBIA UNIVERSITY  
CORNELL UNIVERSITY  
DAKOTA STATE UNIVERSITY  
DREXEL UNIVERSITY  
FLORIDA, UNIVERSITY OF CENTRAL  
HARVARD UNIVERSITY  
HAWAII PACIFIC UNIVERSITY  
JOHNS HOPKINS UNIVERSITY  
KANSAS STATE UNIVERSITY  
LANGUAGE LEARNING PGM-UNIV MICHIGAN  
MARYLAND, UNIVERSITY OF  
MASSACHUSETTS INSTITUTE OF TECH  
MICHIGAN, UNIVERSITY OF  
MINNESOTA, UNIVERSITY OF  
MISSOURI-ST. LOUIS, UNIVERSITY OF  
MOREHOUSE SCHOOL OF MEDICINE  
NEVADA LAS VEGAS, UNIVERSITY OF  
NEVADA SYSTEM OF HIGHER EDUCATION (NSHE)-BOARD  
OF REGENTS  
NEW HAMPSHIRE, UNIVERSITY OF  
NEW MEXICO, UNIVERSITY OF  
NEW YORK UNIVERSITY  
NORTHEASTERN UNIVERSITY  
NOTRE DAME, UNIVERSITY OF  
OHIO STATE UNIVERSITY  
OREGON HEALTH SCIENCES UNIVERSITY

OREGON STATE UNIVERSITY  
PITTSBURGH, UNIVERSITY OF  
PORTLAND STATE UNIVERSITY  
PURDUE UNIVERSITY  
RICE UNIVERSITY  
RUTGERS, STATE UNIVERSITY OF NEW JERSEY  
SOUTHERN CALIFORNIA, UNIVERSITY OF  
STATE UNIVERSITY OF NEW YORK  
TEXAS AUSTIN, UNIVERSITY OF  
TEXAS-SAN ANTONIO, UNIVERSITY OF  
THE ADMINISTRATORS OF THE TULANE EDUCATIONAL  
FUND  
THE REGENTS OF THE UNIVERSITY OF CALIFORNIA  
THE TRUSTEES OF COLUMBIA UNIVERSITY IN THE CITY OF  
NEW YORK  
THE UNIVERSITY OF TENNESSEE HEALTH SCIENCE CENTER

UNITED STATES AIR FORCE ACADEMY  
UNIVERSITY ADVANCE CORP, CAL STATE NORTHRIDGE  
UNIVERSITY OF CHICAGO  
UNIVERSITY OF DELAWARE  
UTAH STATE UNIVERSITY  
VANDERBILT UNIVERSITY  
VANDERBILT UNIVERSITY MEDICAL CENTER  
VIRGINIA POLYTECHNIC INST & STATE UNIV  
VIRGINIA, UNIVERSITY OF  
WASHINGTON STATE UNIVERSITY  
WASHINGTON, UNIVERSITY OF  
WAYNE STATE UNIVERSITY  
WEST VIRGINIA UNIVERSITY  
YALE UNIVERSITY



Applied Research Laboratory  
University of Hawai'i

# Status Report

by Dr. Ben Jones  
ARL Associate Director  
October 2018



# Applied Research Laboratory at the University of Hawai'i

## Five Navy University-Affiliated Research Centers (UARCs):

- Johns Hopkins University Applied Physics Laboratory
  - Founded **1942**
  - Primary Focus: Missiles and Satellites
- Applied Physics Laboratory of the University of Washington (APL-UW)
  - Founded **1943**
  - Primary Focus: Acoustics and Arctic Operations
- Applied Research Laboratory at Pennsylvania State
  - Founded in **1945**
  - Primary Focus: Undersea Warfare and Underwater Systems
- Applied Research Laboratories, the University of Texas at Austin
  - Founded in **1945**
  - Primary Focus: Acoustics and Global Positioning
- **Applied Research Laboratory at the University of Hawai'i**
  - Established: **July 15, 2008**
  - Primary Focus: Remote Sensing
  - End Date for Present Contract: **January 14, 2019**
  - Total Ceiling Allotment: \$44.7M for original ten-year contract
  - 2018 Ceiling Supplement: **\$15M**, bringing total for first ten years to **~\$60M**
  - Contract Security Level upgraded to TS this month

# ARL@UH Timeline – First Decade

2008 2009 2010 2011 2012 2013 2014 2015 2016 2017 2018

→ ARL at UH established July 2008 with four core competencies:

- OST
- AST
- AEOS
- SENCIT

\$26.2M Funding ceiling; 232,000 staff hours  
Facility/Safeguarding Clearance: Secret  
UH VP for Research Jim Gaines serves as Executive Director

→ June 2012  
Funding ceiling increased to \$44.7M; 390,000 staff hours

→ VADM USN (Ret.) Mike Vitale appointed Executive Director September 2012

→ July 2013  
ARL at UH renewed for five years

→ April 2014  
#5 Mission-Related R&D added to core competencies

→ June 2014  
Cybersecurity added to UARC contracts

→ November 2014  
#6 New Renewable Energy added to core competencies

→ Margo Edwards appointed Interim Executive Director April 2015

→ Jan 2018  
ARL reaches \$44.7M ceiling



# ARL@UH Core Competencies

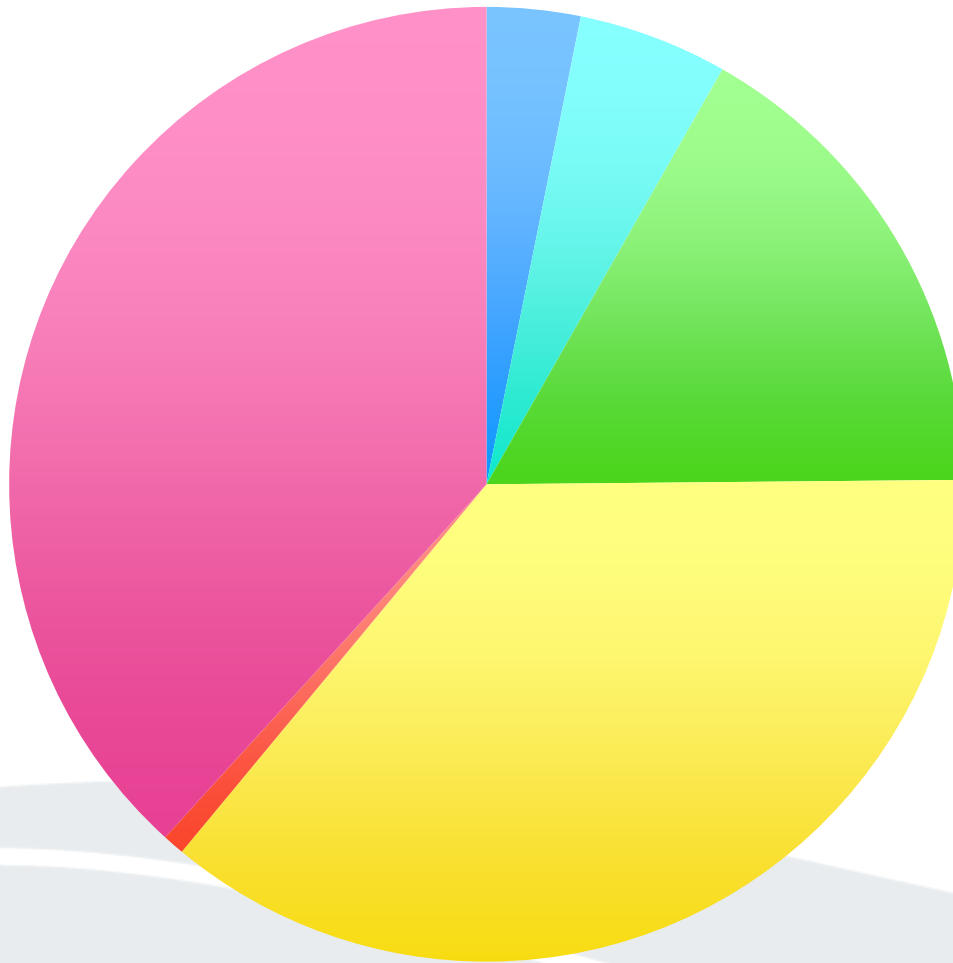

#1: Ocean Science & Technology	\$1,837,835
#2: Astronomy	\$2,937,215
#3: Advanced Electro-Optics & Sensing	\$9,644,806
#4: Sensors, Communications & Information Technology	\$20,982,896
#5: Mission-Related R&D	\$425,930
#6: New Renewable Energy	\$22,191,073

**Total** **\$58,024,755**

# Project Awards per Federal FY (10/1-9/30)\*

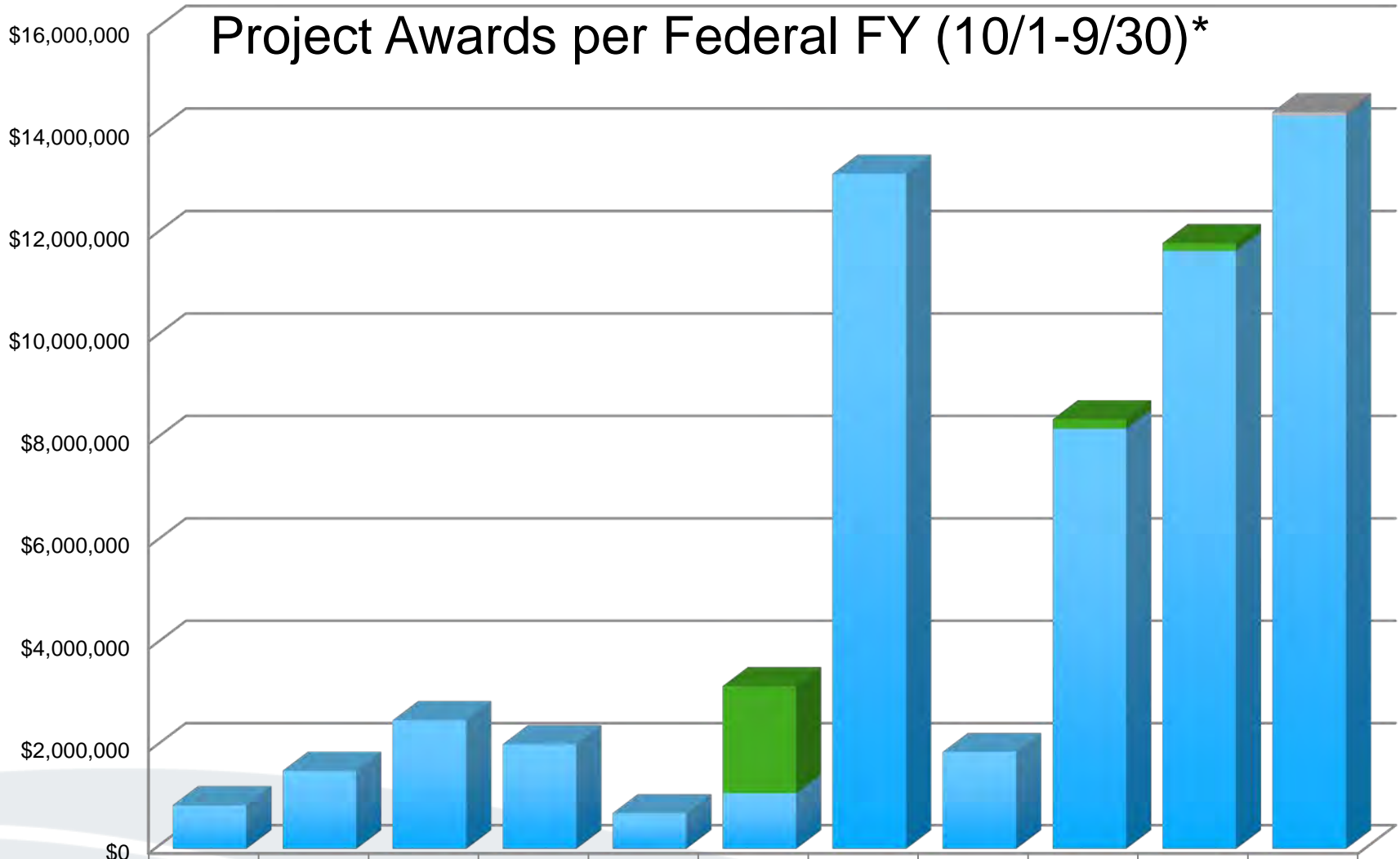

	FY08	FY09	FY10	FY11	FY12	FY13	FY14	FY15	FY16	FY17	FY18
■ Pending											\$80,427
■ DBEDT						\$2,100,000			\$185,000	\$150,000	
■ Prime Contract	\$855,000	\$1,530,431	\$2,518,000	\$2,048,044	\$699,391	\$1,086,404	\$13,187,403	\$1,894,927	\$8,210,337	\$11,684,390	\$14,310,428

***\*Most tasks awarded in August/September***

# Project Expenditures per UH FY (7/1-6/30)

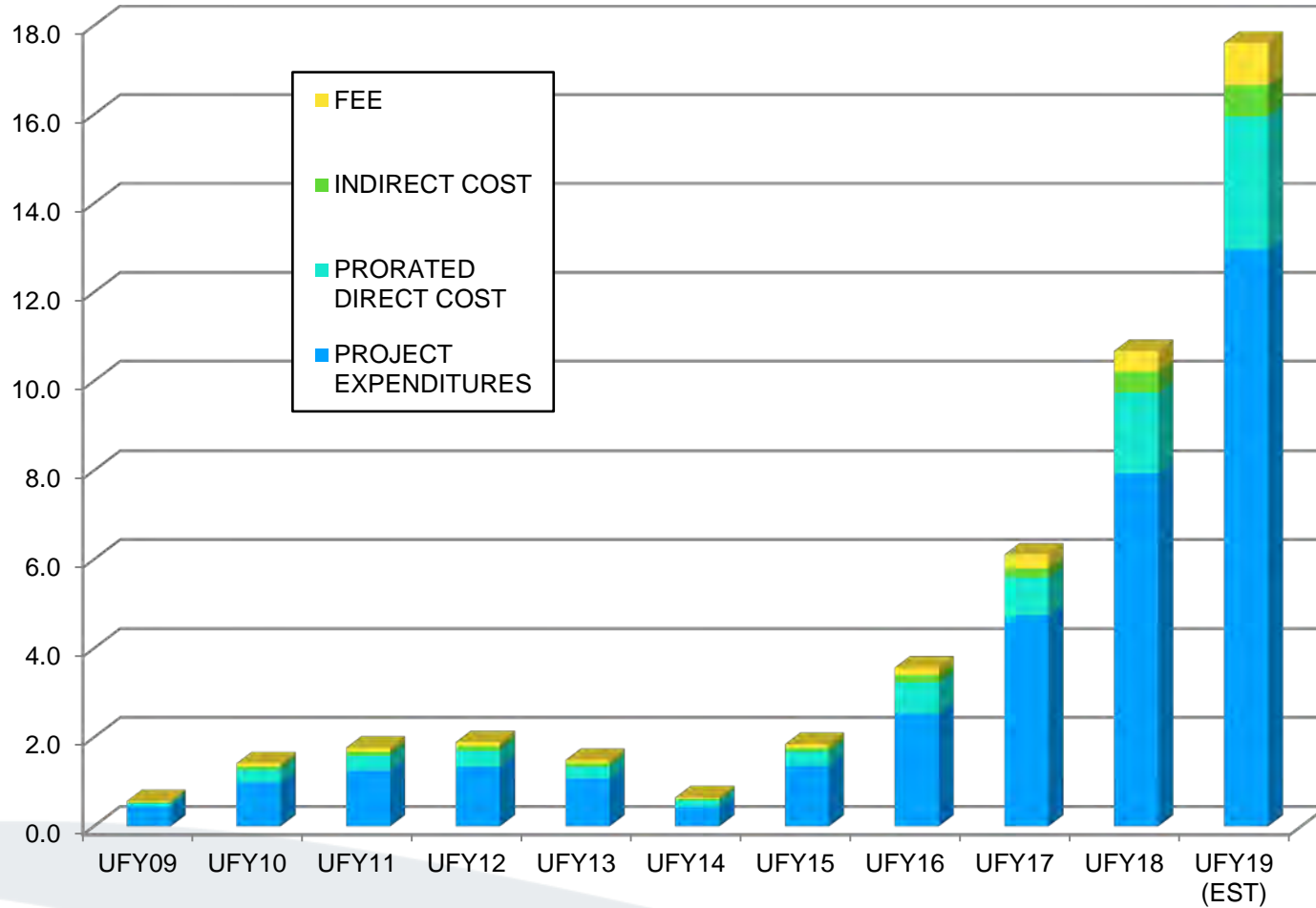

\$ IN MILLIONS	UFY09	UFY10	UFY11	UFY12	UFY13	UFY14	UFY15	UFY16	UFY17	UFY18	UFY19 (EST)
PROJECT EXPENDITURES	0.4	1.0	1.3	1.3	1.1	0.4	1.4	2.5	4.7	7.9	13.0
PRORATED DIRECT COST	0.1	0.3	0.3	0.4	0.3	0.2	0.3	0.7	0.8	1.8	3.0
INDIRECT COST	0.0	0.1	0.1	0.1	0.1	0.0	0.1	0.2	0.2	0.5	0.7
FEE	0.0	0.1	0.1	0.1	0.1	0.0	0.1	0.2	0.3	0.5	1.0
<b>TOTALS (\$M)</b>	<b>0.6</b>	<b>1.4</b>	<b>1.8</b>	<b>1.9</b>	<b>1.5</b>	<b>0.7</b>	<b>1.8</b>	<b>3.6</b>	<b>6.1</b>	<b>10.7</b>	<b>17.6</b>

# ARL@UH Funding by Service Branch

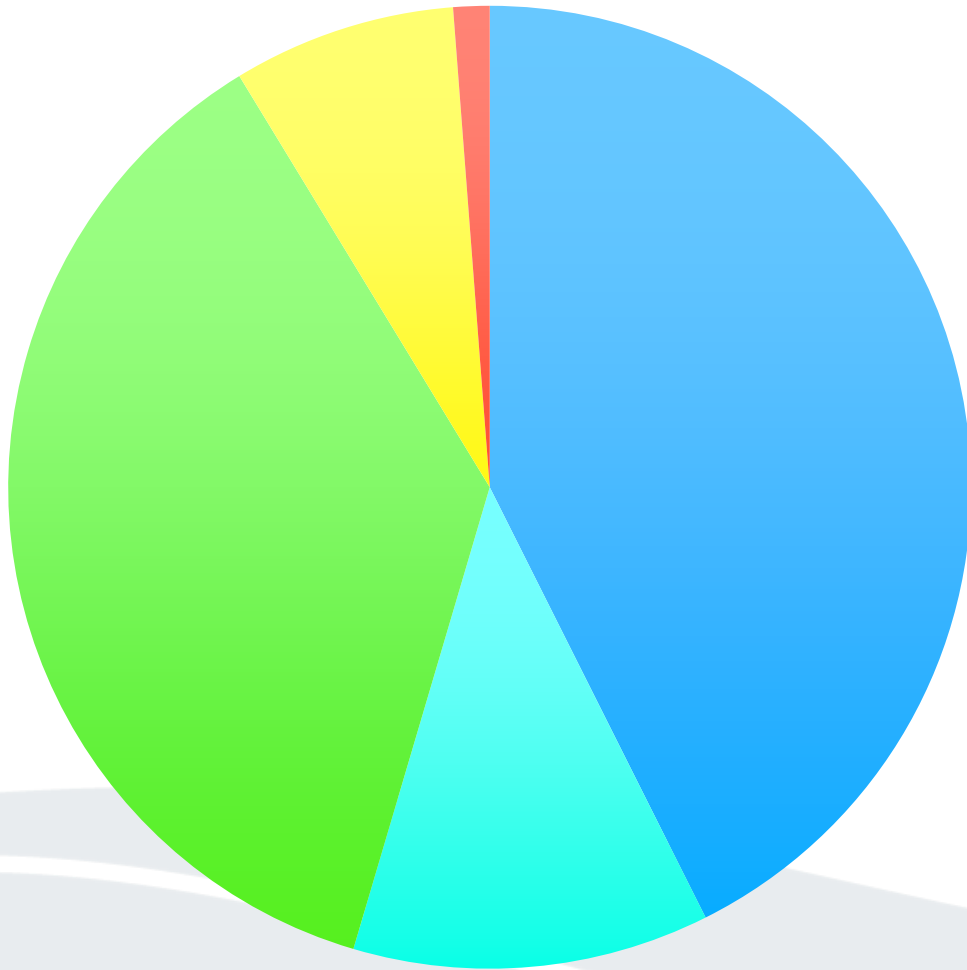

■ Navy	\$24,718,355
■ Army	\$6,946,473
■ Air Force	\$21,307,735
■ IC	\$4,346,472
■ COCOM	\$705,720
<b>Total</b>	<b>\$58,024,755</b>

# Summary of Currently Active Tasks

50 Tasks Awarded since ARL was Established

As of September 30, 2018

<u>Task Order</u>	<u>Task Title</u>	<u>ROF Date</u>	<u>End Date</u>	<u>Cost</u>
16	Support for the Hawaii Wave Energy Test Site	7/16/2014	3/29/2019	9,001,059.00
19	Navy Hawaii Infrastructure Modernization and Renewable Integration Project	9/4/2014	12/21/2018	2,500,000.00
33	Additional Tasking for ARL/HNEI Wave Energy Test Site (WETS) Research	9/26/2016	9/28/2019	3,747,990.00
34	Hawaii Advanced Inverter Demonstration Project	9/8/2016	12/31/2018	395,628.00
17F8801	Research and Development for DoD Vanguard Center of High Performance Computing	8/11/2017	11/10/2018	9,996,329.00
17F8802	Maui High Performance Center Solutions to Pacific Theater HPC and C41 Requirements III	9/20/2017	9/19/2019	770,838.00
18F8800	InfraRed Celestial Reference Frame Observations using the United Kingdom InfraRed Telescope II (UKIRT II)	1/31/2018	1/30/2019	1,400,000.00
18F8802	Research and Development for the DoD at the Maui High Performance Computing Center (MHPCC) Vanguard Center for High Performance Computing (VCHPC)	9/18/2018	9/30/2019	6,861,157.00
18F8804	Extended Research Support to the U.S. Navy Wave Energy Test Site (WETS)	7/11/2018	7/10/2021	5,820,895.00
18F8805	IT Security Review of IFA Federally Funded Telescope Operations	9/17/2018	3/16/2019	65,335.00
18F8806	Hawaii Telescope Operations and Capabilities	9/17/2018	9/16/2019	13,041.00
18F8807	Unmanned Aircraft System (UAS) Logistical Delivery Capabilities	9/17/2018	9/16/2019	150,000.00

# Internal R&D Investment

Title	Unit	Award
Energy from a Small Wave Drone	College of Engineering	\$62,438
Cybersecurity for Internet of Things	College of Engineering	\$45,079
Cybersecurity for ARL Tasks	HIGP/SOEST	\$26,969
Neutron Detector for Radioactive Materials	College of Natural Sciences	\$82,302
Unmanned Port Security Vehicle	HIGP/SOEST	\$78,152
Countering Unmanned Aerial Systems	College of Engineering	\$30,499
MOU with University of Porto on Unmanned Swarms	HIGP/SOEST	\$40,000
Nondestructive Microscale Materials	HIGP/SOEST	\$67,614
Cybersecurity for Internet of Things, Phase II	College of Engineering	\$67,624
Small Satellite Launch Sites	HIGP/SOEST	\$40,000
Testing of a Raman-Fluorescence Sensor	HIGP/SOEST	\$50,181
Nanocomposite Materials for Energy Storage	College of Engineering	\$30,000
	<b>TOTAL FEE IRAD</b>	<b>\$620,858</b>
	Total College of Engineering	\$235,640
	Total HIGP/SOEST	\$302,916
	Total College of Natural Sciences	\$82,302



# Ocean Energy



# Columbia Power

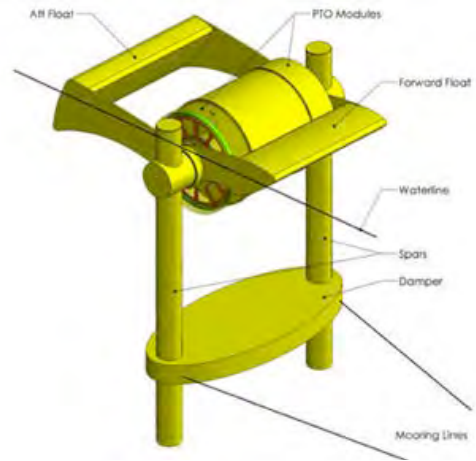

## Extramurally Funded Tasks: Wave Energy Test Site

Patrick Cross, Principal Investigator, Hawaii Natural Energy Institute (HNEI)  
\$18.6M funded to date



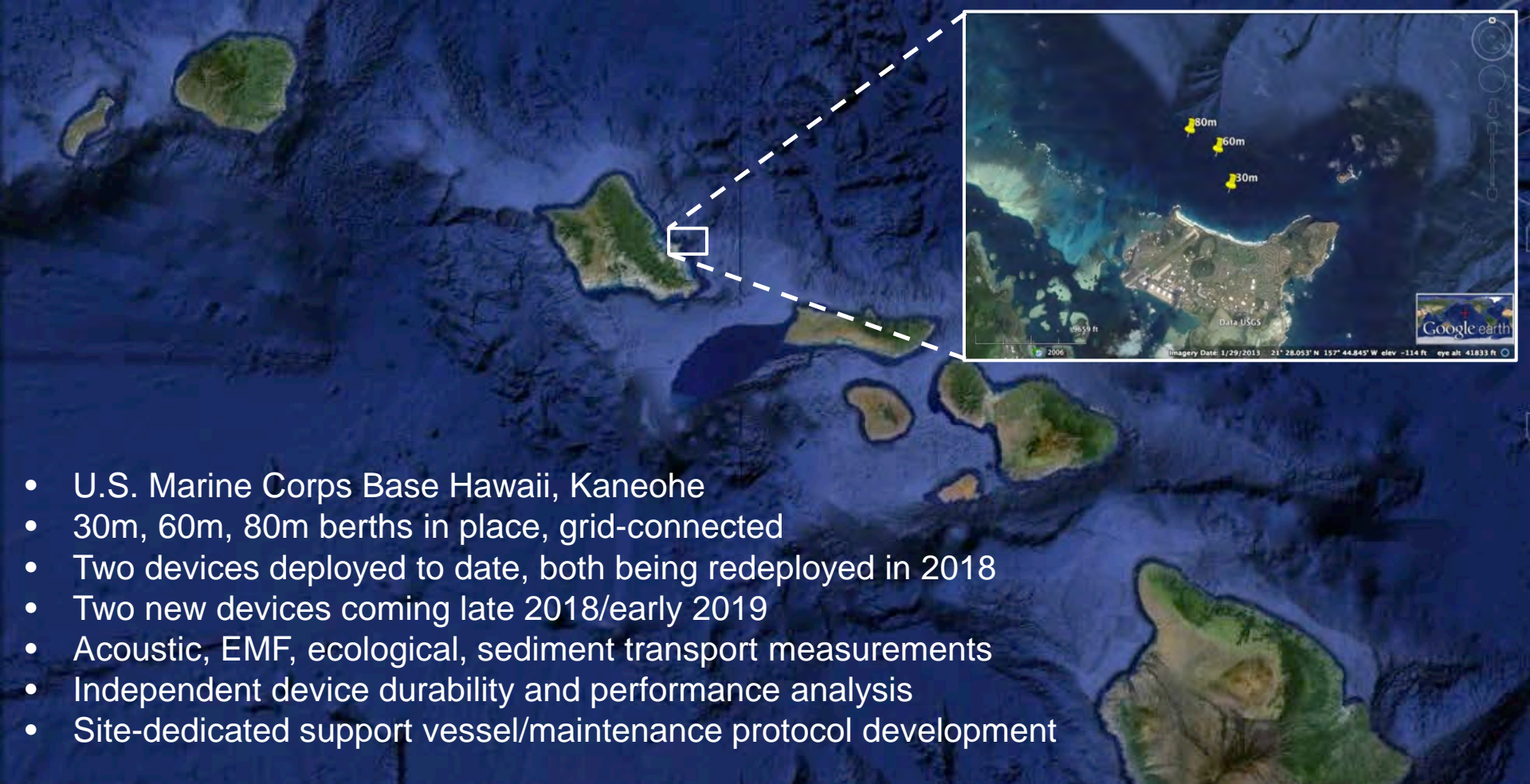

- U.S. Marine Corps Base Hawaii, Kaneohe
- 30m, 60m, 80m berths in place, grid-connected
- Two devices deployed to date, both being redeployed in 2018
- Two new devices coming late 2018/early 2019
- Acoustic, EMF, ecological, sediment transport measurements
- Independent device durability and performance analysis
- Site-dedicated support vessel/maintenance protocol development



# Institute for Astronomy

Guenther Hasinger, Klaus Hodapp & Peter Onaka, Principal Investigators  
\$2.7M funded to date by Air Force Research Lab, US Naval Observatory

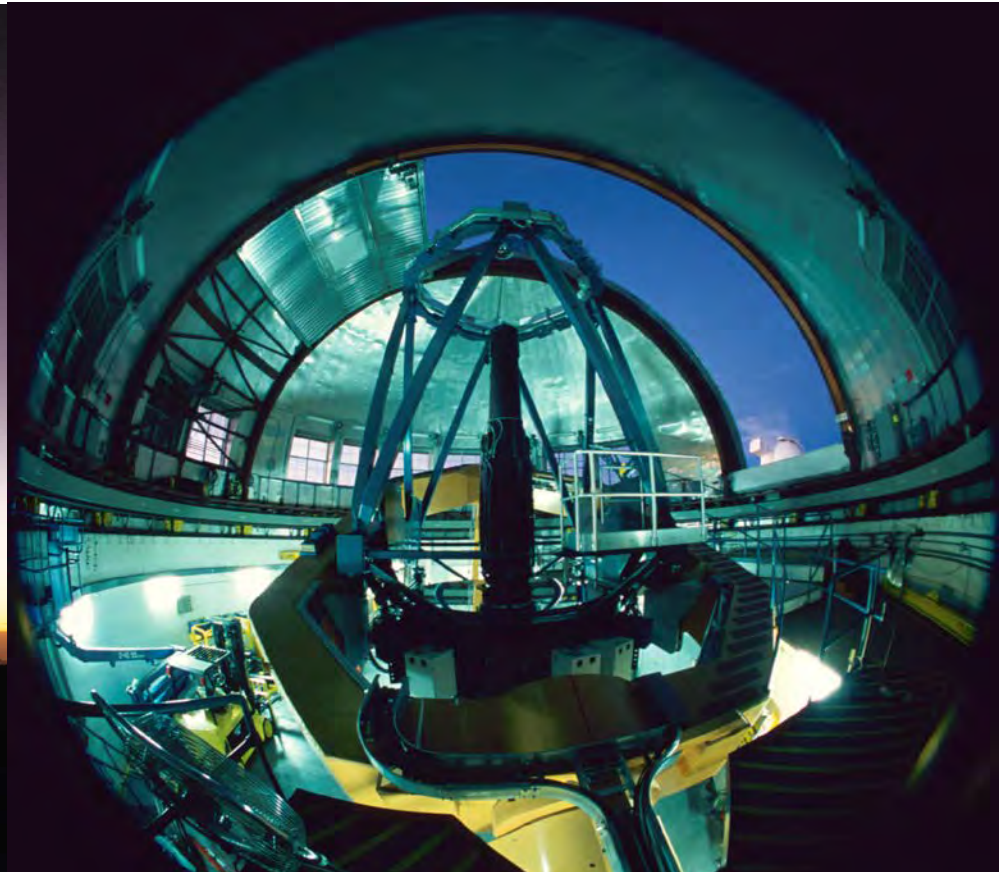

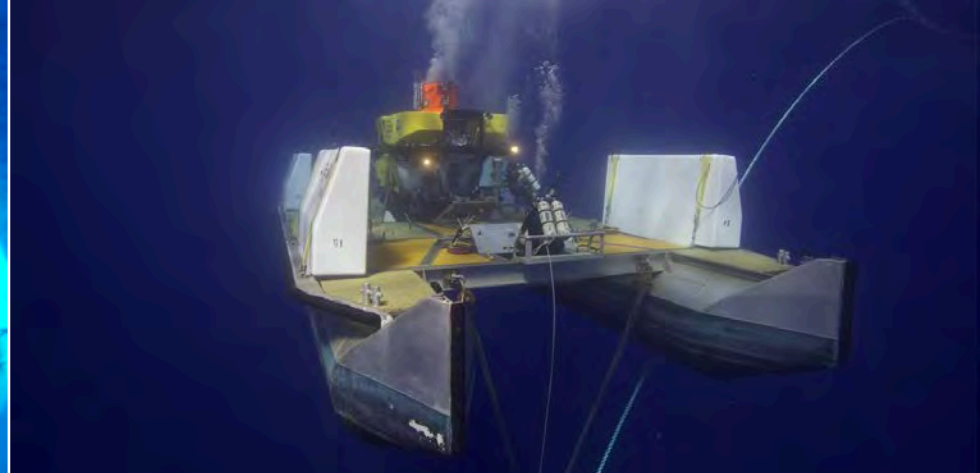
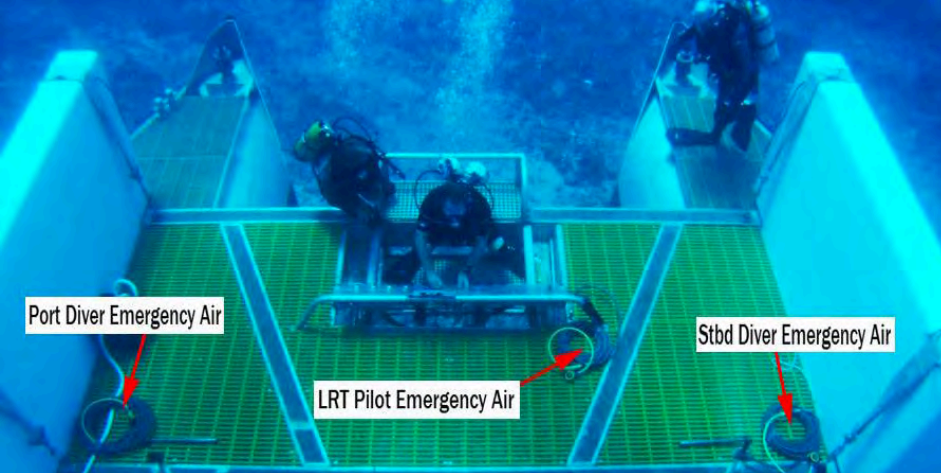

## Extramurally Funded Tasks: Launch Recover Transport Vehicle Training

Alexander Shor, Principal Investigator

with Hawaii Undersea Research Lab (HURL) Sponsored by USSOCOM

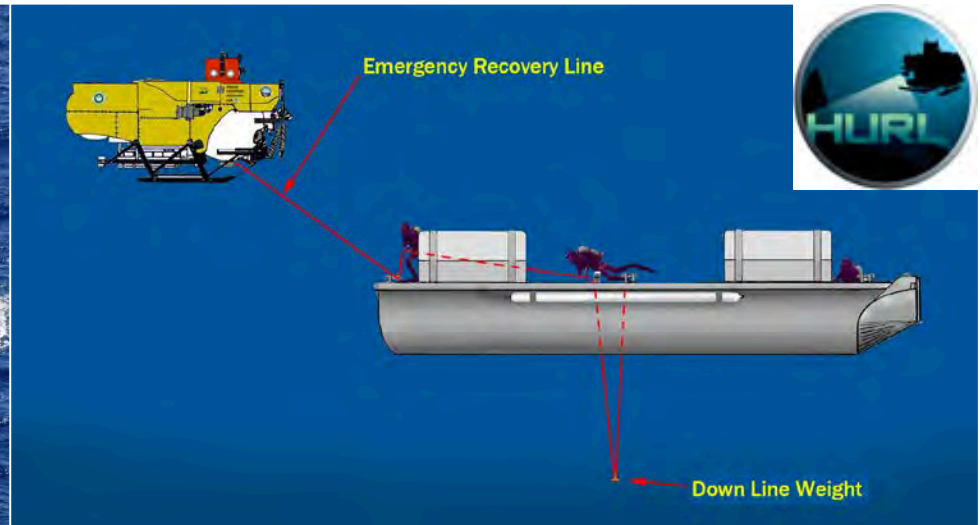
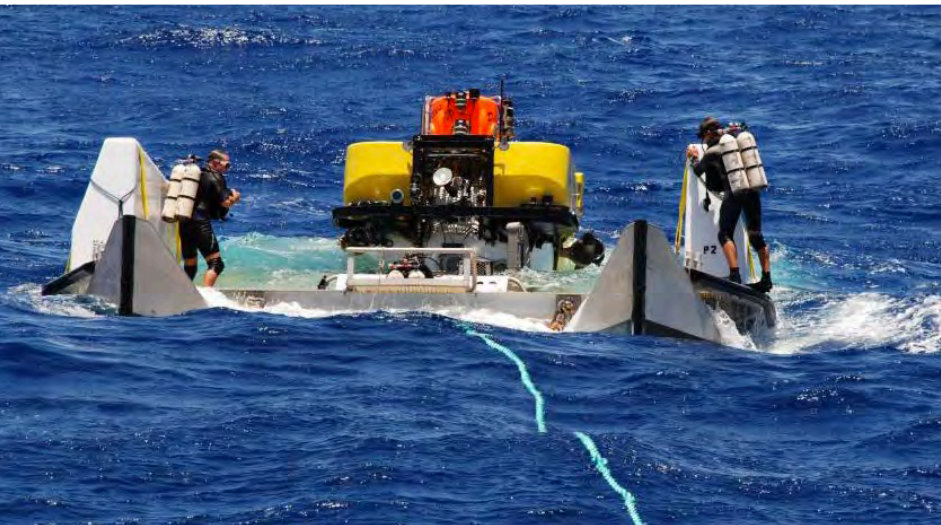

# Internally Funded Tasks: NuLat Neutrino Lattice

John Learned, Principal Investigator, Physics Department  
\$82K Internal Research and Development Support from ARL



## Key Features and Applications:

- Directional neutron and neutrino detection
  - Neutrinos help us find and investigate nuclear material
  - Nuclear reactor monitoring
  - Provides a new 'window' into physical phenomena: geothermal activity, supernovae, and the big bang

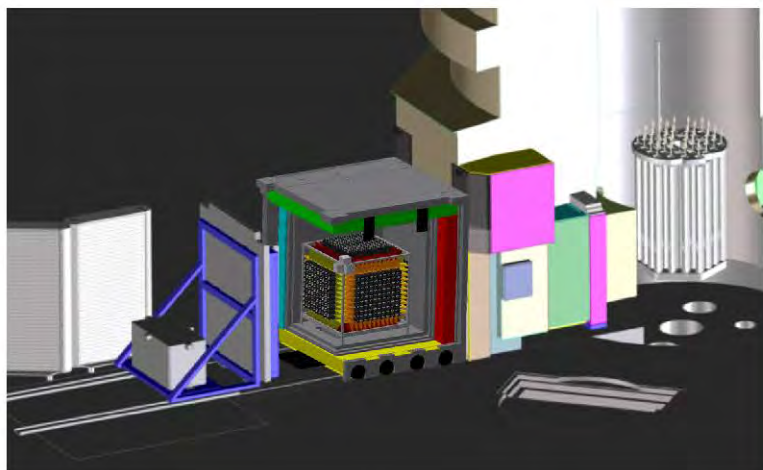

Simulated tests at a nuclear reactor



Potential deployment with shield (above left) at North Anna reactor (above)



# Stand-off IED Detection

Paul Lucey & Shiv Sharma, Principal Investigators, HIGP

\$5.3M funded to date by Army

\$45K Internal Research and Development Support from ARL

## 1st and 2<sup>nd</sup> Generation: Relay UCHIS

Lab prototype

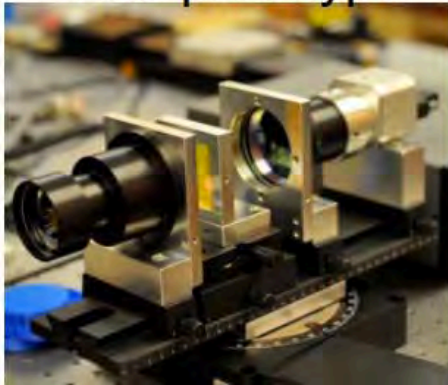

Field Test Unit

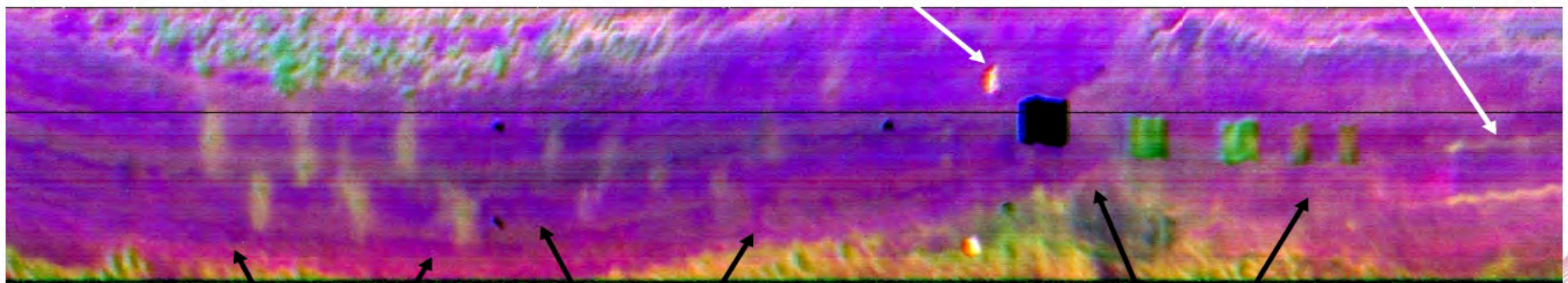
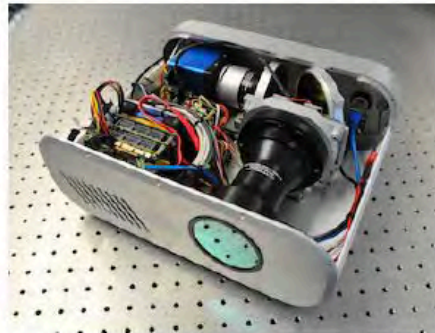

**New  
Mines**

**Older  
Mines**

**(Calibration Panels)**

# ARL Student Training and Internships



# Exercises: Coconut Island Unmanned Systems Demo 3/11/2018

University of Hawai'i  
Engineering Students



Stakeholders:  
PACOM, SUBPAC, NAVSEA, NAVAIR, ONR,  
NOAA, NASA, local industry

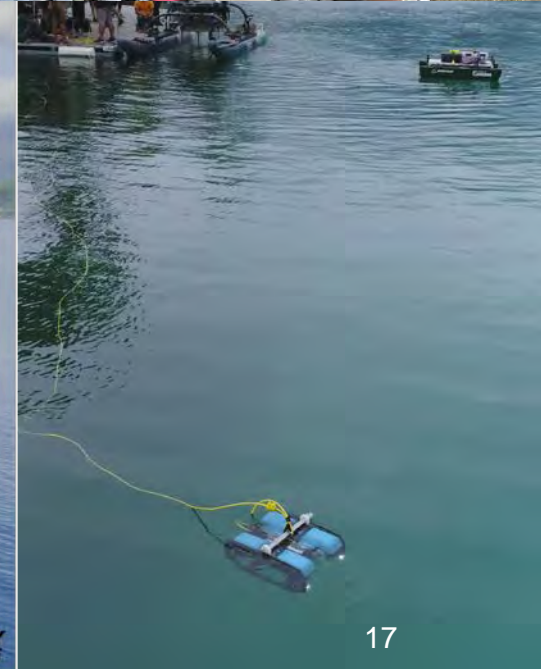
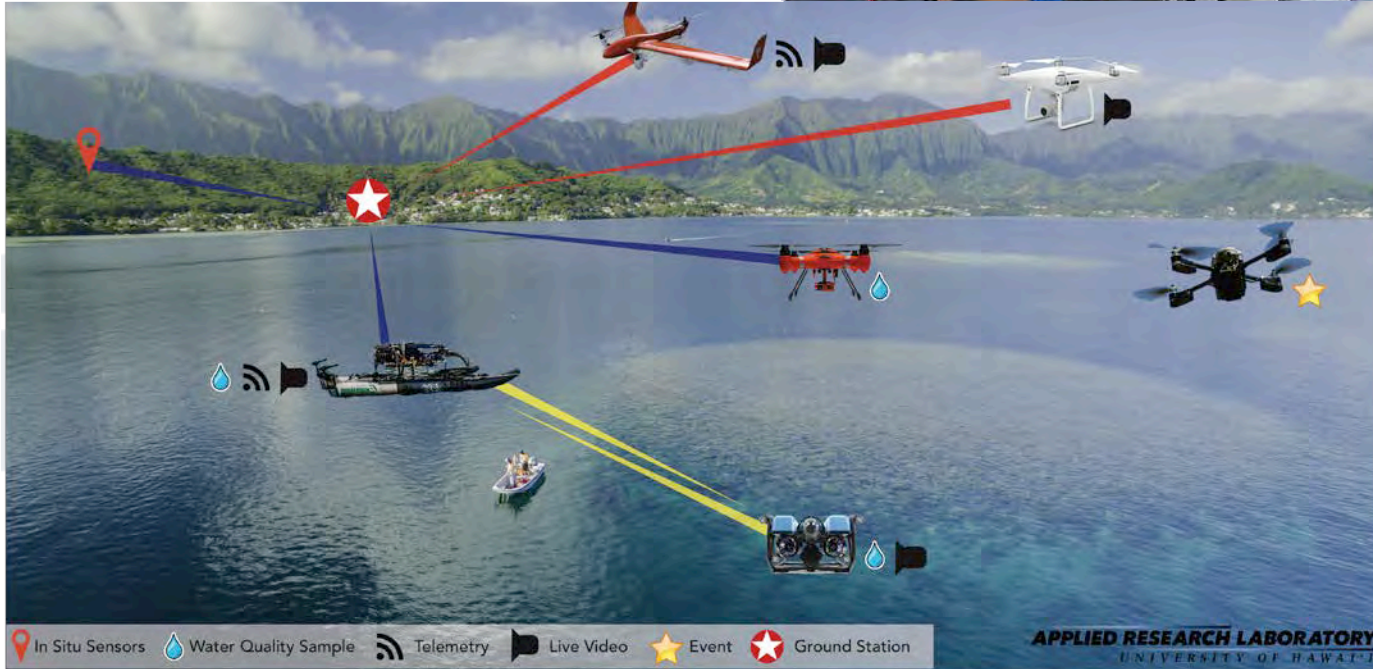



# Exercises: Portugal Rapid Environmental Picture SEP2018



# Pacific Ocean Science and Technology Conference, RIMPAC & EW TANG Innovation Fairs



# INDOPACOM J4 & ARL Collaboration: Unmanned Aerial Systems for the Coral Triangle Initiative



Fusion Center Workshop & Table Top Exercise  
Manado , North Sulawesi , Indonesia | July 31 - August 3, 2018

# Community Outreach: Drone Boot Camp 3/30/2018

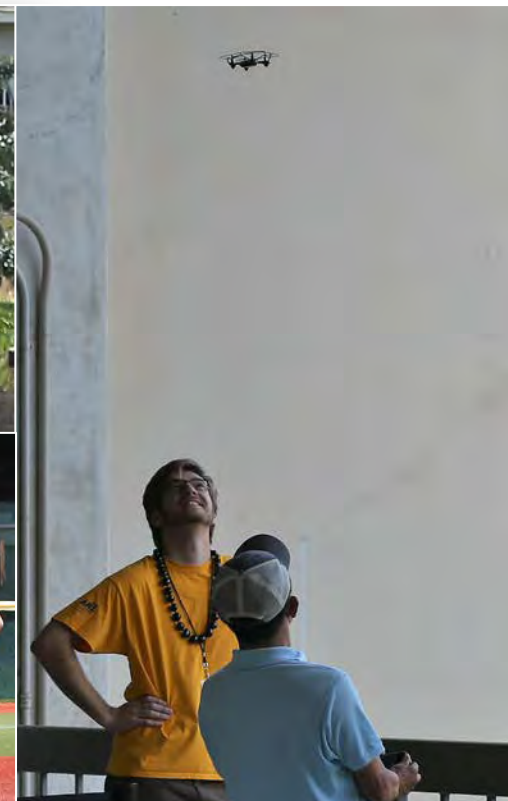

Photos Courtesy D. Leong

# ARL Looking Forward

## Next Contract

Duration: 5 years

Anticipated Ceiling Allotment: \$80M

Target Award Date: **December 2018**

Contract Security: Upgrade to Sensitive Compartmented Information

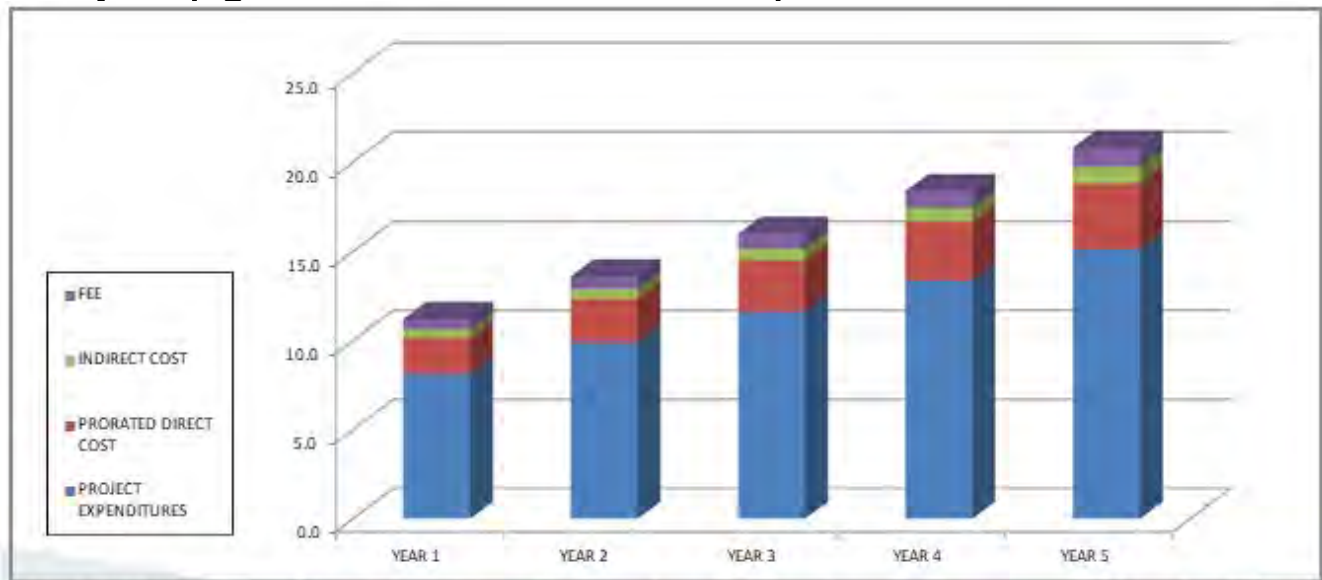

ARL FIVE YEAR PLAN	YEAR 1	YEAR 2	YEAR 3	YEAR 4	YEAR 5	TOTAL
<b>LABOR HOURS</b>	<b>68,949</b>	<b>83,724</b>	<b>98,498</b>	<b>113,273</b>	<b>128,048</b>	<b>492,492</b>
<b>EXPENDITURES \$M</b>						
PROJECT EXPENDITURES	8.1	9.9	11.6	13.4	15.1	58.2
PRORATED DIRECT COST	2.0	2.4	2.9	3.3	3.7	14.3
INDIRECT COST	0.5	0.6	0.7	0.8	0.9	3.4
FEE	0.6	0.7	0.8	0.9	1.1	4.1
<b>TOTALS \$M</b>	<b>11.2</b>	<b>13.6</b>	<b>16.0</b>	<b>18.4</b>	<b>20.8</b>	<b>80.0</b>

# Strategic Directions

## Extramural Awards Targets vs. Actuals

### FY 15 – FY 18

---

BOR Research & Innovation Committee



# Strategic Directions Targets

---

- FY 2014 base year
  - Most current data at time FY 15 – FY 21 projections were made
  - Projections are not influenced by temporary stimulus funding (ARRA awards ended prior to FY 14)
- Based on historical trends, a 5% growth rate per year was used to generate targets



# UH Historical Awards

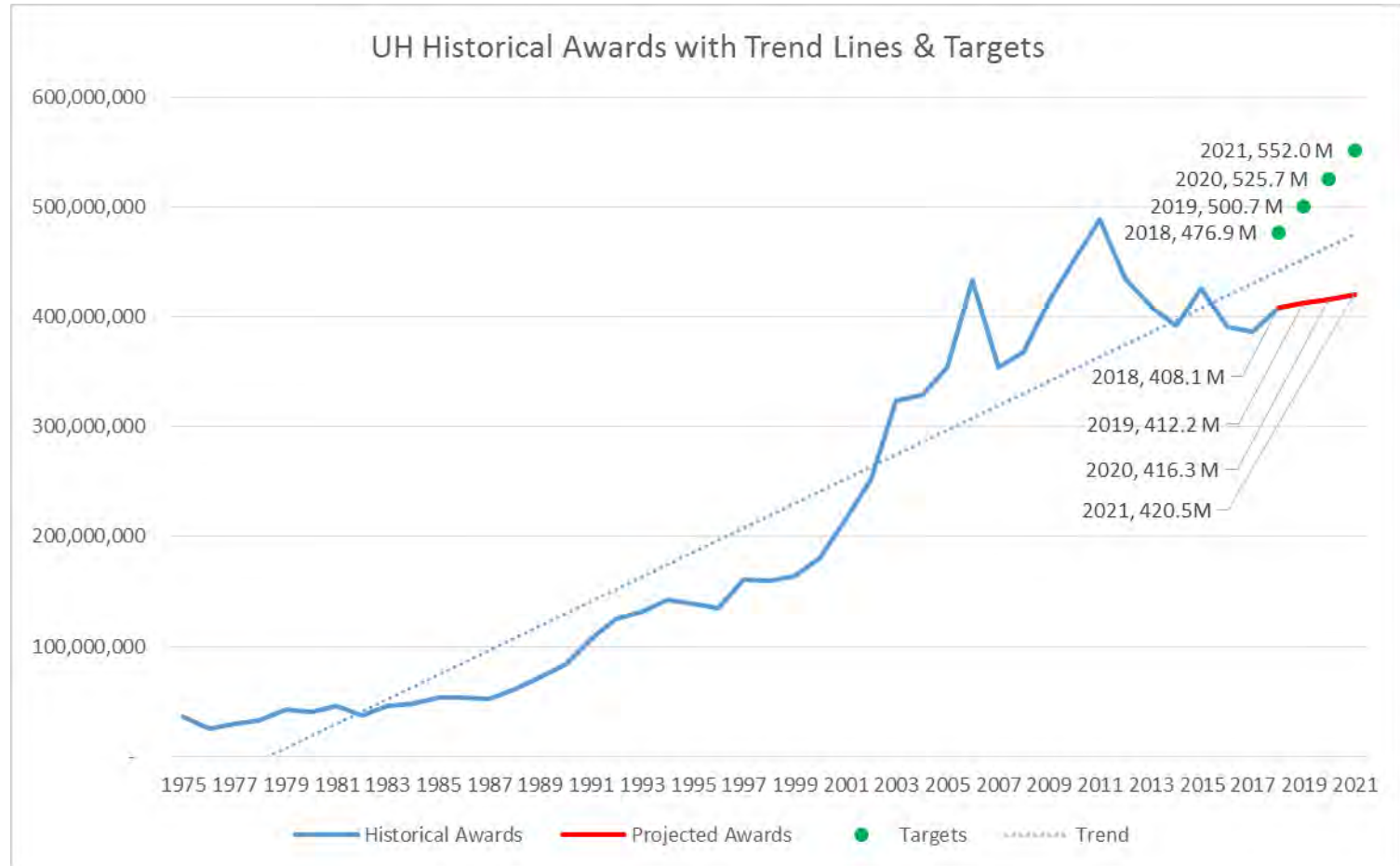



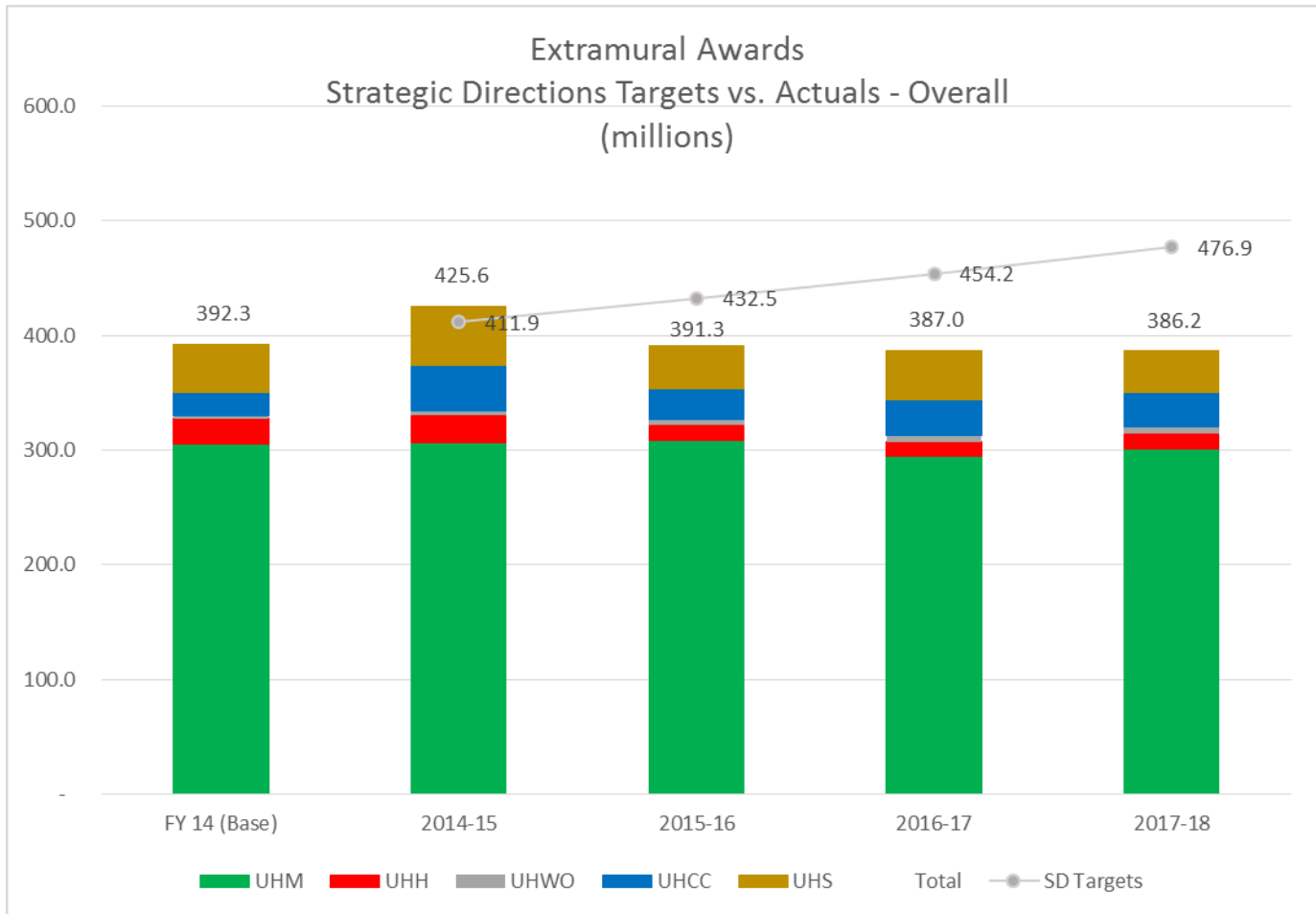

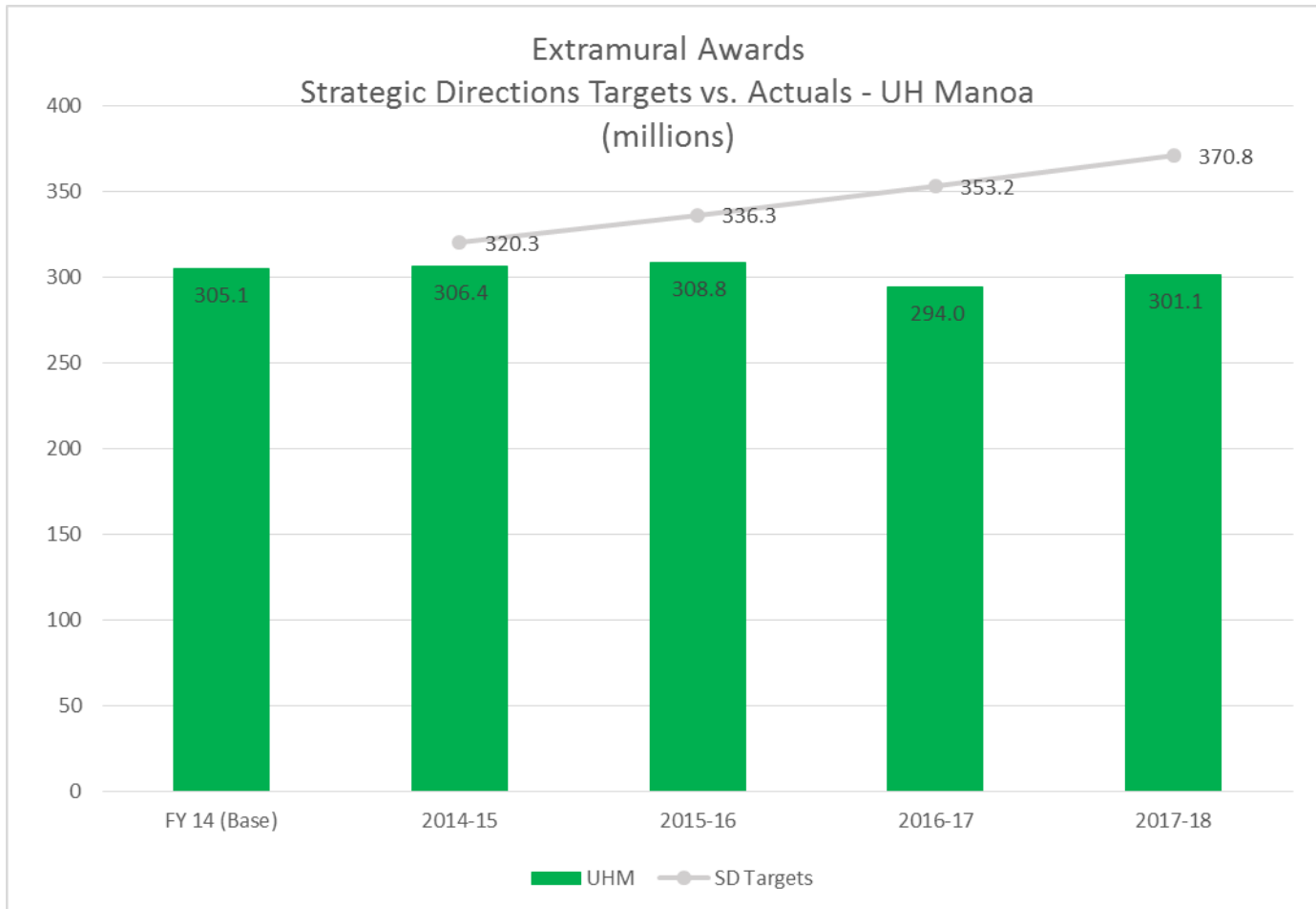

# Research-Active Unit Decreases

---

*Decrease in I, R and M Permanent Faculty  
FY 2012 to FY 2016*

Unit	FY 2012	FY 2016	Decrease
SOEST	126	118	8
JABSOM	68	62	6
IfA	41	34	7
Natural Sciences	121	107	14
Engineering	54	47	7



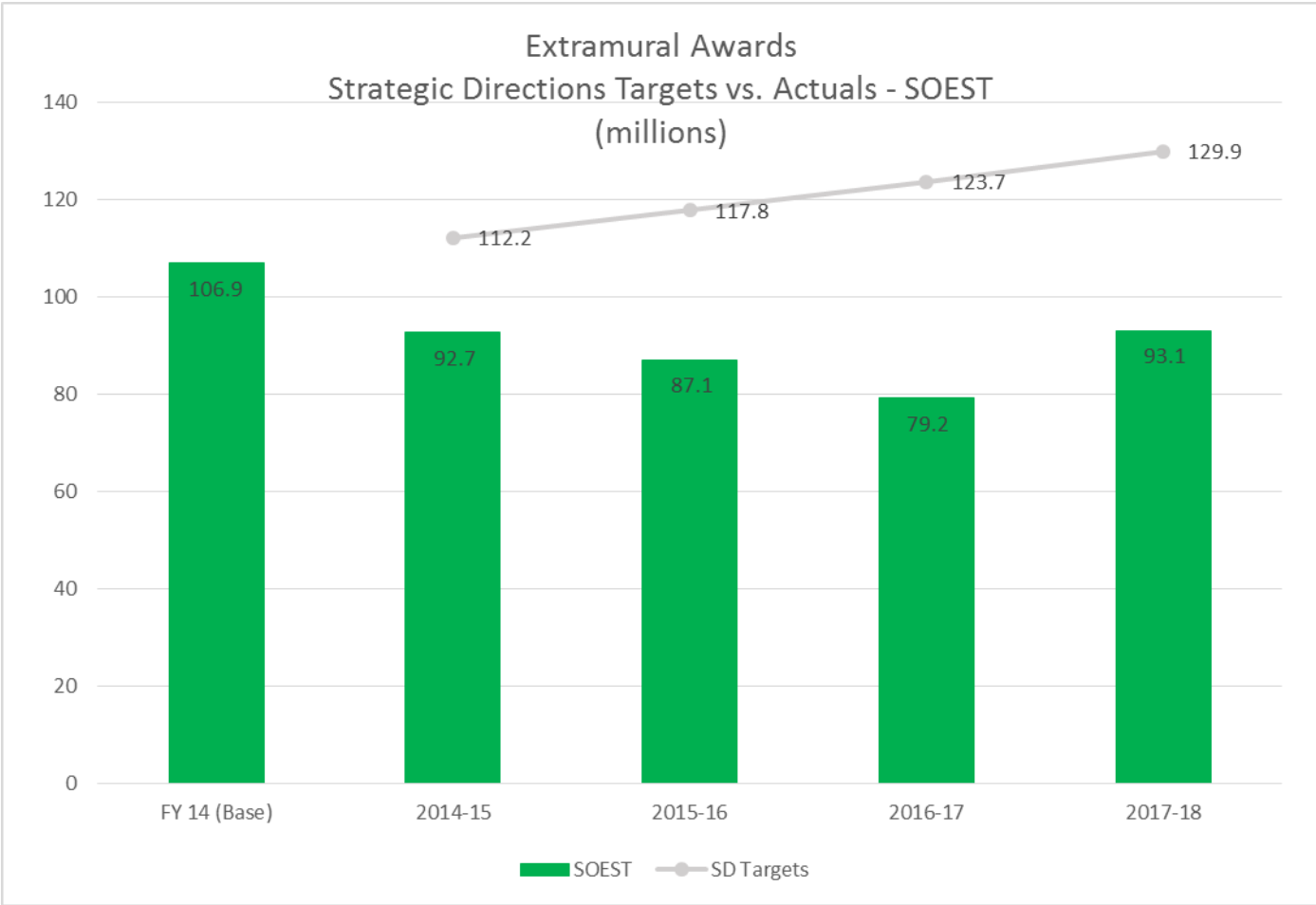

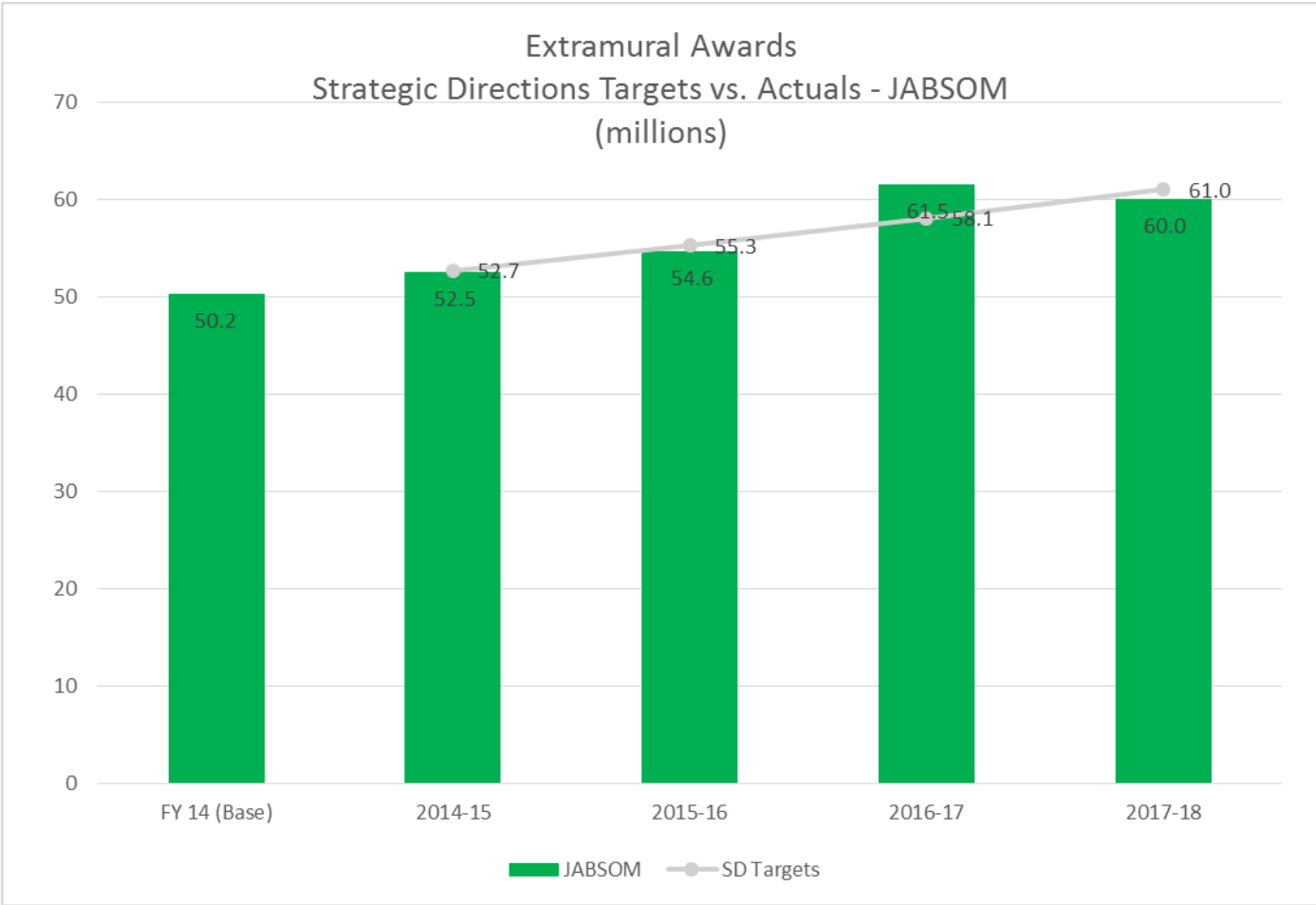

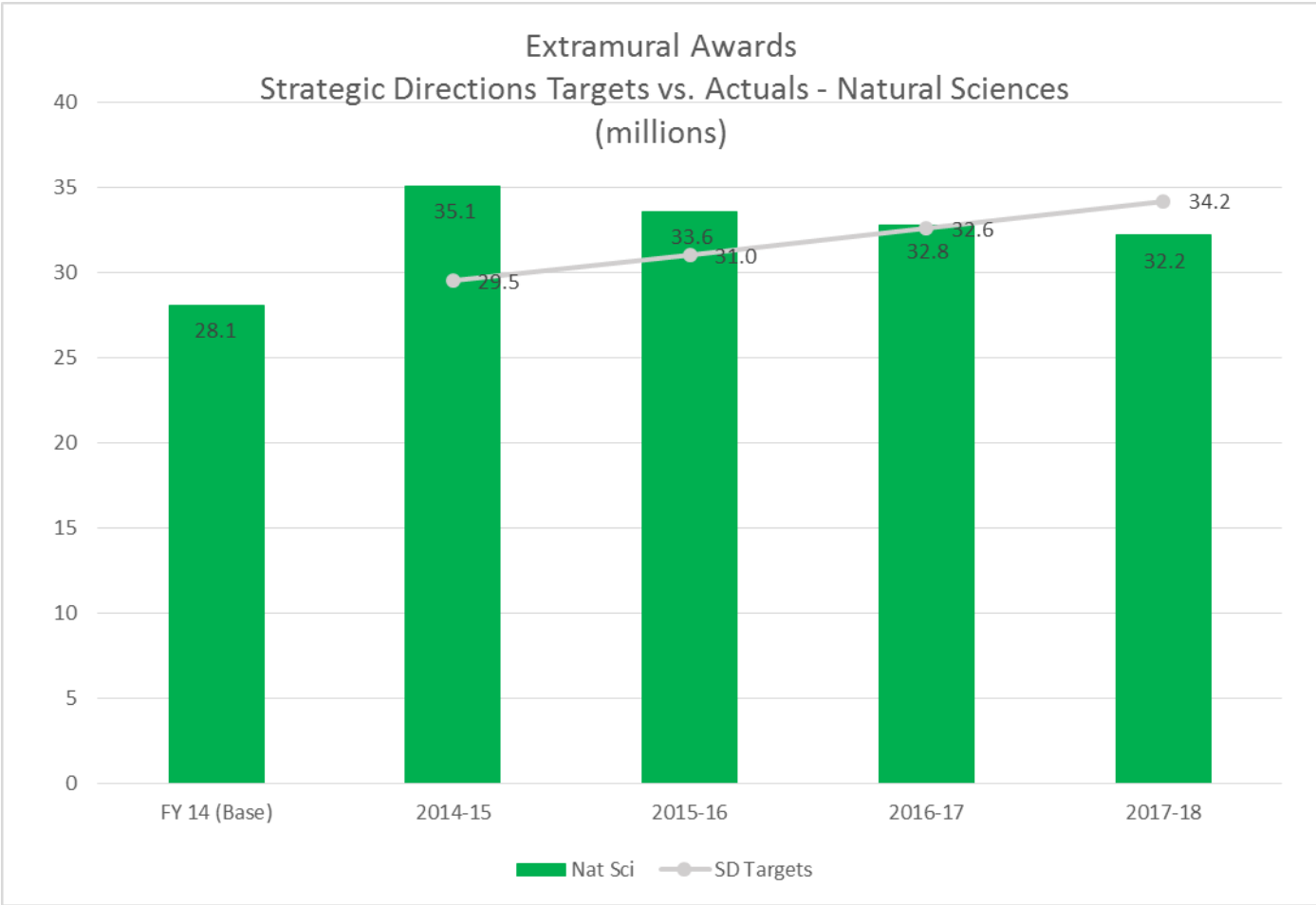

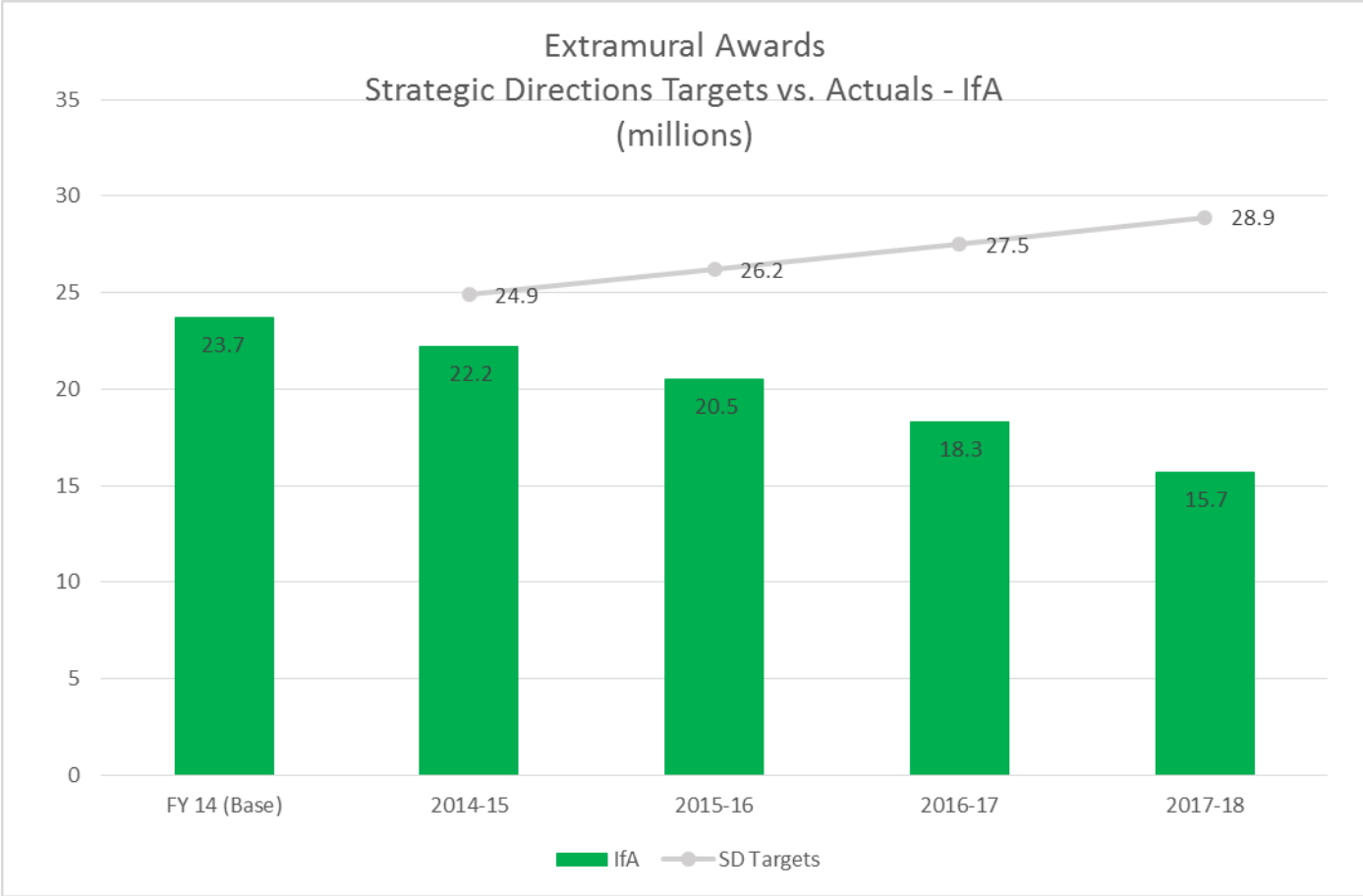

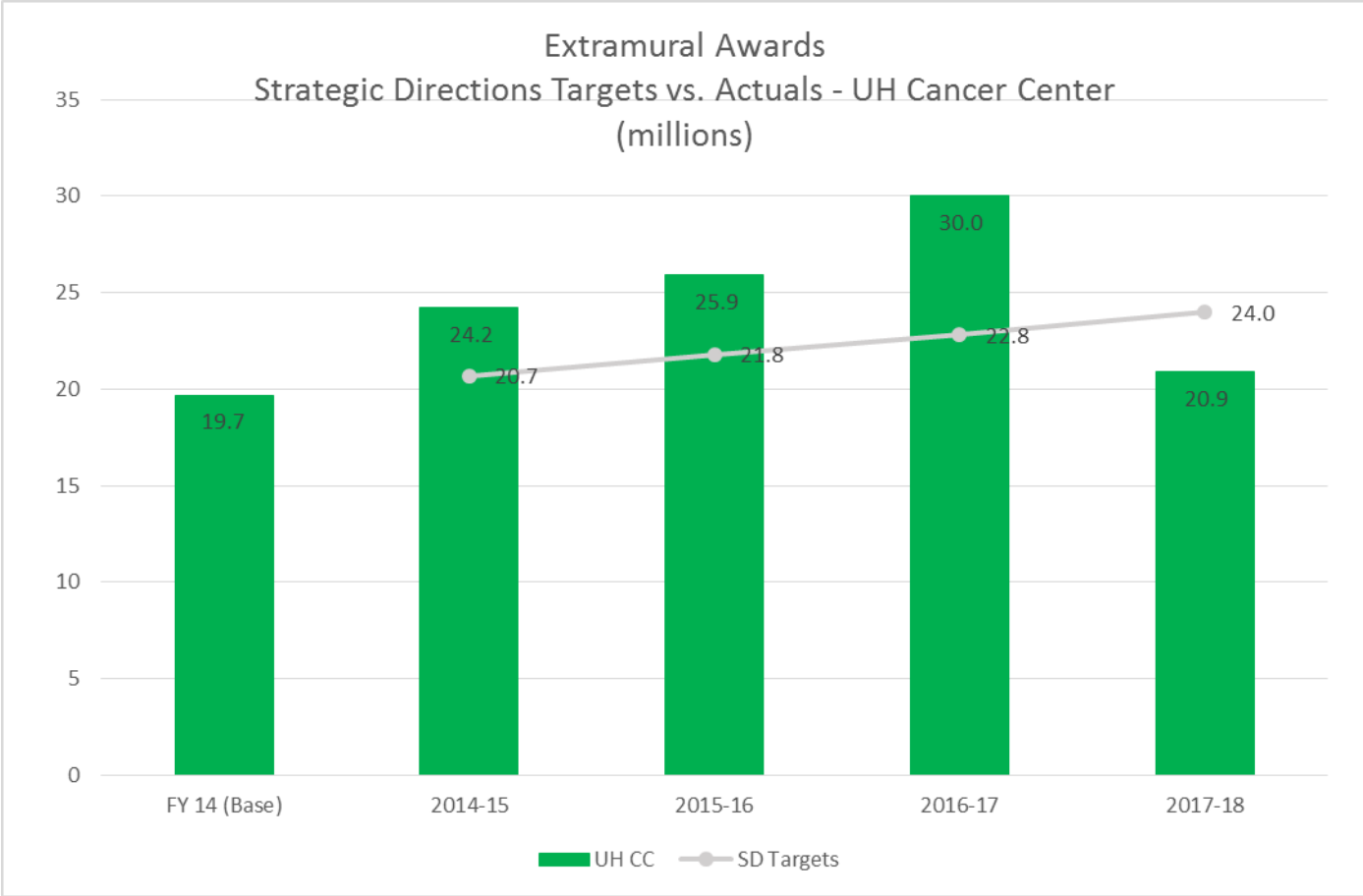



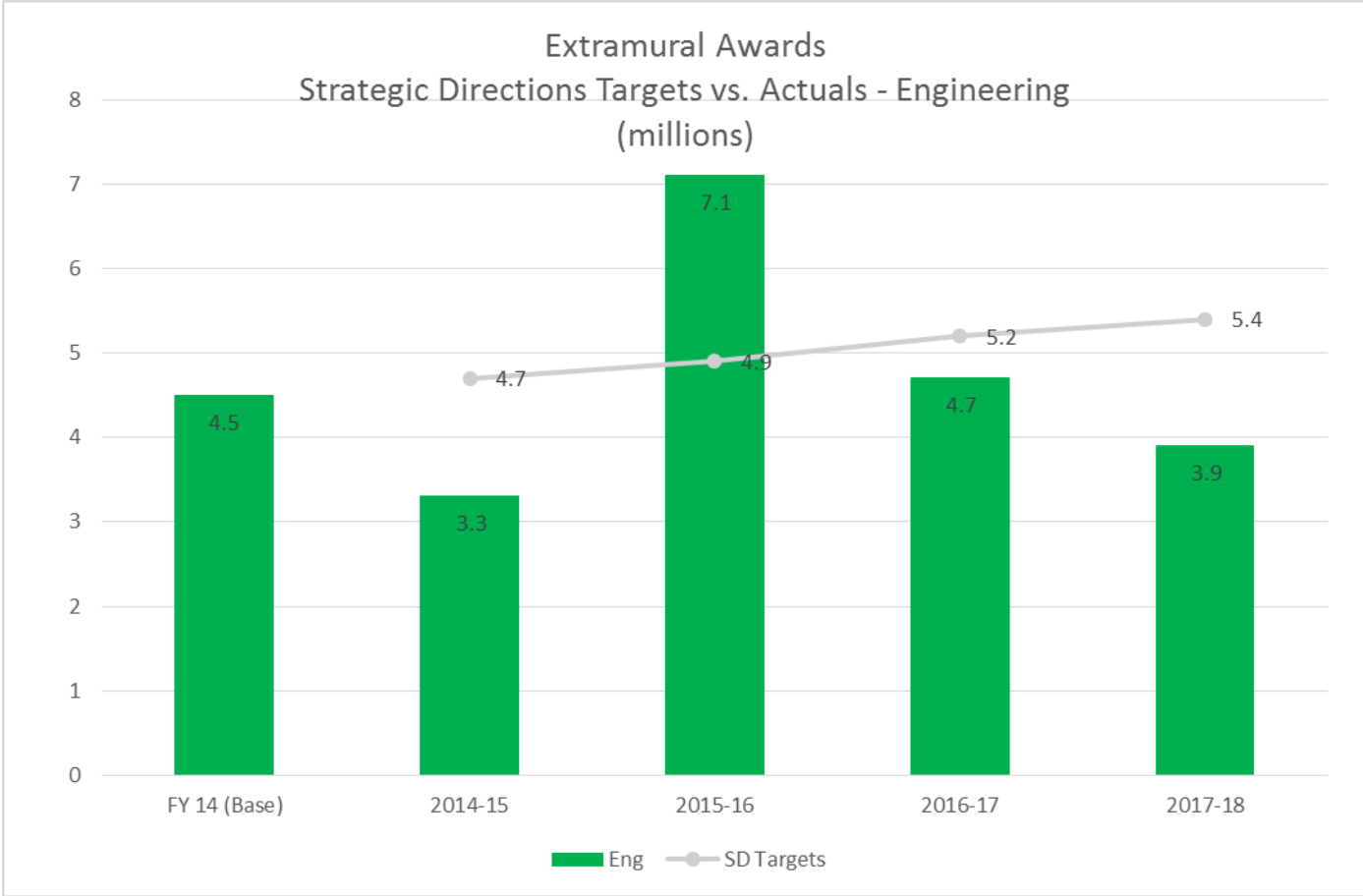

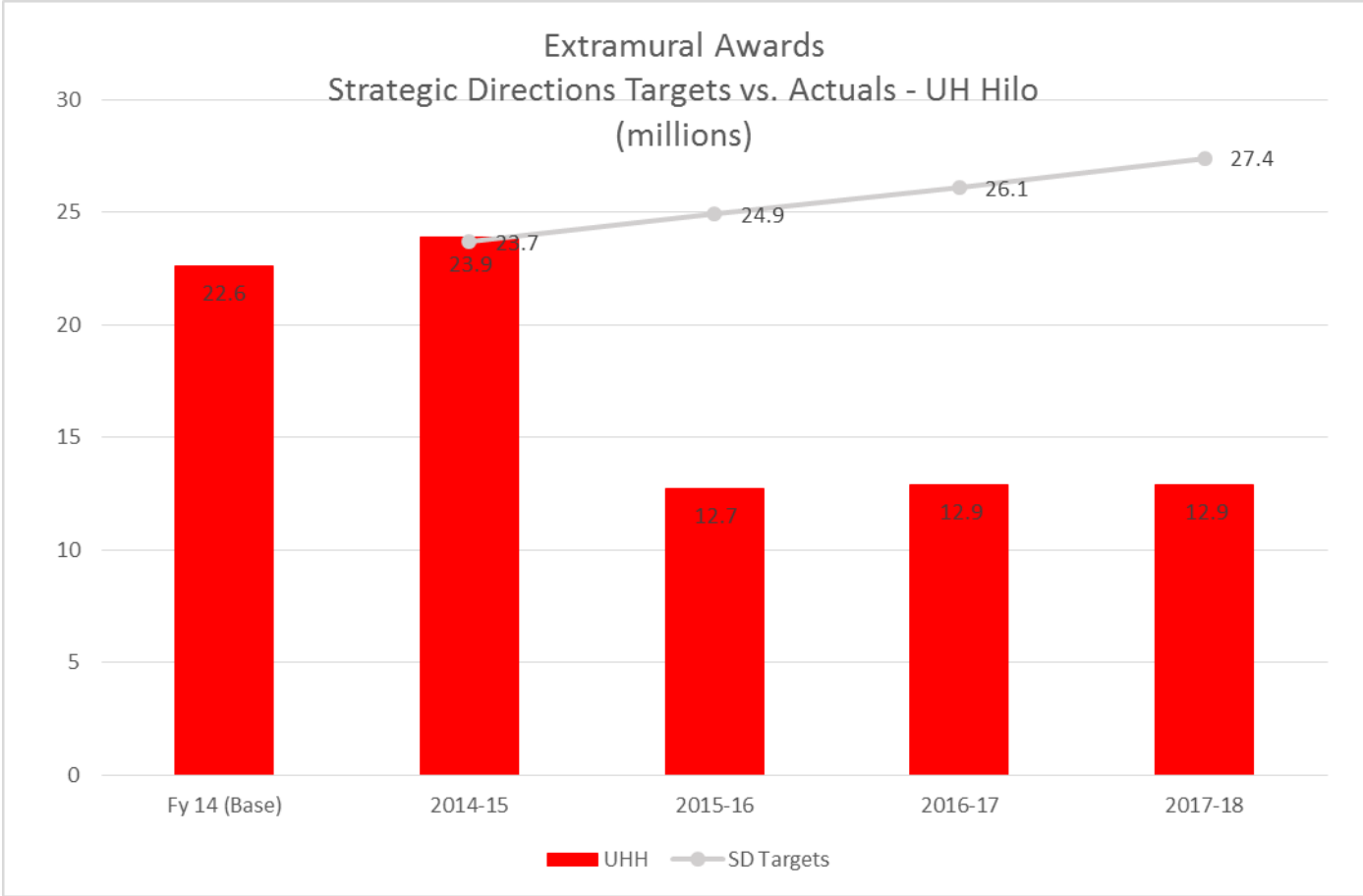

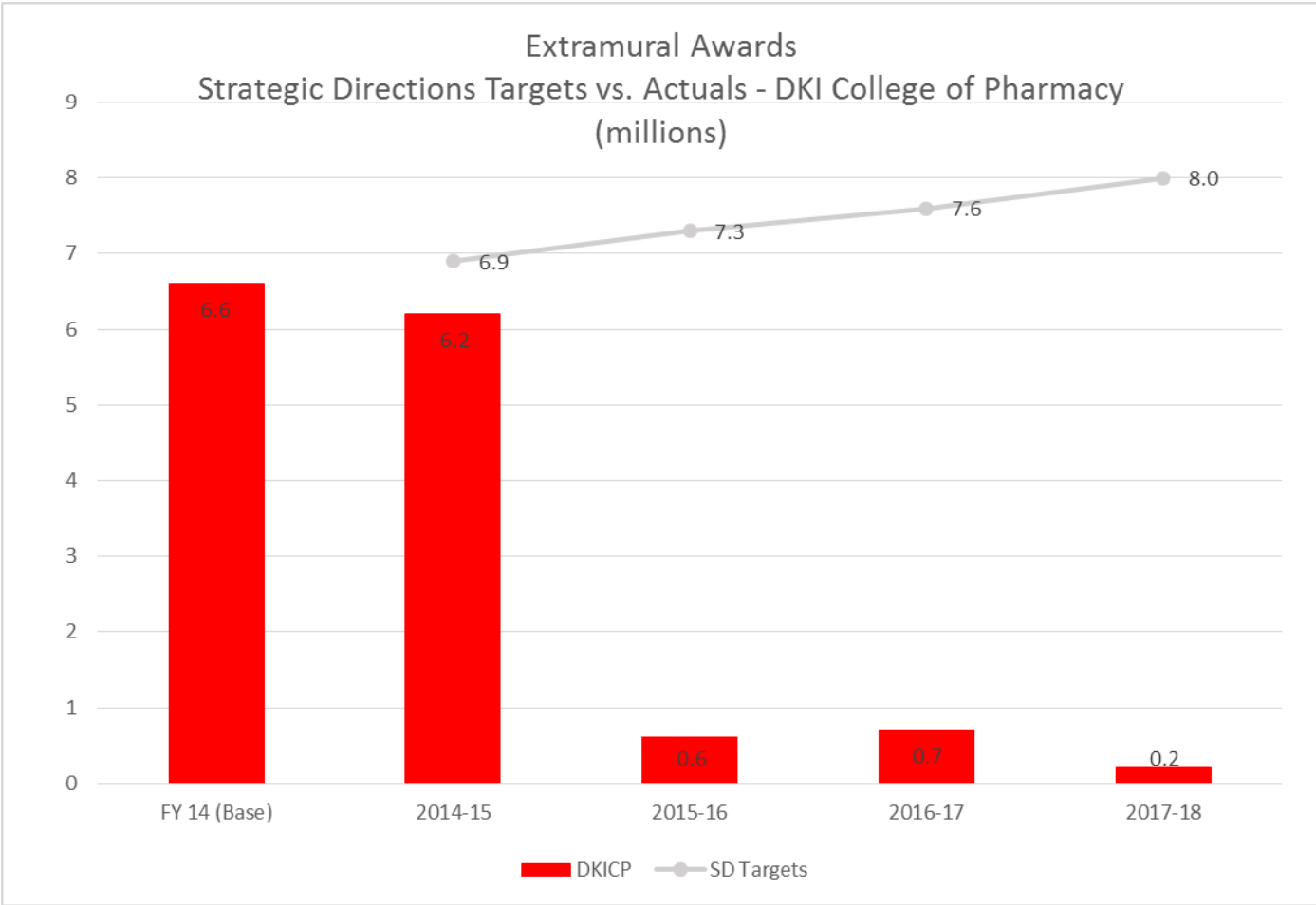

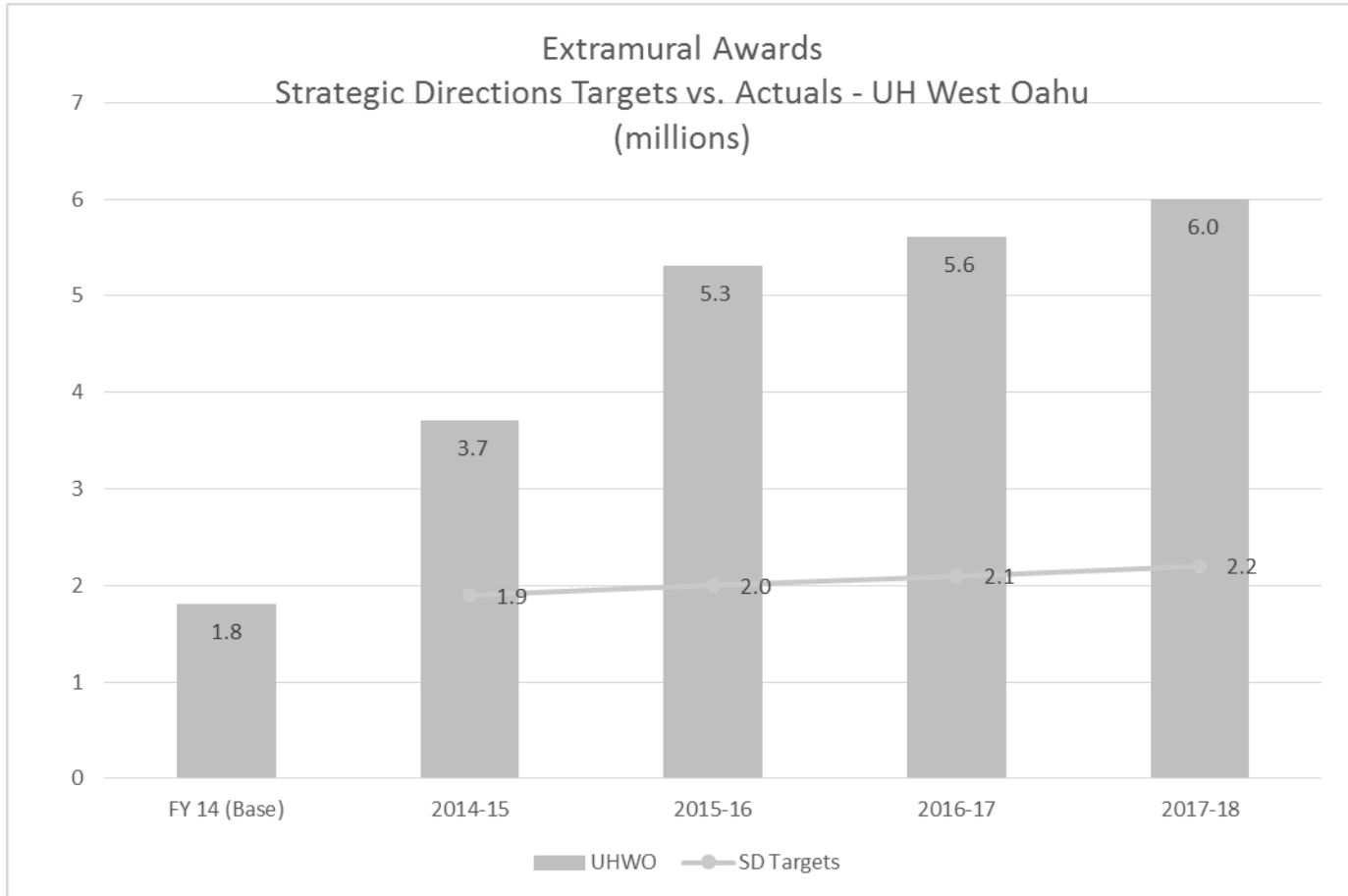

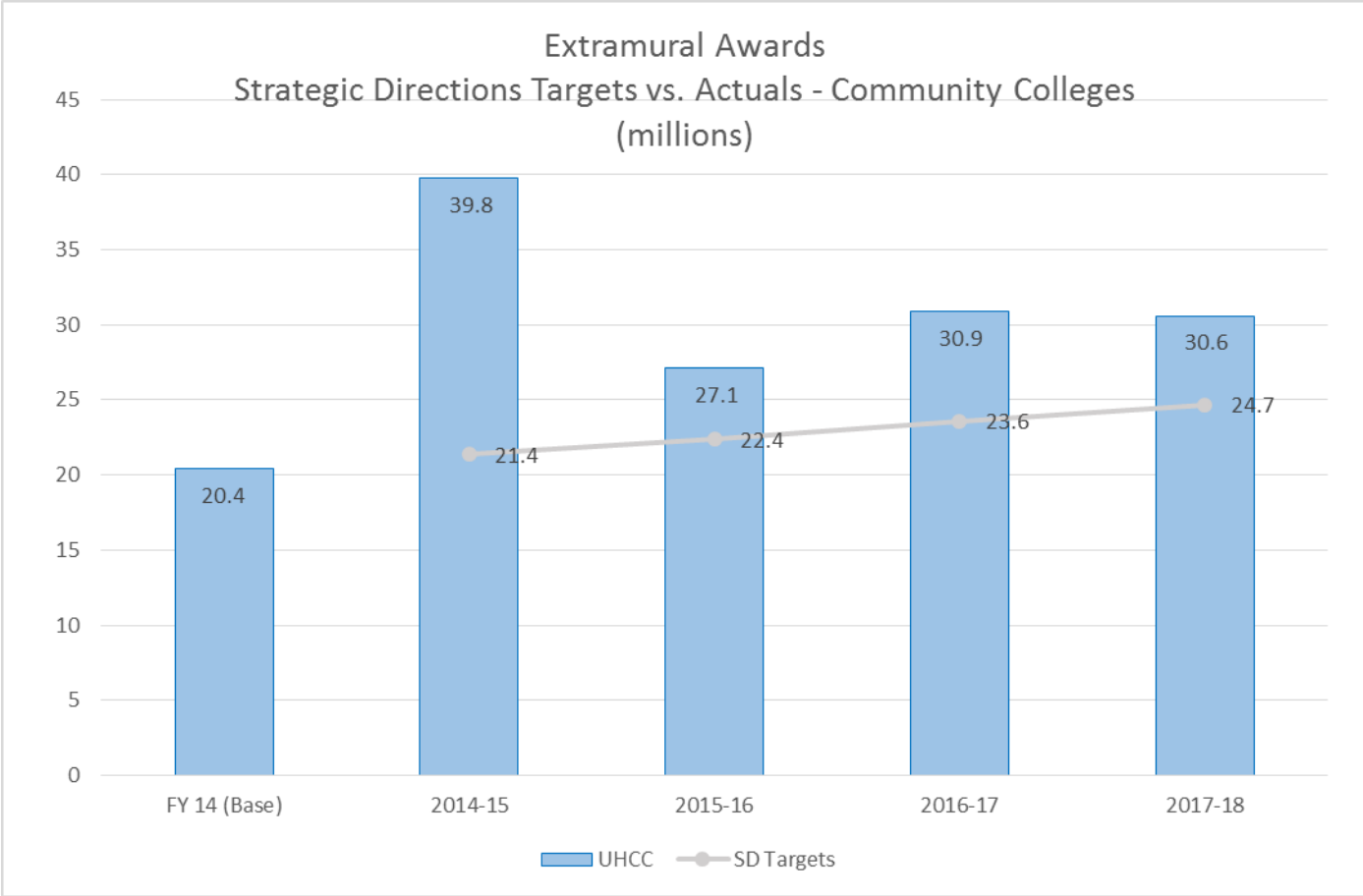

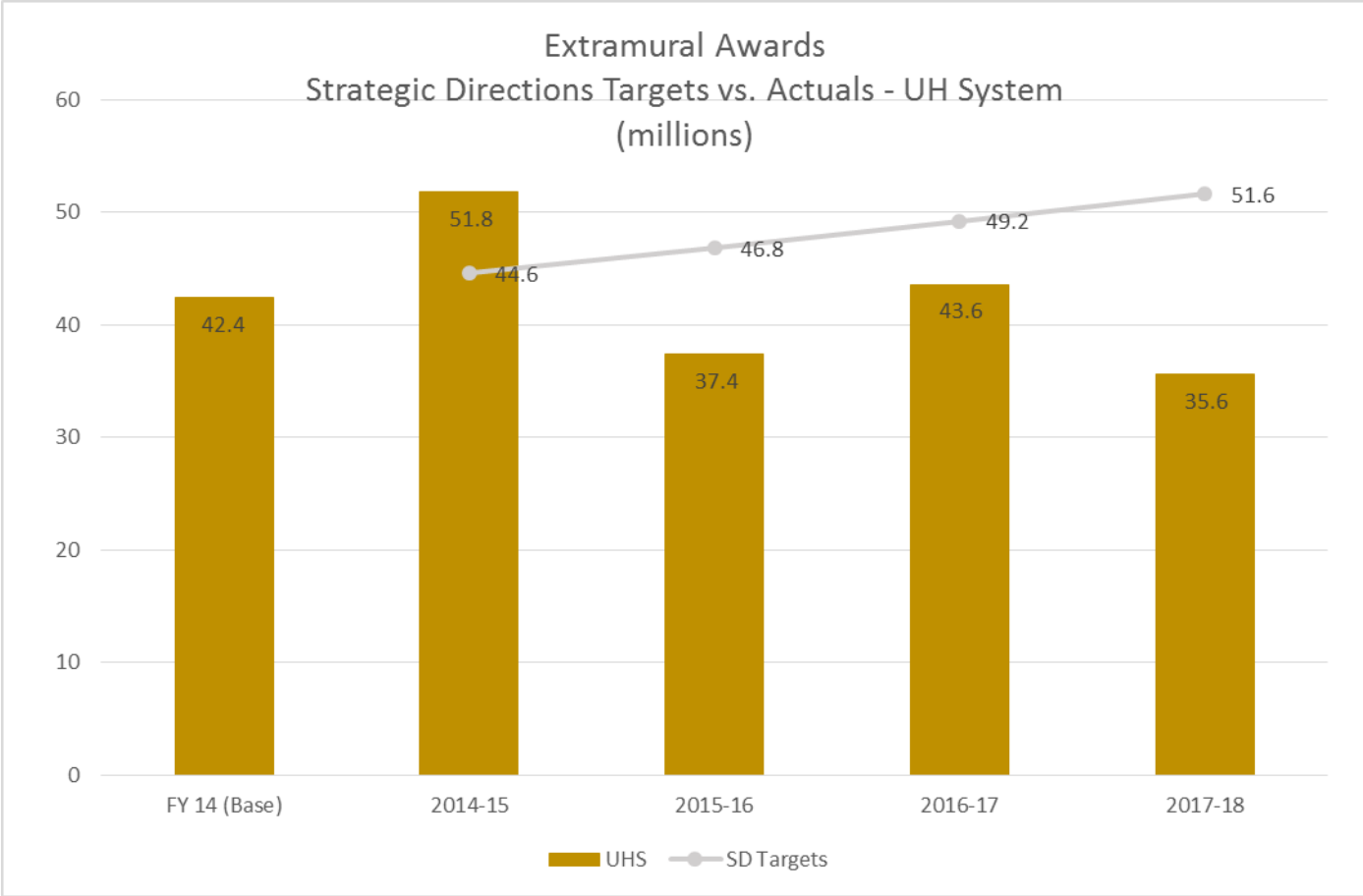

# APPENDIX



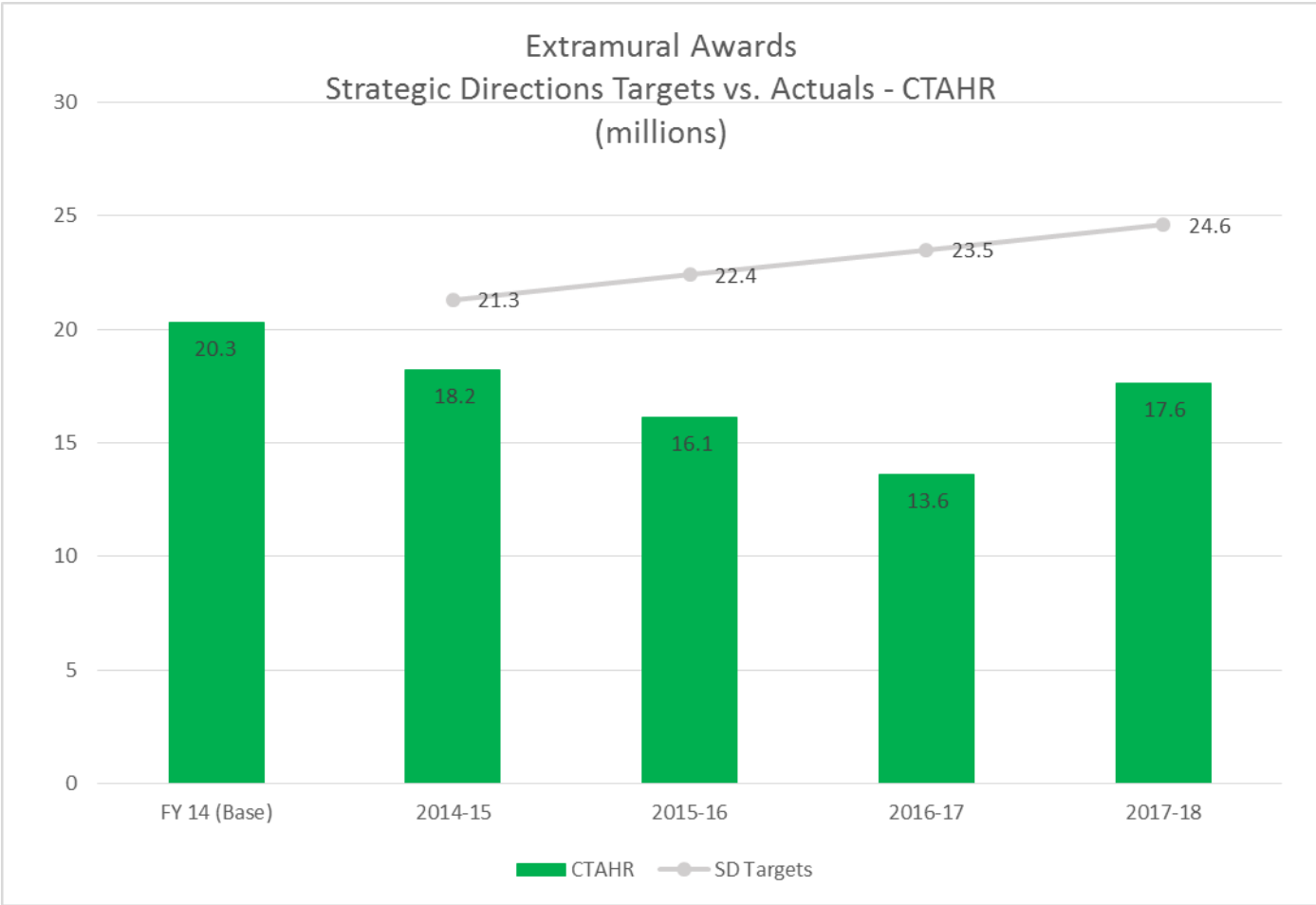



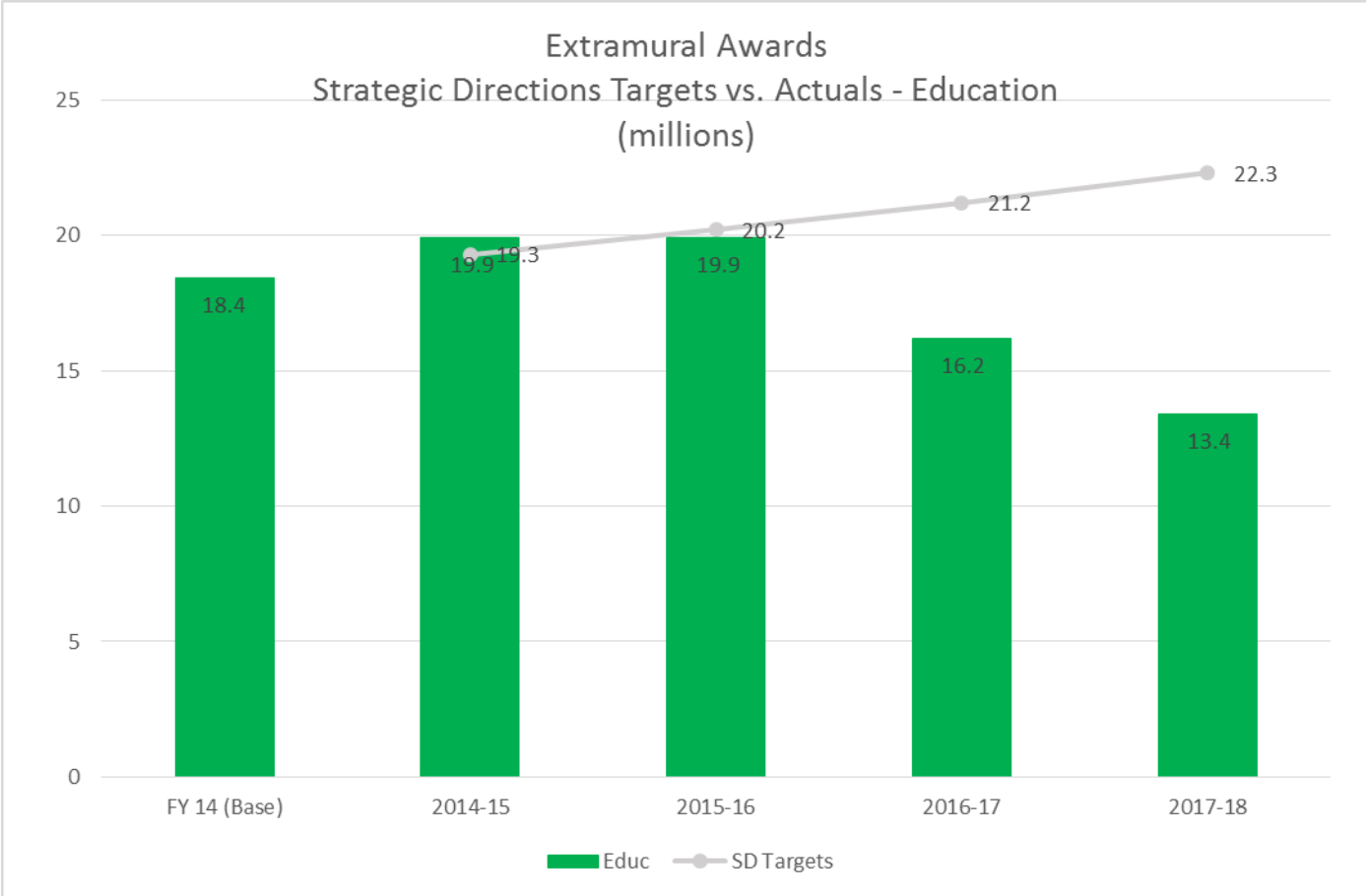

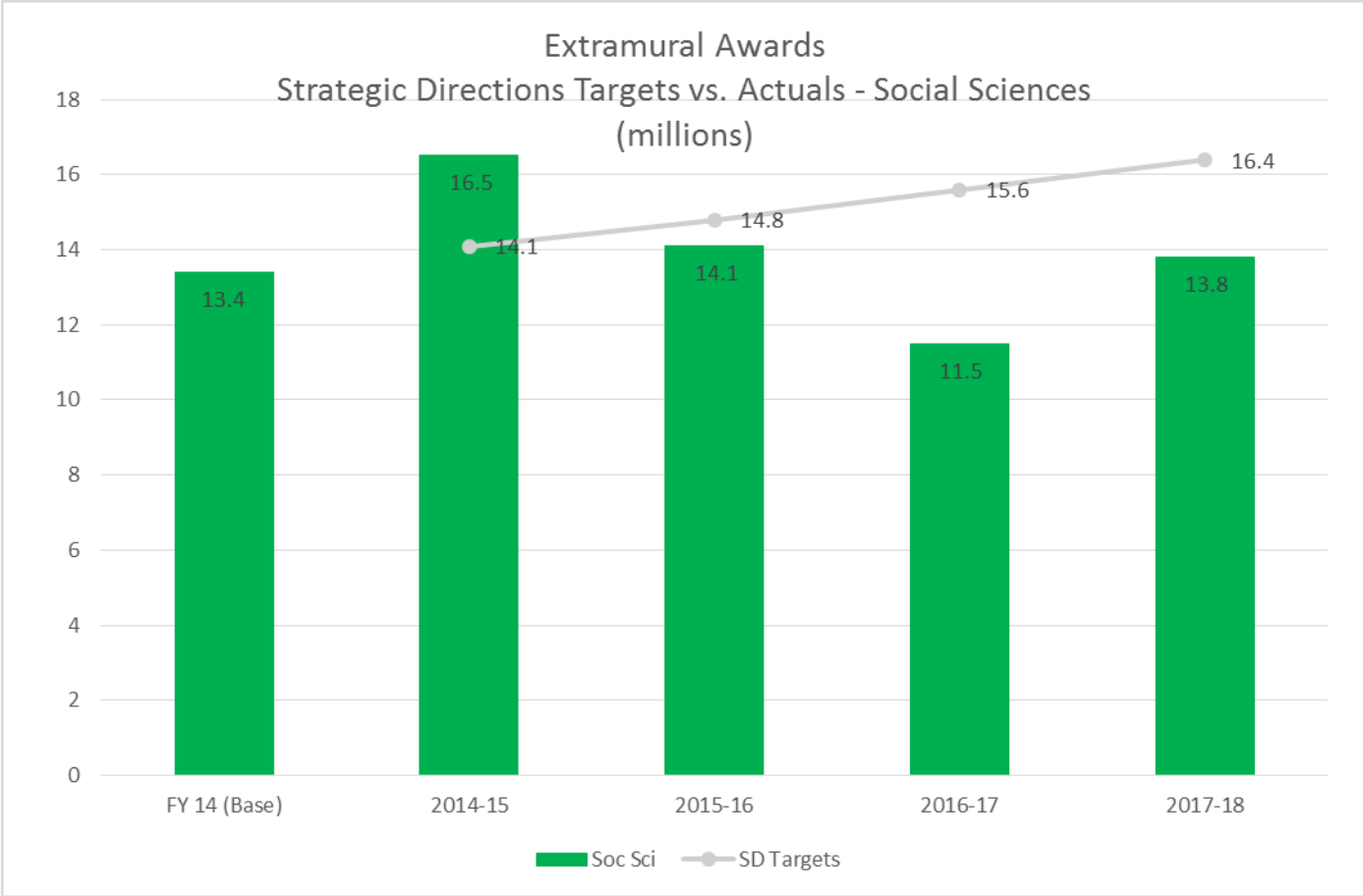



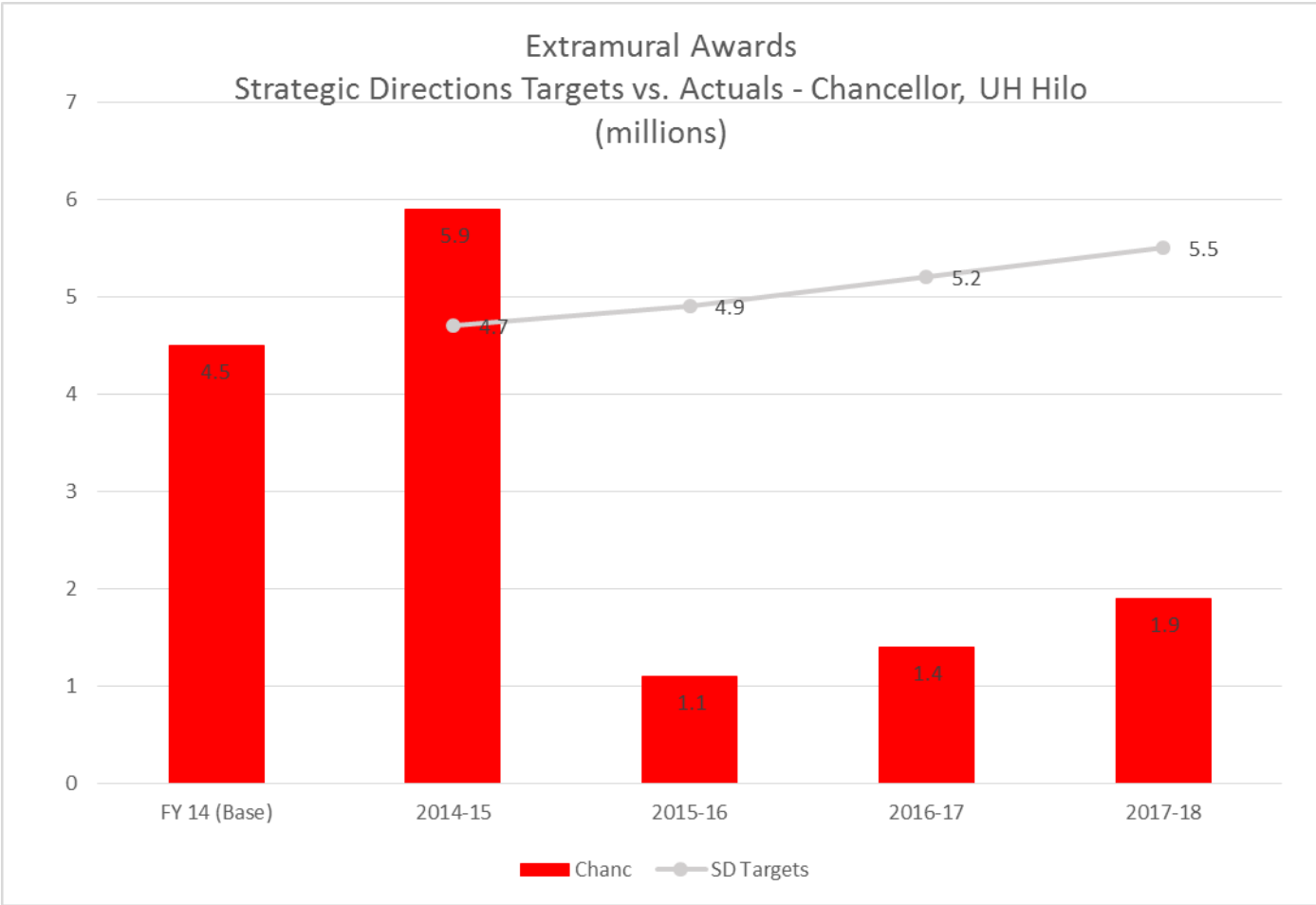

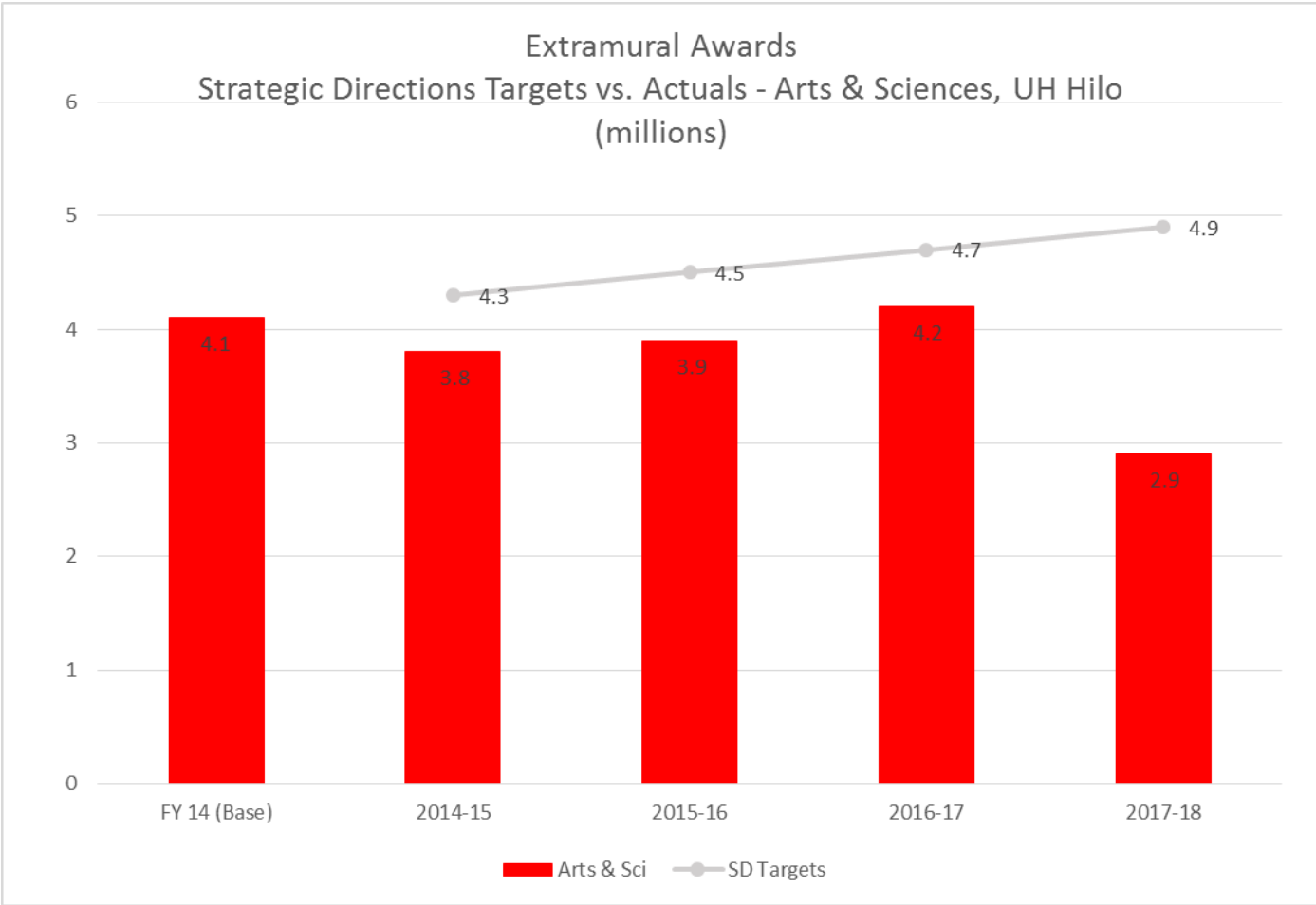

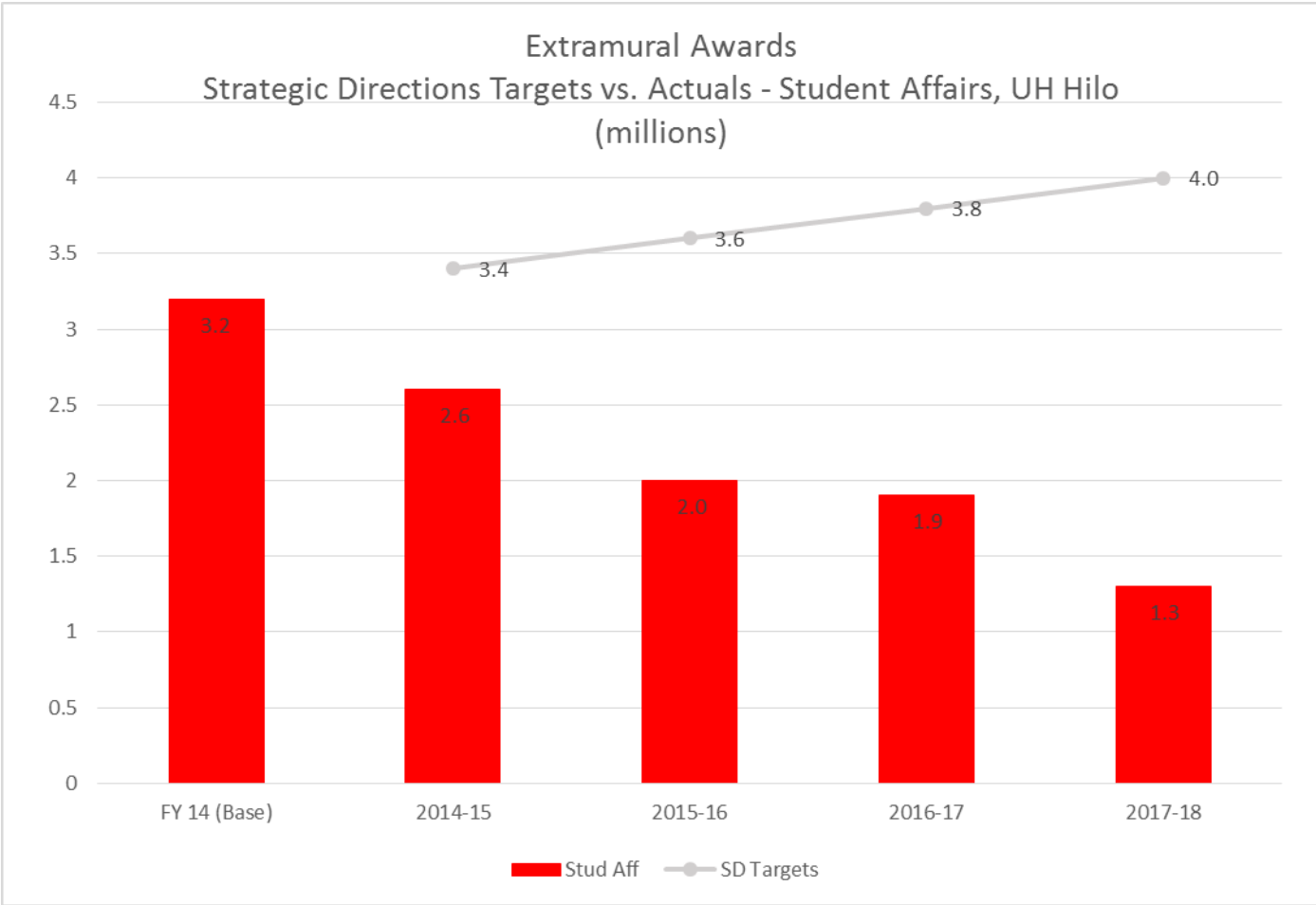

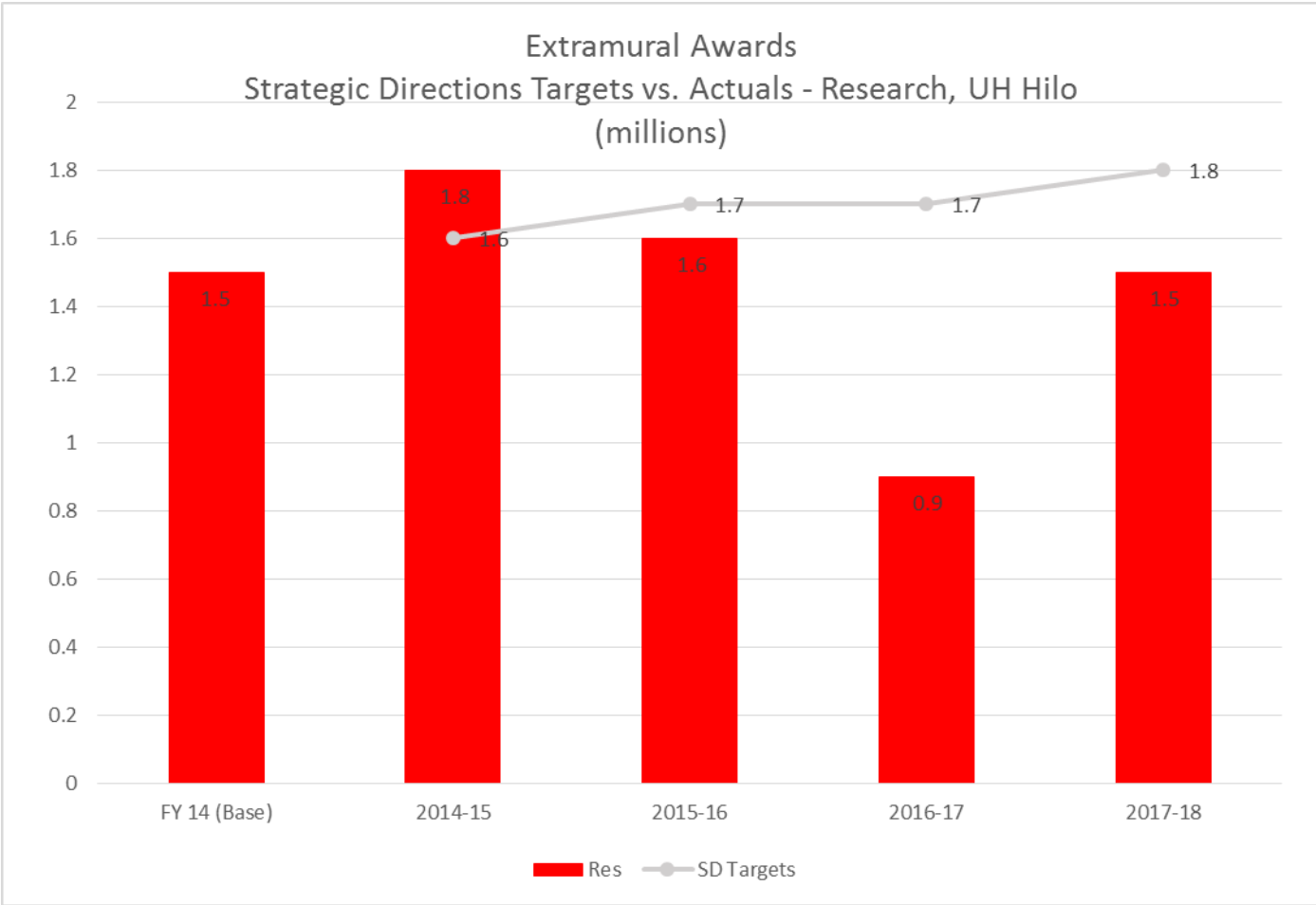

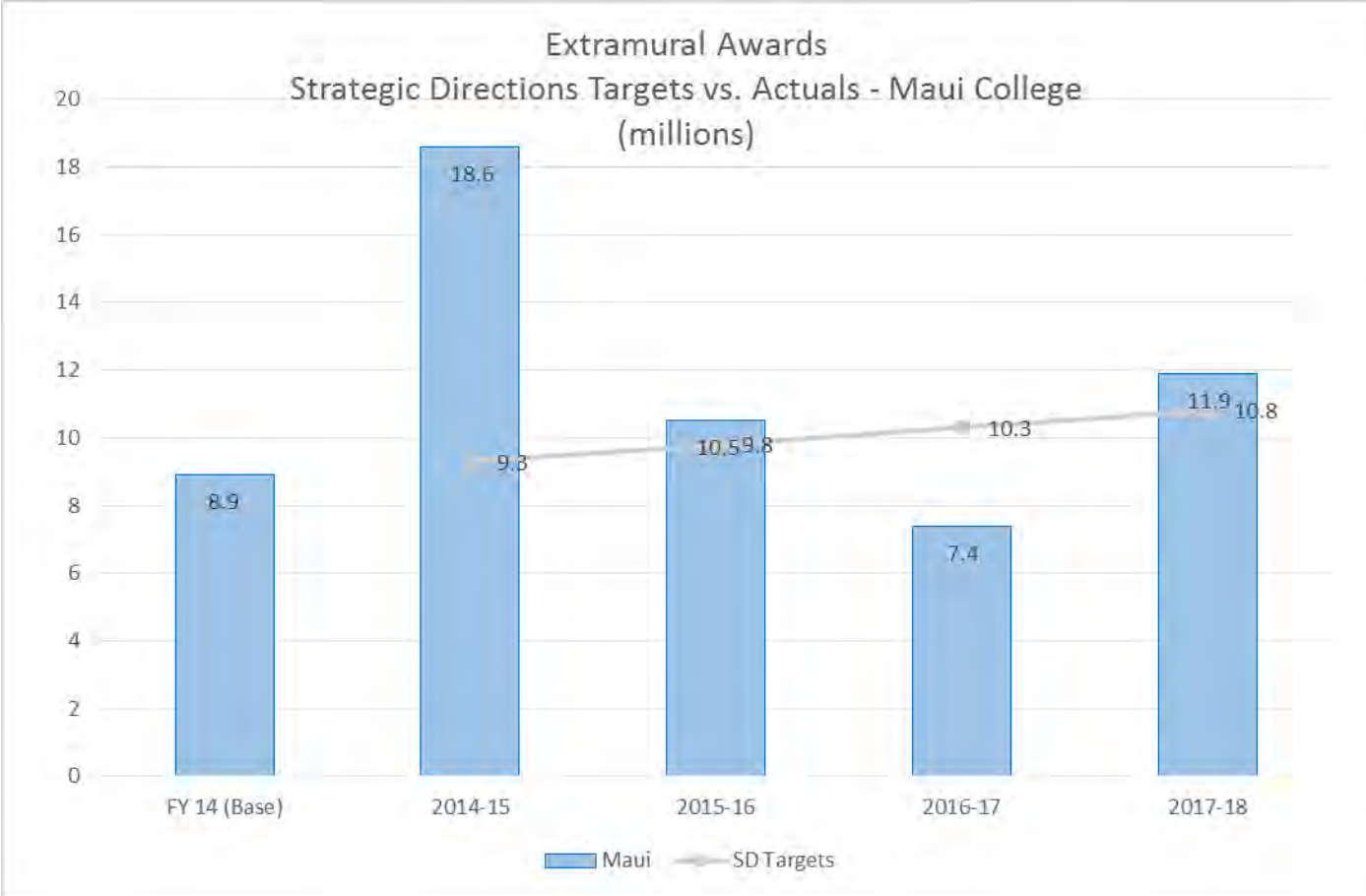



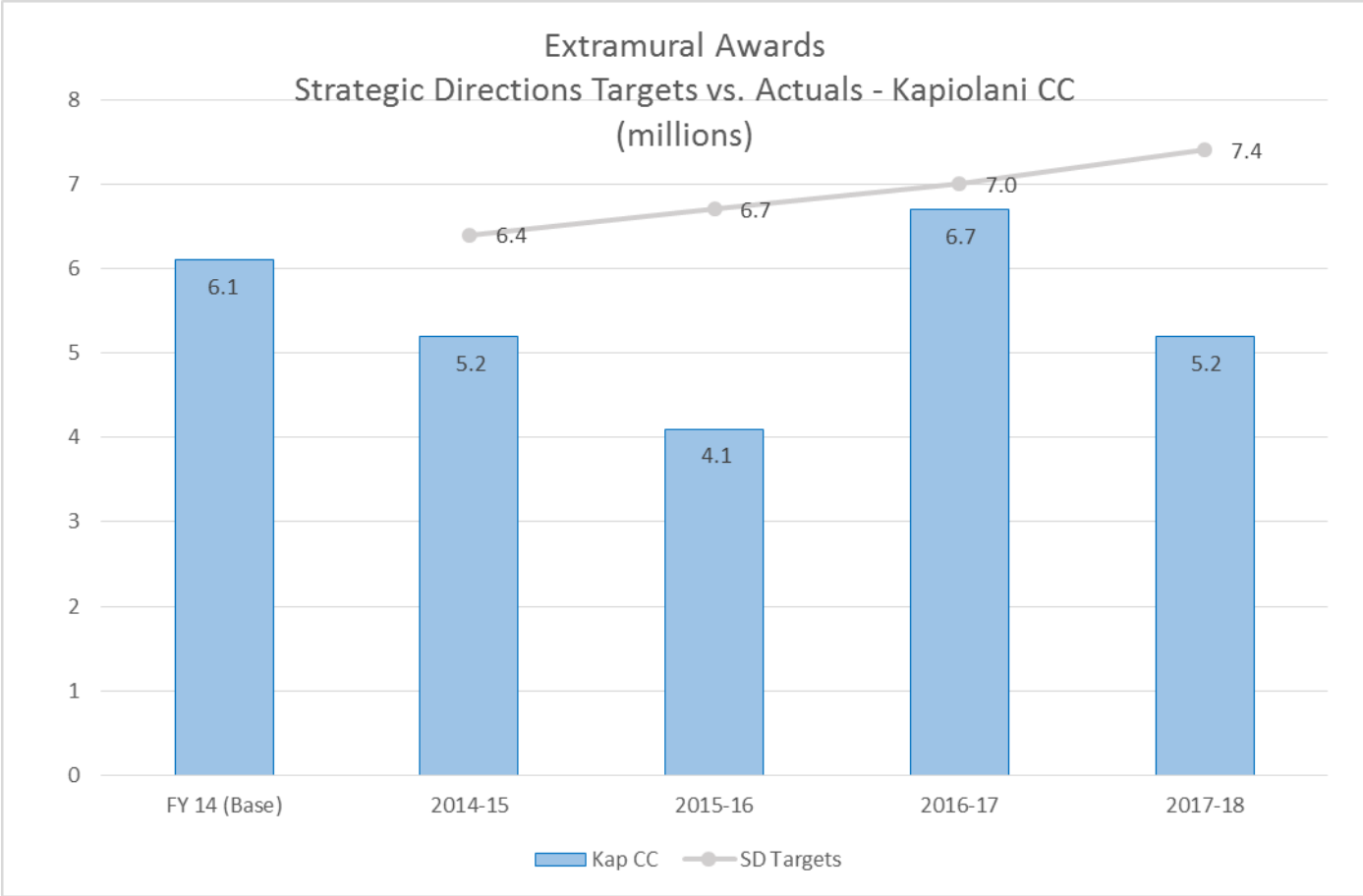

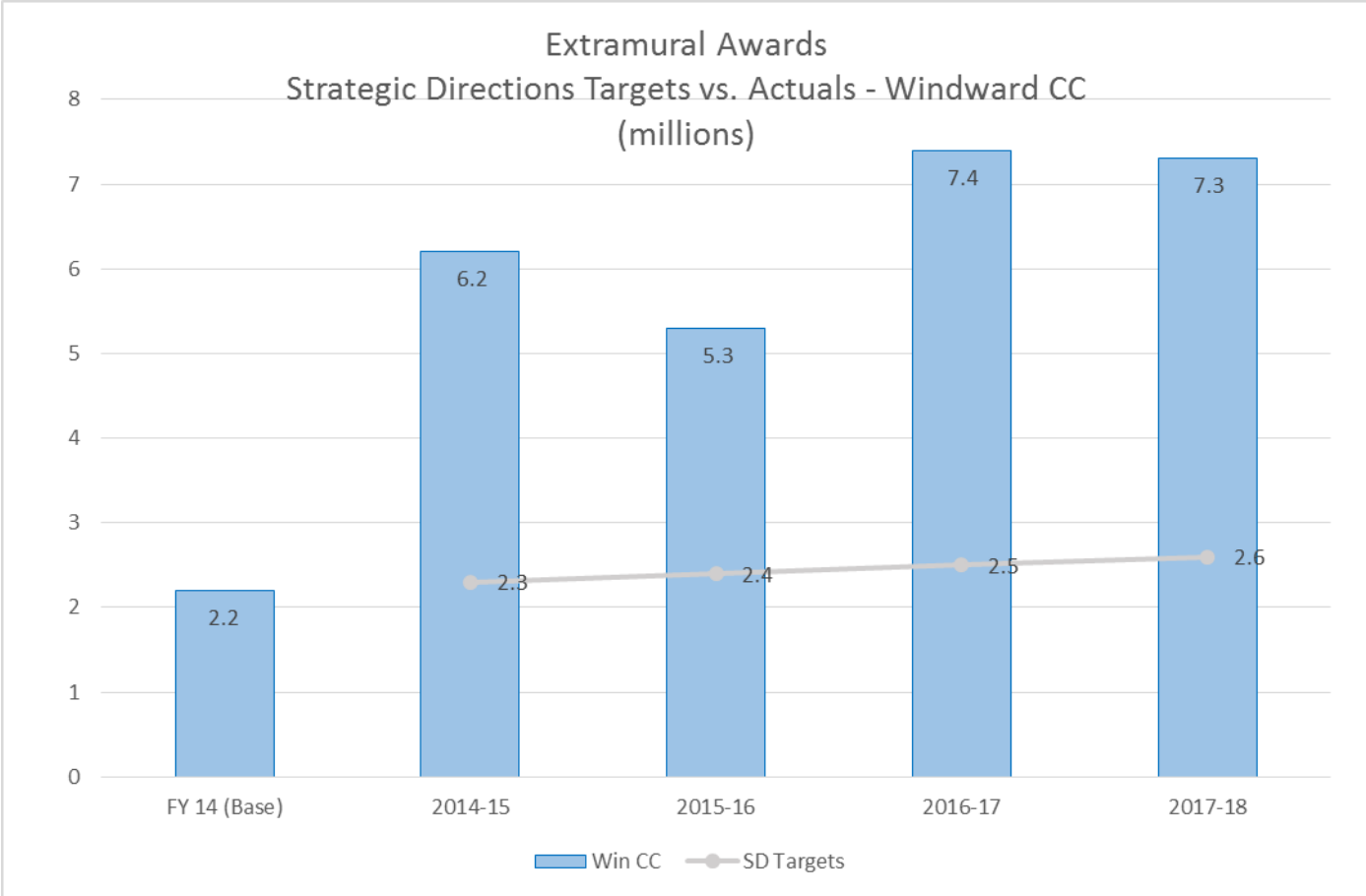

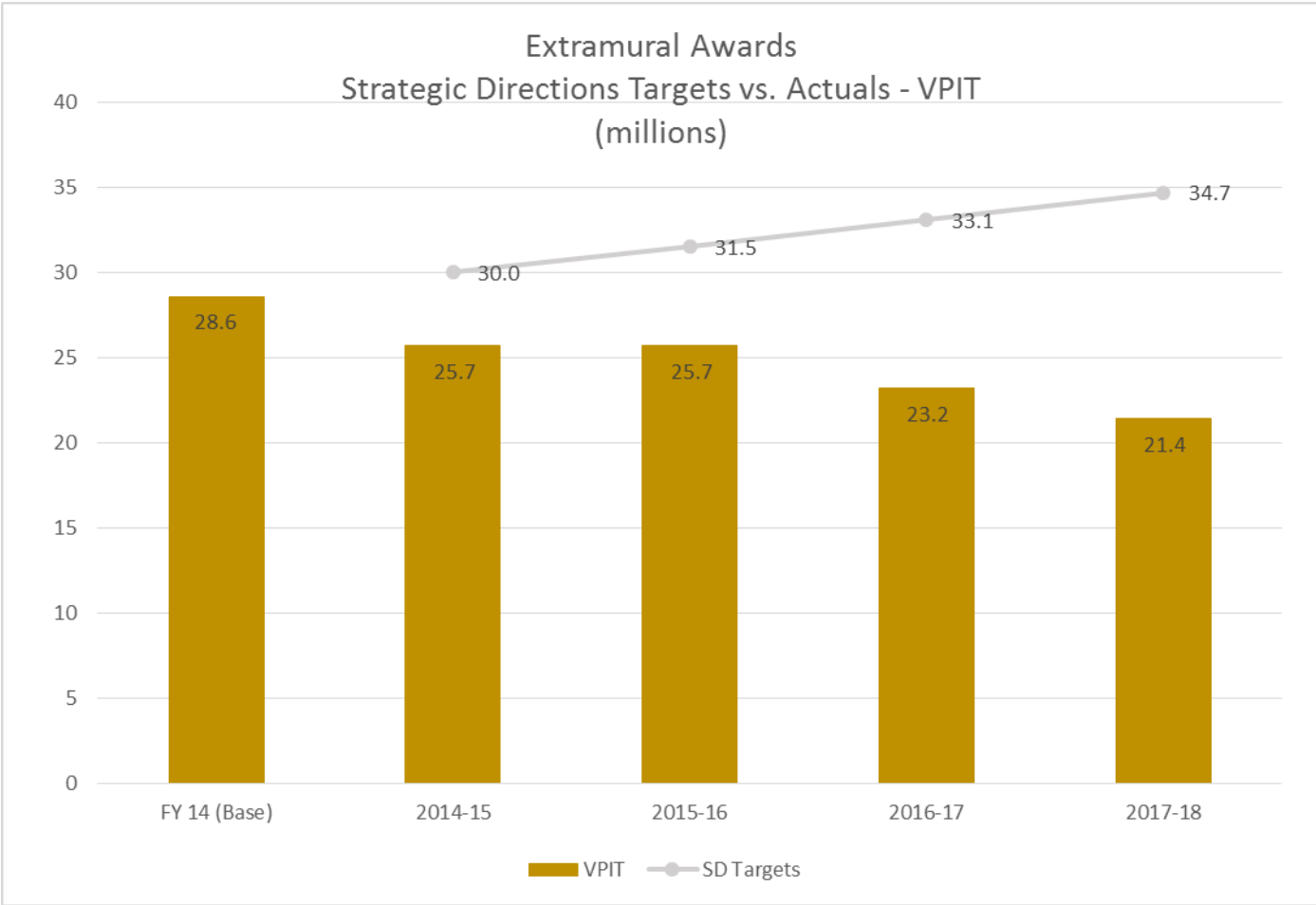

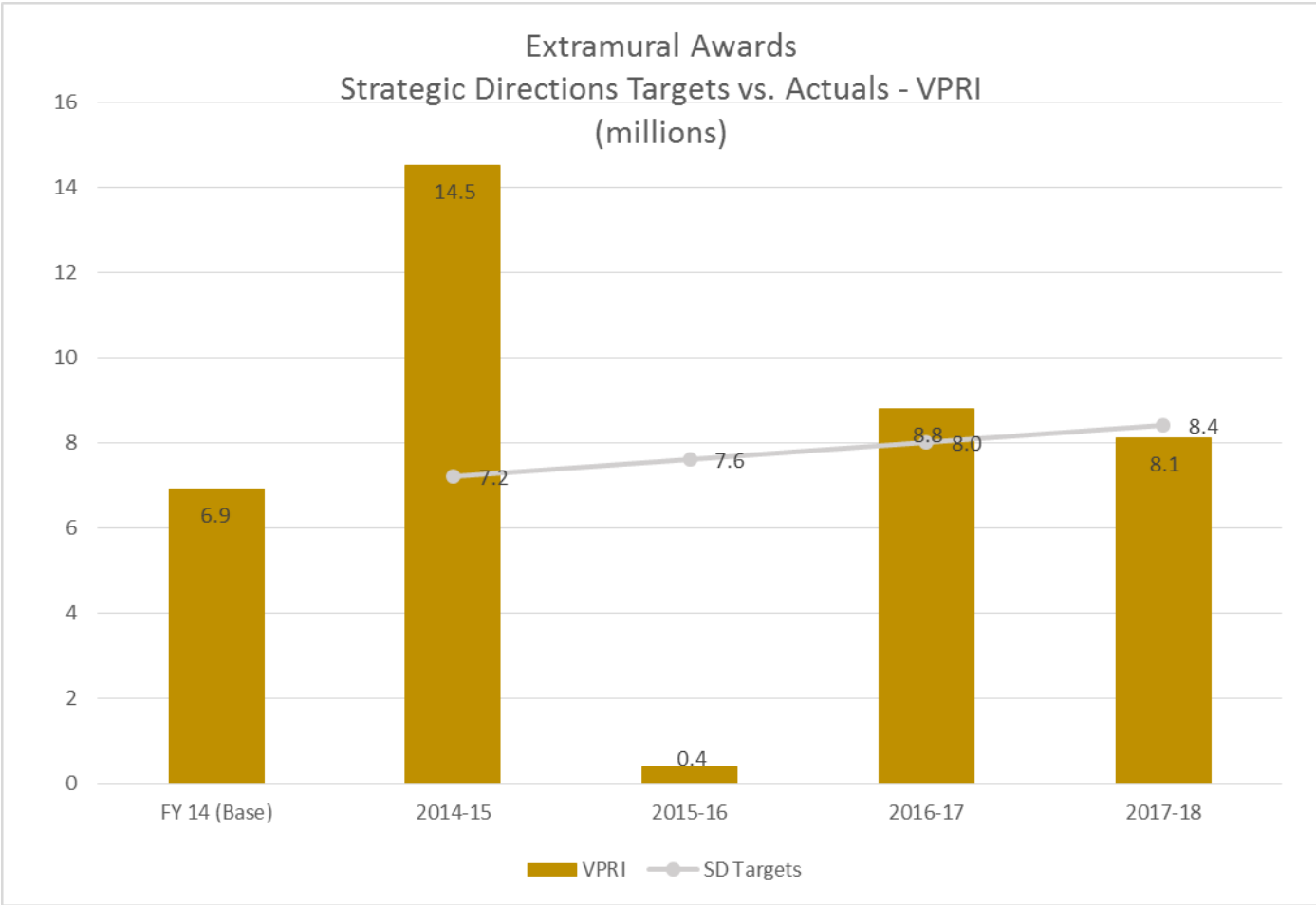

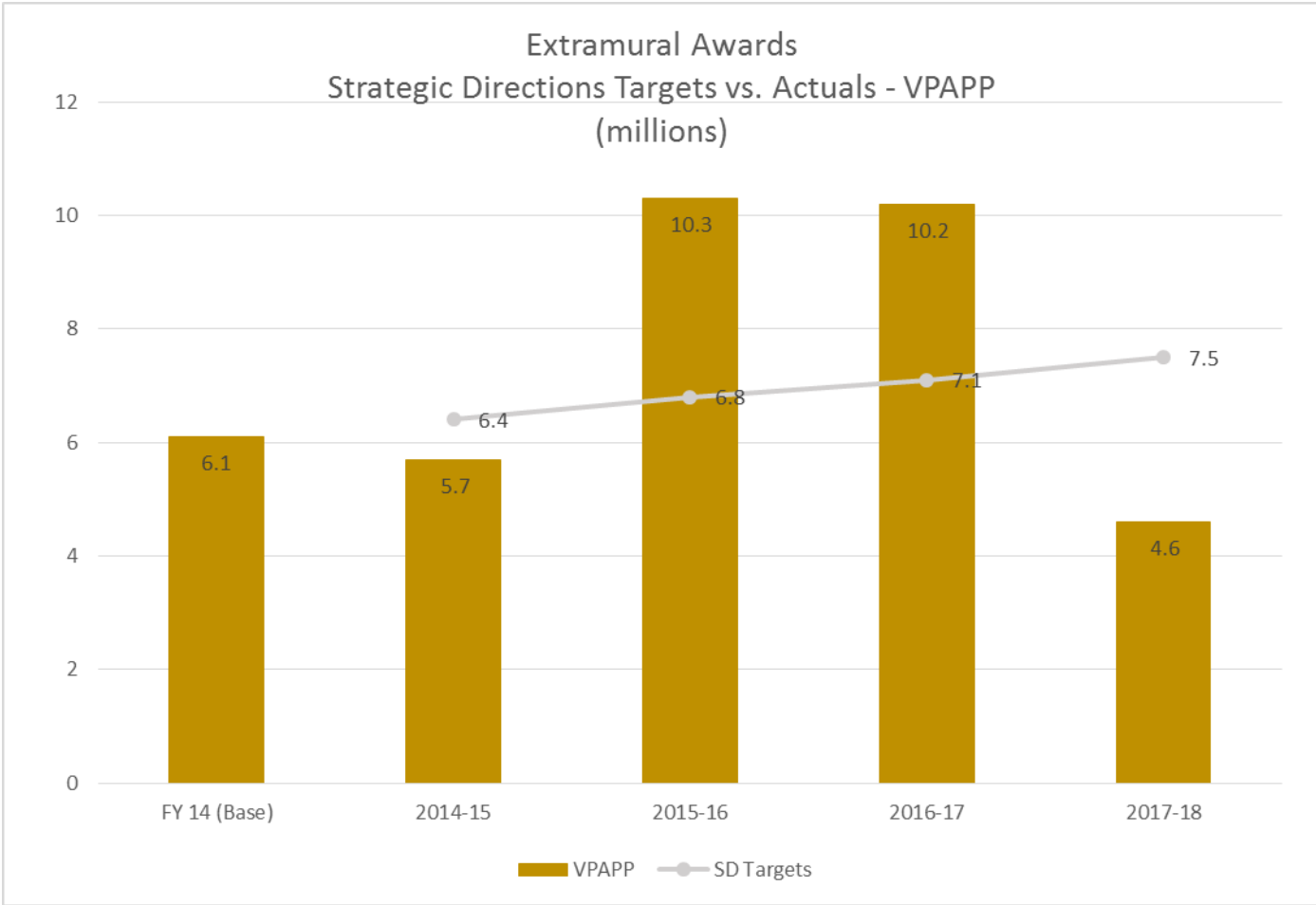

# Research Faculty: Current Hiring Policy and Comparative Data

---

BOR Research & Innovation Committee



# Current Policy

---

- Effective May 16, 2017
- Signals move towards stronger integration of research and educational missions of UH Mānoa
- New “R” faculty recruitments/appointments or recruitments/appointments to fill existing “R” positions require prior approval by the Chancellor



# Current Policy

---

- Comprehensive review of the Organized Research Units
- Expectations for Research Faculty, including teaching.
- Strategic hiring, including across Organized Research Units and Academic Units





# “R” Faculty Hiring Trends

Appt Yr	I3 9/11	I4 9/11	I5 9/11	R3	R4	R5
2013	18	12	2	1	0	2
2014	20	5	7	4	1	1
2015	13	2	2	4	0	1
2016	30	3	2	3	0	0
2017	52	4	4	6	0	0
2018	39	4	3	1	3	1

I – Instructor; R – Researcher (Number identifies rank)  
 9/11 – Includes both 9 and 11-month appointments



# How do we compare?

---

- Florida Solar Energy Center, University of Central Florida
  - Created by the Florida Legislature in 1975
  - photovoltaics, electric vehicles, smart grid technology, energy efficient buildings, alternative transportation fuels, tech transfer & education.
  - Receives \$3 million in state operating funds
  - Five-year average extramural funding = \$7.9 million
  - Ratio of Extramural/State funds = 2.6



# How do we compare?

---

- Institute for Geophysics, University of Texas
  - Founded in 1972
  - 50 employees
  - climate, energy, marine geosciences & tectonics, and planetary & polar geophysics.
  - Receives \$2 million in state operating funds and \$9 million in extramural
  - Ratio of Extramural/State funds = 4.5



# How do we compare?

---

- Rutgers Coastal Ocean Observational Lab
  - Leading university in the development and utilization of unmanned underwater systems, high frequency RADAR systems, and high-resolution ocean and weather computer forecast systems.
  - Funding from NSF, NOAA, ONR, others
  - 36 employees, including 5 faculty assigned to the Lab
  - Approximately \$9 million in extramural funding in FY15
  - University funding:
    - 9-month salaries for 5 faculty. These faculty all teach 2+ courses/yr
    - 12-month salaries for 2 administrative support staff
    - Average of 2 post-doctoral scholars per year
    - Minimum return of 10% IC (can be as high as 30%)



# How do we compare?

---

- University of California Observatories
  - Operates the Lick Observatory on behalf of all UC campuses
  - Designs and fabricates instrumentation for Lick and Keck Observatories
  - Facilitates UG & G instruction and PhD training throughout the UC system
  - Located on the UC Santa Cruz campus
  - 190 employees
  - Extramural funding: \$11 million/year average over 5 years (2006-2010)
  - 100% State support for core staff (7 engineers, 15 staff specialists)
  - 100% State support for 14 tenure-track faculty: 80%/20%
    - 80% support via UCO budget (Office of the President)
    - 20% support via UC Santa Cruz budget in return for teaching 1 class per year in the UCSC Department of Astronomy & Astrophysics



# Comparative ORU Ratios

---

## Extramural Funds/State Funds Ratios

*Data previously presented on May 17, 2016*

Unit	FY 2013	FY 2014	FY 2015
School of Ocean, Earth Science & Technology	3.1	3.5	3.4
Institute for Astronomy	2.0	2.1	2.0
UH Cancer Center	2.6	3.2	2.8



# How do we compare?

---

- We are not unique in providing university salary support for research faculty.
- We are not unique in having research centers that are not fully engaged in the university's educational mission, although that is changing and we will be addressing this via our Strategic Plan.
- We appear to be rather unique in providing tenure to Research faculty, although we are not alone in this regard (e.g., UCO). There are institutions (e.g., Woods Hole Oceanographic Institution) that grant tenure to grant-supported researchers.



Faculty Compensation by Funding Source:  
Selected UH Mānoa Units, FY 16 – FY 18

# APPENDIX





# Methodology

---

- BU 07, including less than 50% FTE appointments
- Level 5 unit based on apparent locus of tenure in PeopleSoft
- Object codes: 2001 – Regular Pay, 2008 - Overload and 2009 – Retro Pay from Kualii Financial System
- I(nstructional), M(edical), R(esearch) and S(pecialist) faculty
- Extramural = Federal and Non-Federal Grants and Contracts
- G-fund = General Funds
- TFSF = Tuition & Fee Special Funds
- RTRF = Research & Training Revolving Funds
- Other = All other sources



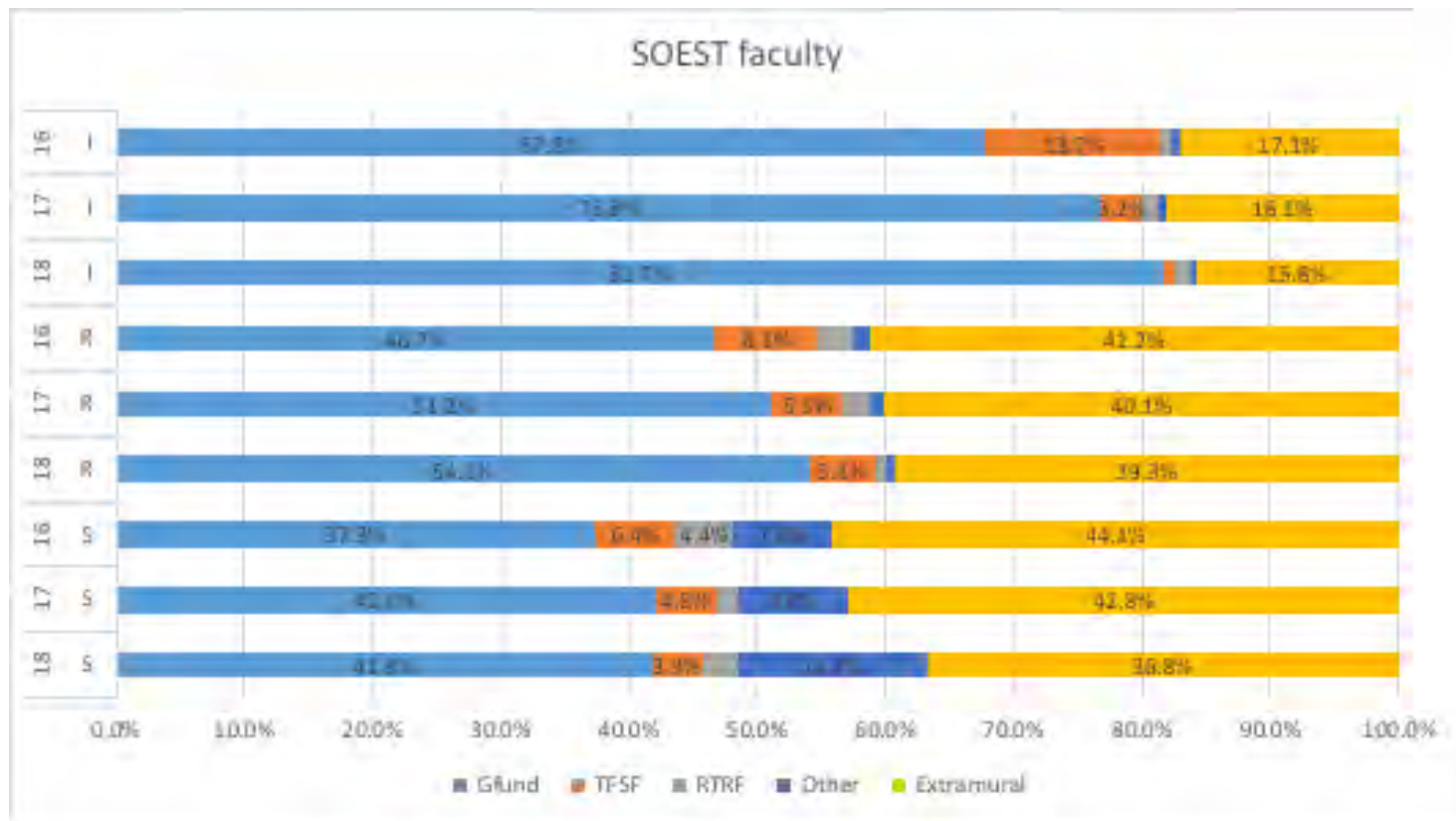

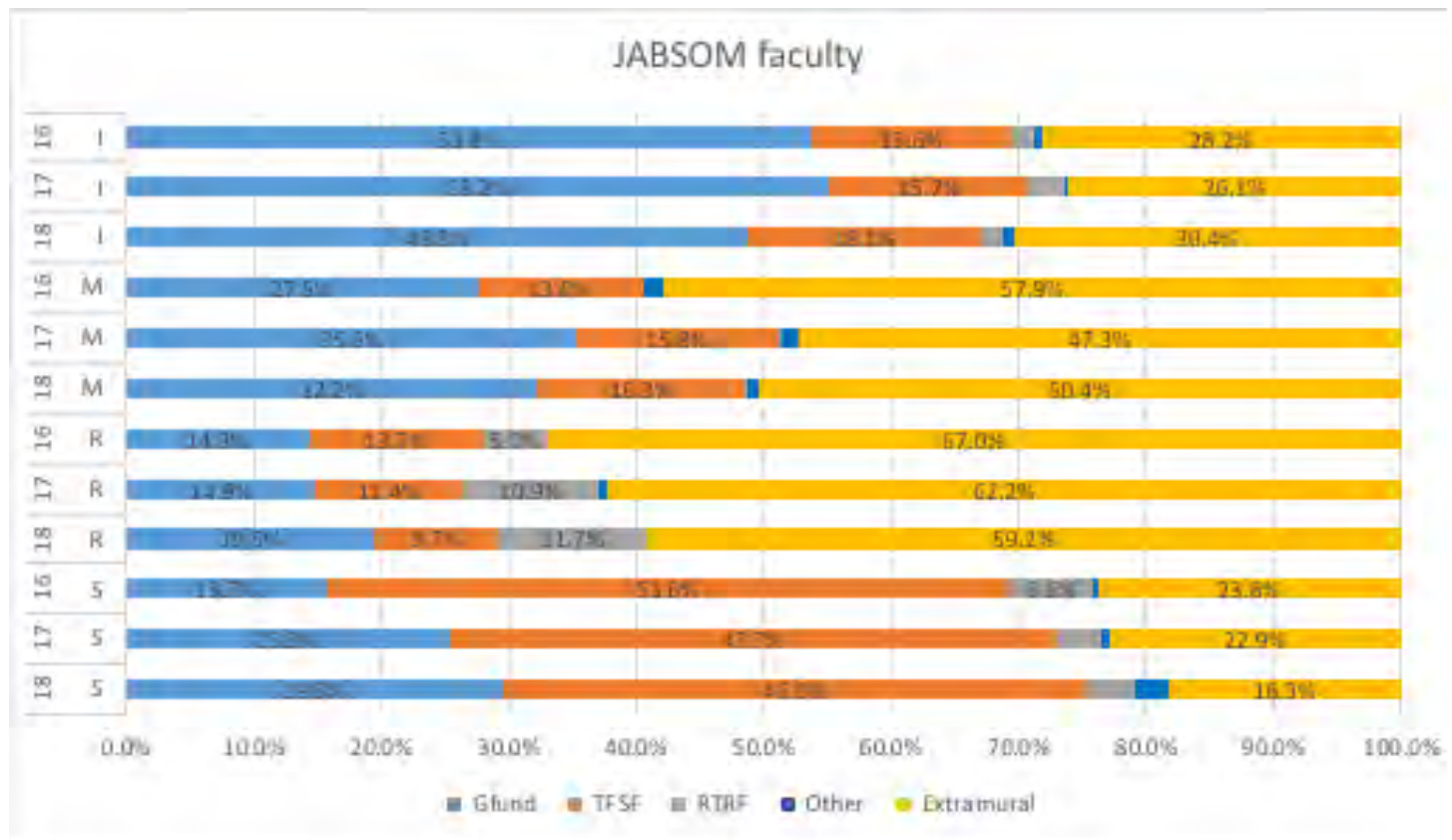

### UH Cancer Center faculty

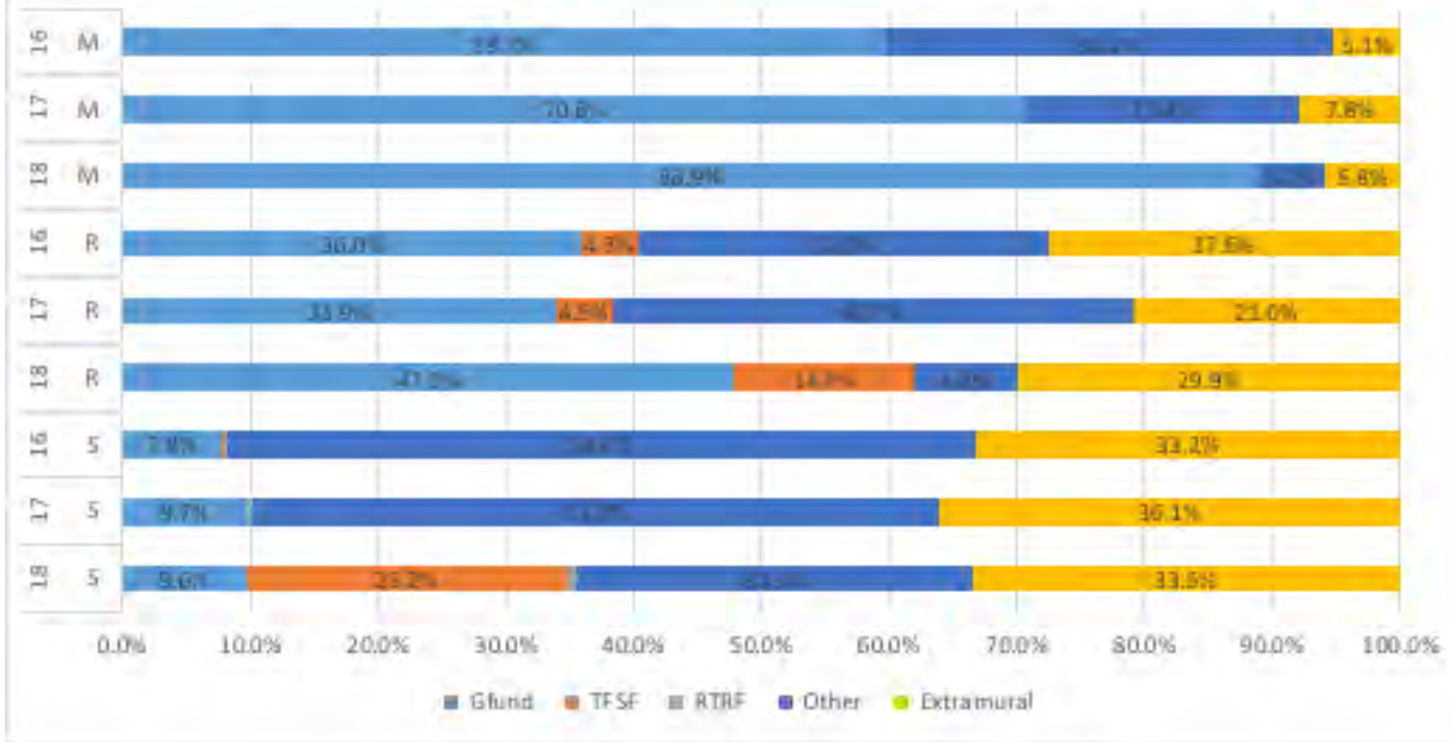

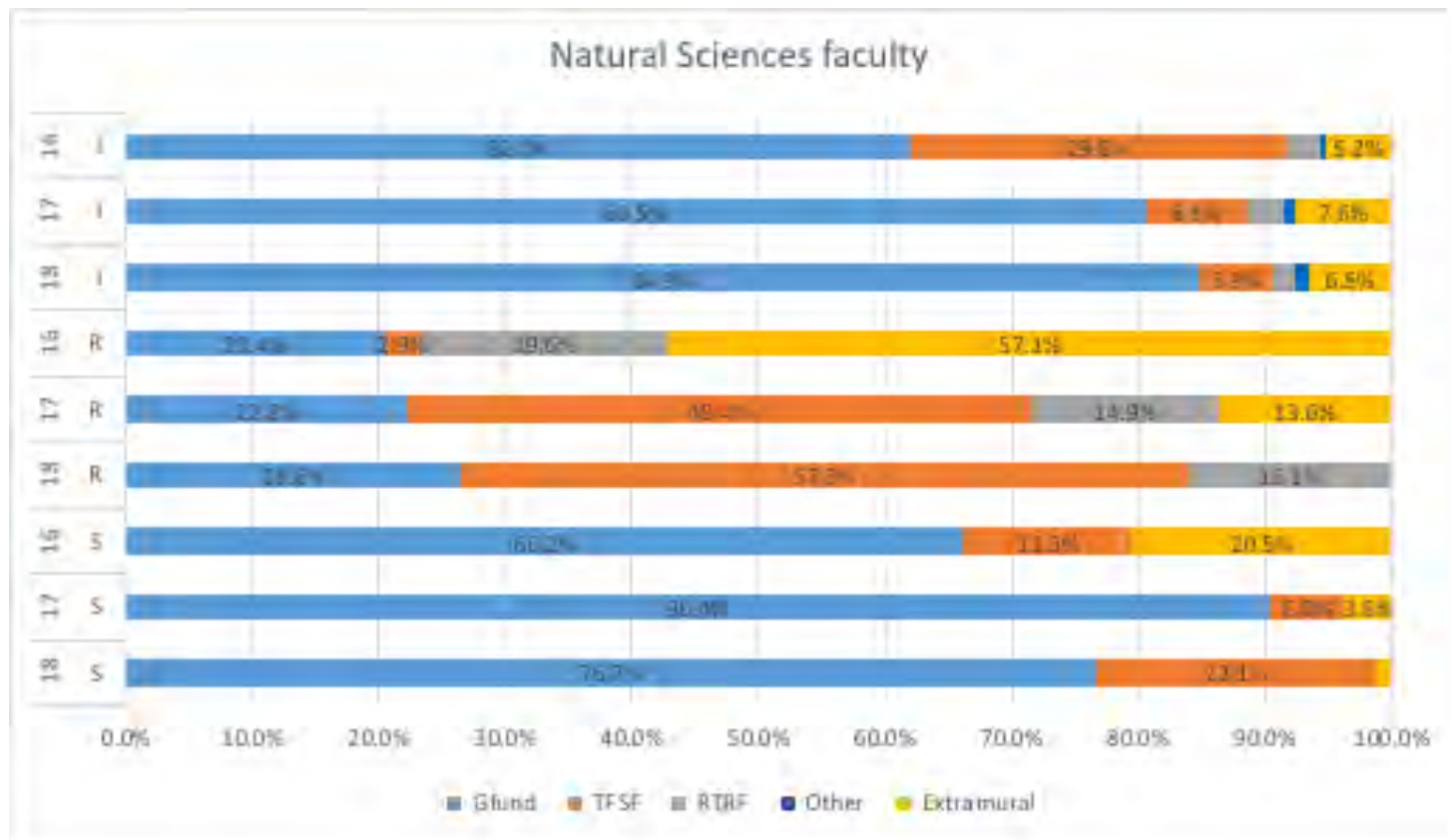

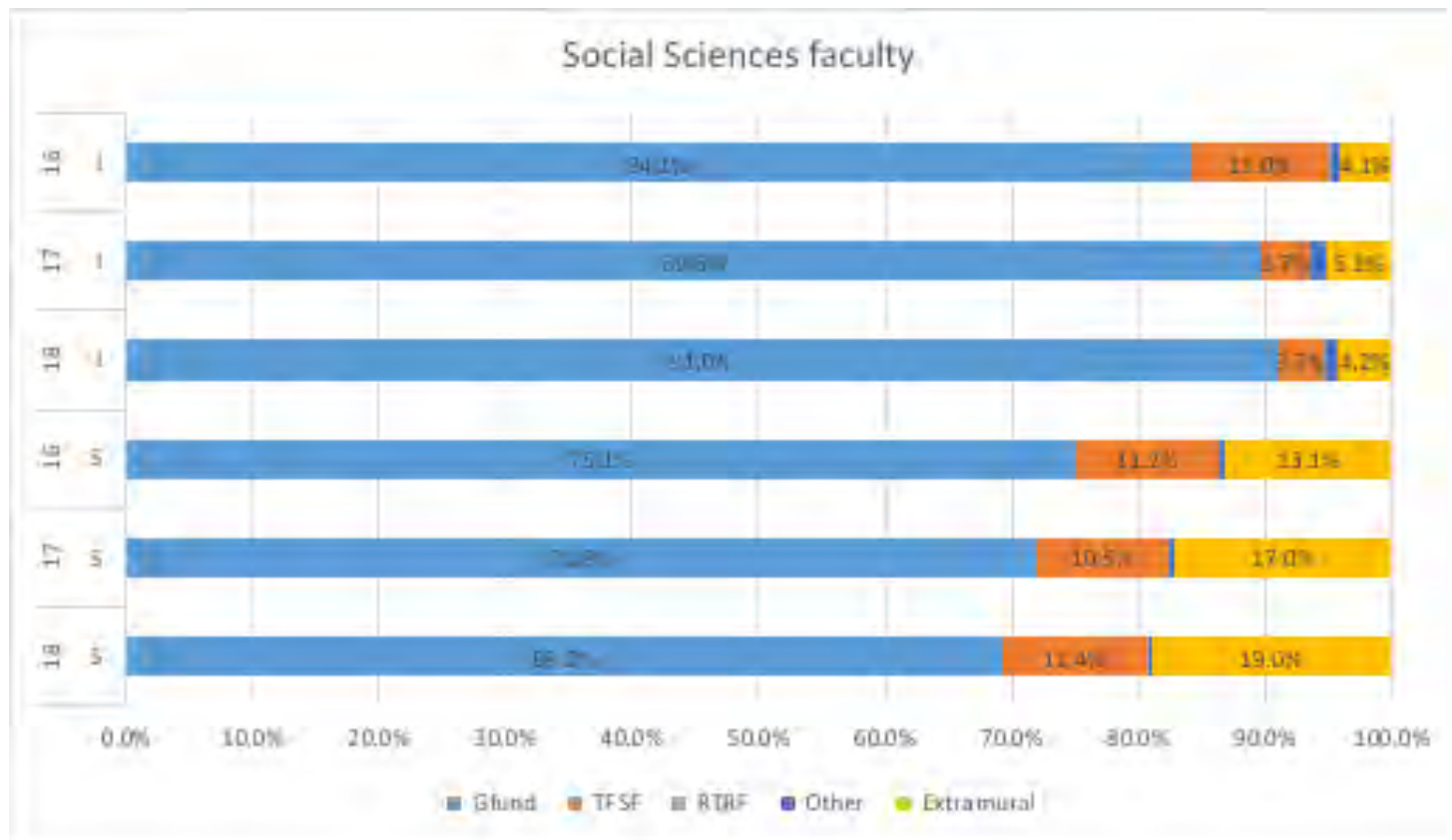

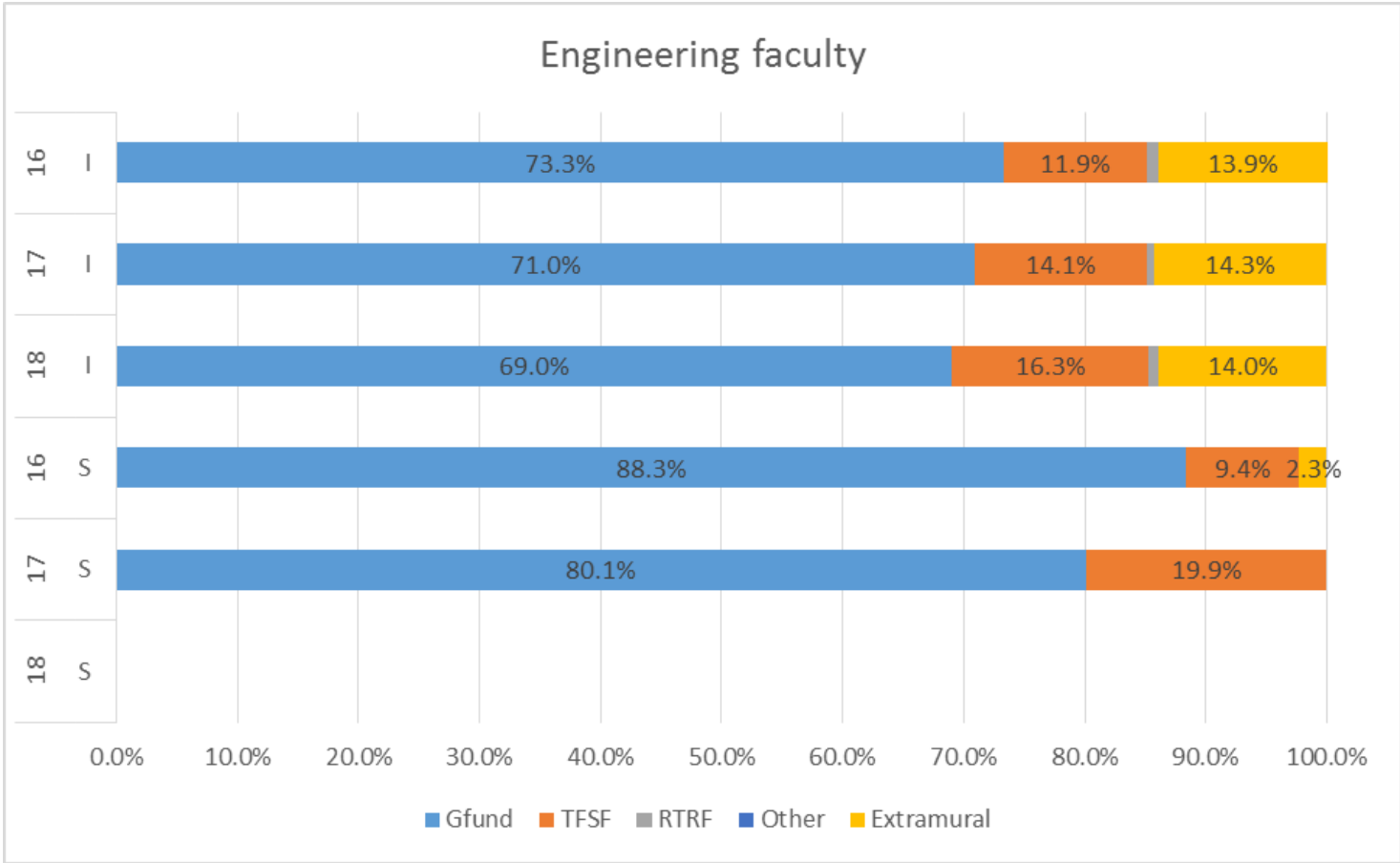

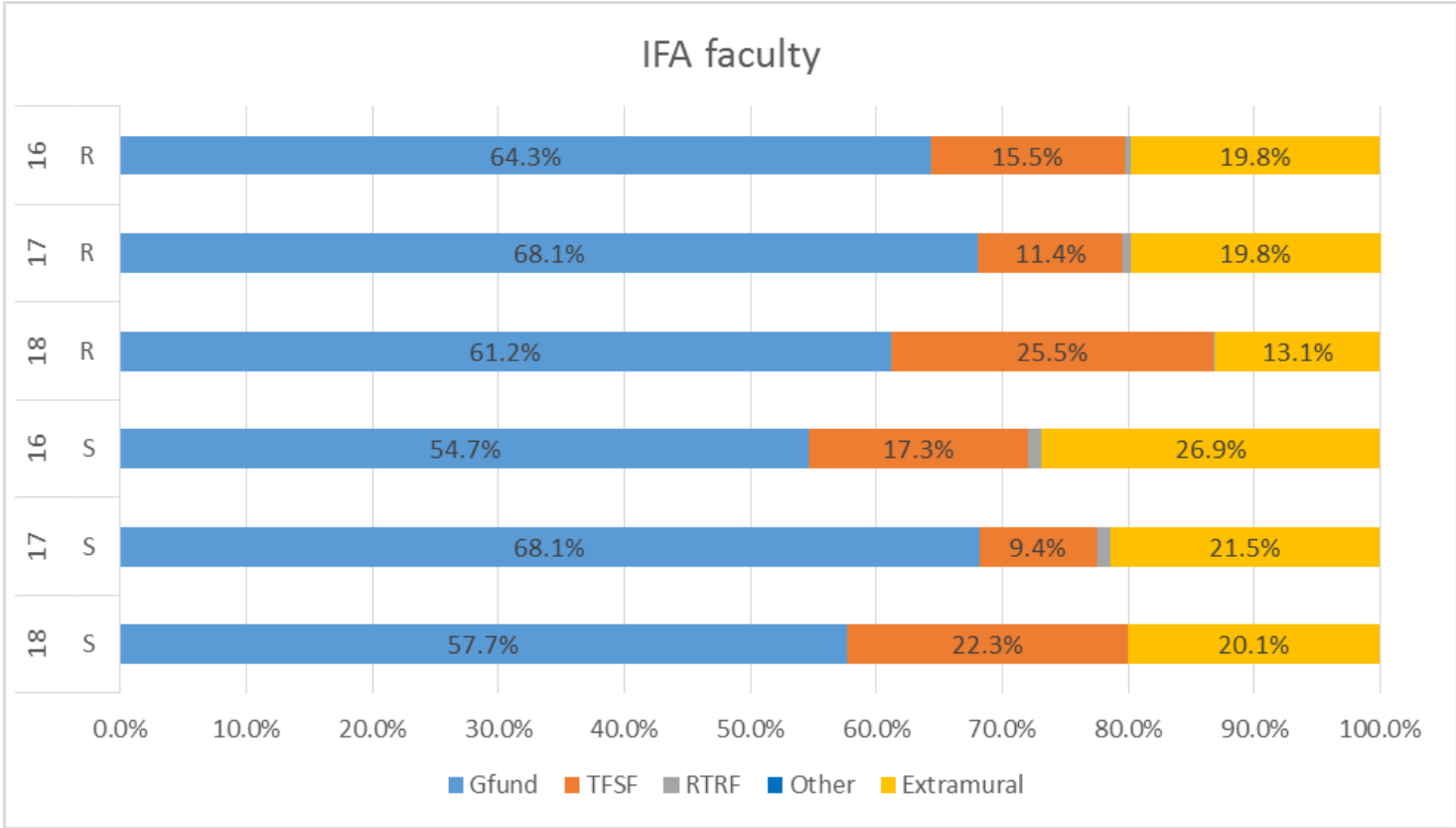



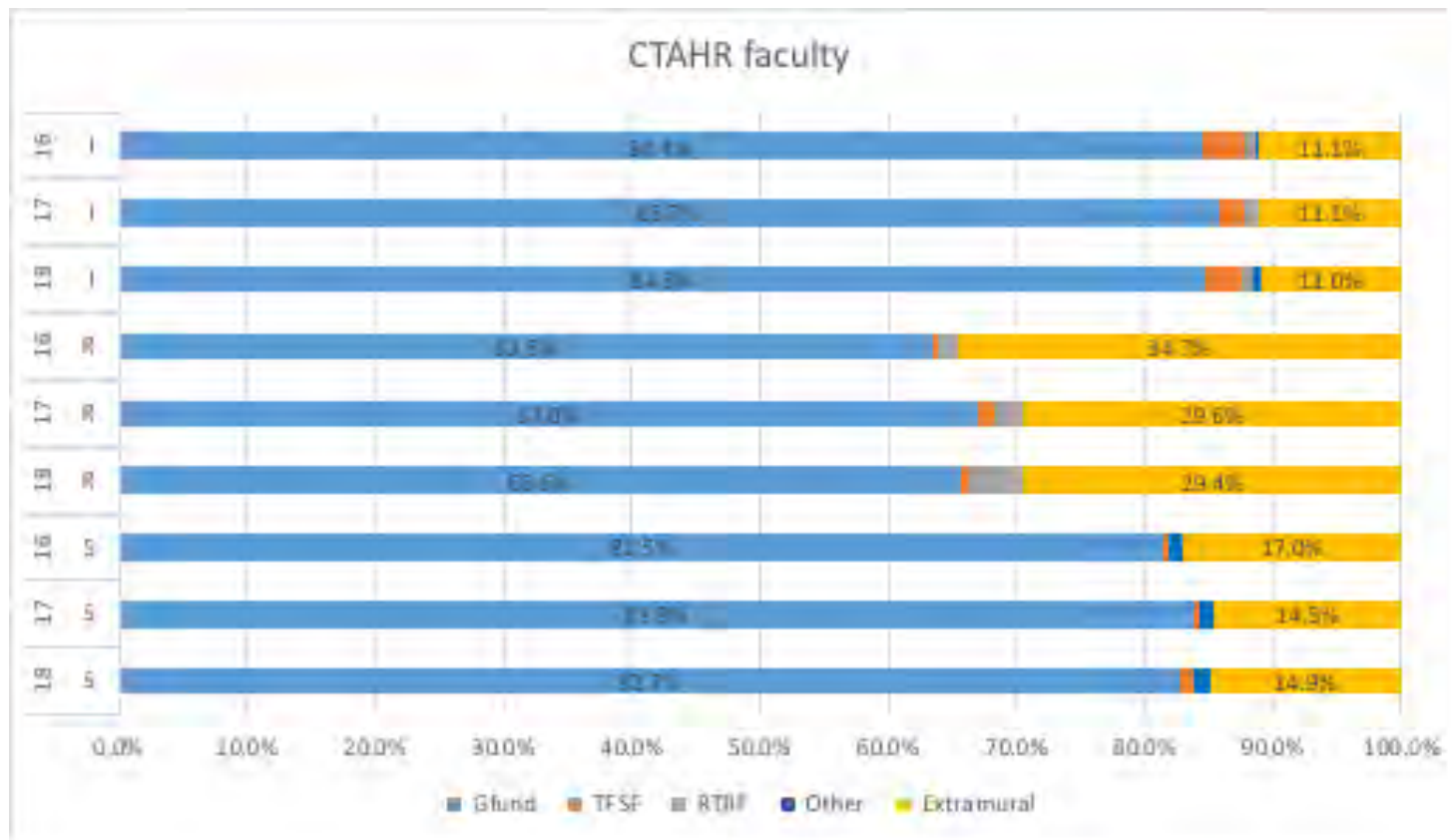

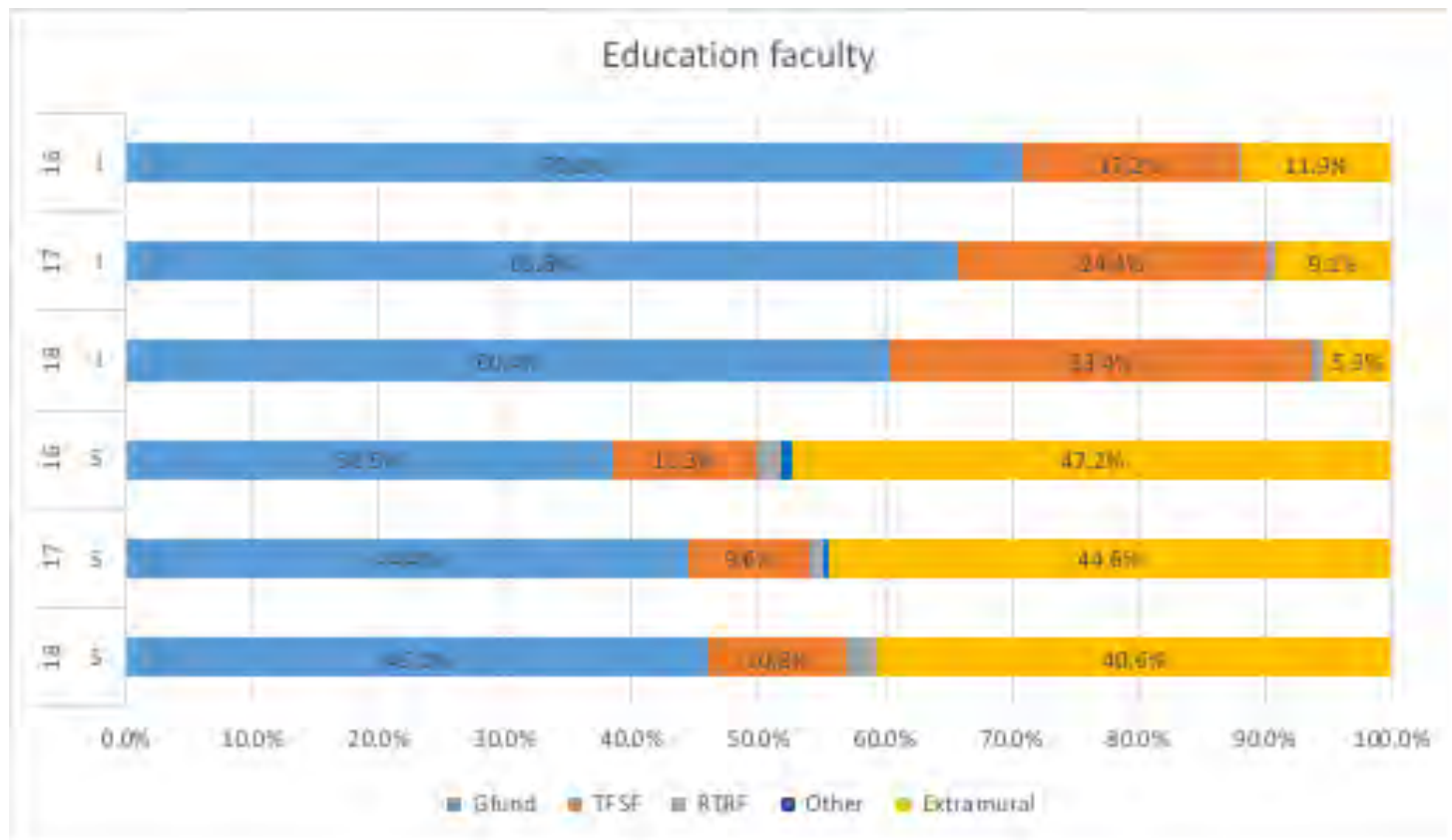

# Mānoa Innovation Center Update

---

BOR Research & Innovation Committee  
October 2018



# Background

---

- April 11, 1994 – The University of Hawai‘i (UH) and the Hawai‘i Technology Development Corporation (HTDC) entered into a 25-year lease agreement, under which UH, as the lessor, leased the Mānoa Innovation Center (MIC) property to HTDC.
- April 30, 2015 – MIC Ground Lease expired, and UH allowed HTDC to continue occupying the MIC property on a month-to-month tenancy under the holdover provision within the lease.
- January 22, 2018 – Notice of Termination of Holdover Tenancy sent to Department of business, Economic Development and Tourism (DBEDT) and HTDC.



# Background

---

- January 23, 2018 – Follow-up letter for Notice of Termination of Holdover Tenancy sent to HTDC
- January 24, 2018 – Notice sent to MIC tenants that UH System will be taking over management and administration of MIC effective July 1, 2018.
- February 2, 2018 – MIC Tenants meeting to discuss transition.
- June 1, 2018 – UH MIC Building Manager hired.
- June 27, 2018 – Property Manager Agreement for Services executed.
- July 1, 2018 – HTDC's holdover tenancy expired; UH assumed possession and control of the MIC property.



# Property Management Company Property Manager

---

- Agreement for Services was executed with Colliers International Hi Holdings LLC dba Colliers International Real Estate Management Services (HI) LLC
  - Effective July 1, 2018 to June 30, 2019 with the option to extend for two (2) additional one (1) year periods.
  - Agreement amount \$105,048
  - Property Manager – Chikako (Sam) Dold
  - Corporate Controller – Joy Funakoshi
- UH On-Site Building Manager – Lori Leong



# Current Tenants

<b>PHYSICAL</b>		<b>VIRTUAL</b>
3D Innovations	PICHTR	AEC Drones, LLC
Adnoviv	PV Tech	Bit Link Solutions
AMEL Technologies	RCUH - Small Business Development Center	Cythera Pharmaceuticals Inc.
Beaumont	RCUH - Veteran Business Outreach Center	ER3D
Blackhawk	Real Estate Strategies	GPNE Corp
Cardax Pharmaceuticals	Research Corporation of the University of Hawaii	HIT Methods
Corning Hawaii	Resurgo	Honolulu Options Traders
Dev League	Shifted Energy	Manageability LLC dba Bright Light Digital
Diagenetix	SOS	Mentors Guild
DraftecHI	Spectrum Photonics	MIWA Technologies
Financial Planning Hawaii	Start-up Capital	People Bridge
Hawaii Technology Development Corporation	Sudokrew	
HIEVODEVO	Sun Global	
Jun Innovations	Tritium3	
Kalvio Engineering	UH - Academy of Creative Minds	
Kuehnle	UH - Applied Research Laboratory	
Lesson Tracks	UH - P20	
Nalu Scientific	UH - STEM	



# Layout of MIC/Square footage

First Floor





# Layout of MIC/Square footage

Second Floor

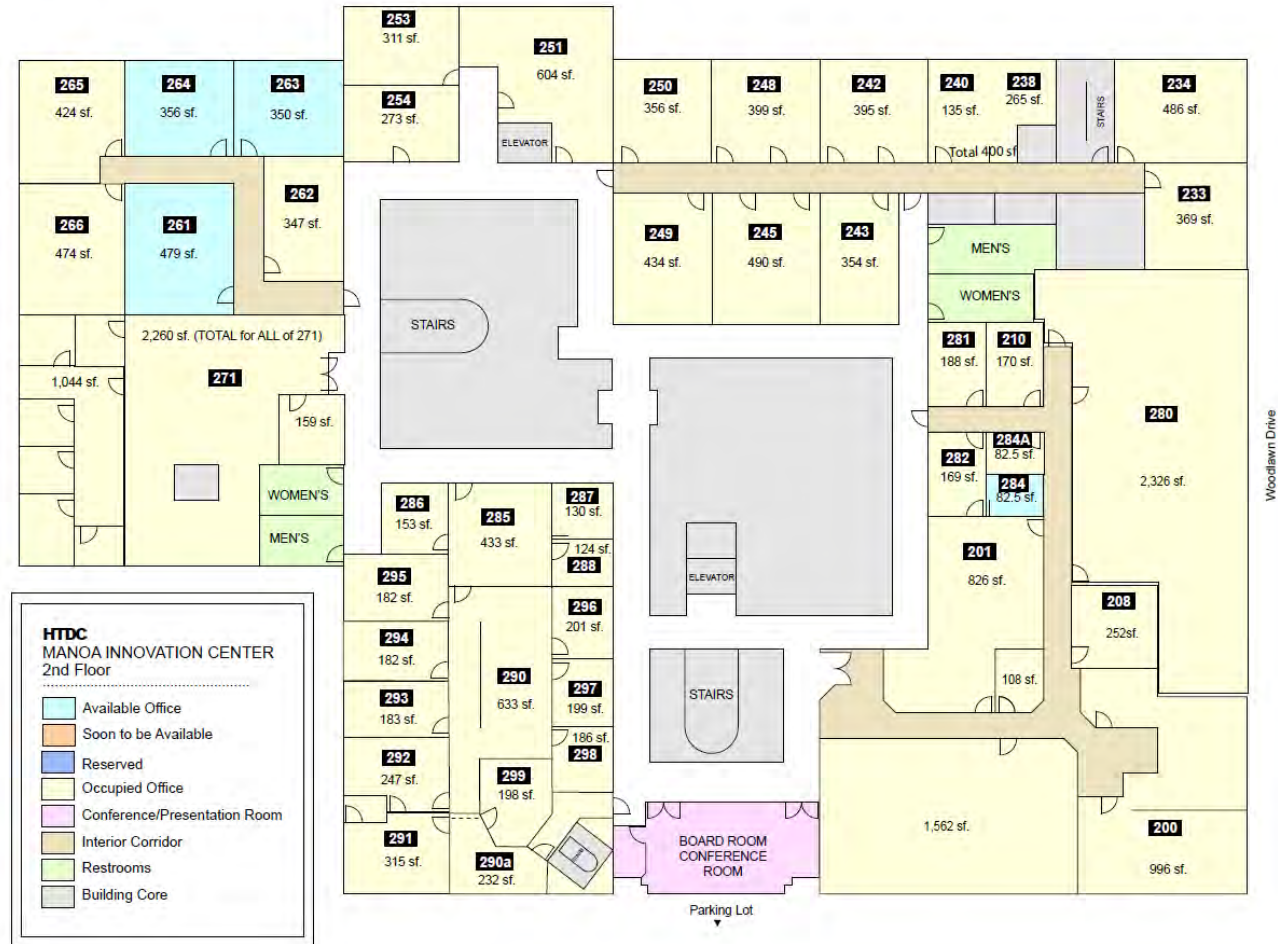

# Estimated Annual Income

## Operating Income and Expenses Projection

Total Income	\$1,455,000
Operating Expenses	\$695,000
Other Expenses (Non-Recoverable)	<u>- \$101,000</u>
Net Operating Income	\$659,000



**Item IV.B.1.**  
**Committee Goals &  
Objectives**

**MATERIALS**

**Committee Goals and Objectives**  
**Board of Regents Committee on Research & Innovation (Oct. 2018)**  
**University of Hawai'i**

1. Increase Research Funding: Evaluate methods to increase research funding and revise Board policies as appropriate. The Committee anticipates reviewing:
  - a. annual Grant/Proposal submission targets and possible multi-year targets/goals;
  - b. the Sustainability Institute as a strategic growth area; evaluating goals and execution plans, input on direction and high level issues;
  - c. the UHealthy Hawai'i Initiative as a strategic growth area;
  - d. the road map for Engineering and Computer Science as targeted areas of growth, with recommendations on changes needed to achieve goals;
  - e. review and evaluate the effectiveness of hiring policies (and related funding mechanisms) for research faculty;
  - f. evaluate the effectiveness of existing metrics in light of goals and objectives.
  
2. Support Faculty in Growth of the Research Base: Evaluate methods to assist faculty in growing the research base and revise Board policies as appropriate. The Committee anticipates reviewing:
  - a. Establishment of a grant support office, services necessary to support new faculty in successful grant writing, and methods of funding additional support;
  - b. Reviewing programs and funding mechanisms to incentivize high risk, early stage research (pre-grant stage), reviewing such programs at other universities and evaluating institutionalizing a process.
  
3. Transform Facilities and Programs to promote Innovation and Collaboration. Evaluate facility issues that impede innovation and collaboration within the university. The Committee anticipates it will:
  - a. Evaluate the establishment of a comprehensive Innovation Hub that would include collaboration between existing and/or planned facilities and programs including, but not limited to: Atherton, Holmes Hall, ilab, Manoa Innovation Center.
  - b. Review and evaluate the programs and methods that will be utilized to increase students' exposure to developing skill sets to thrive in the new economy: creative competency, entrepreneurship and innovation